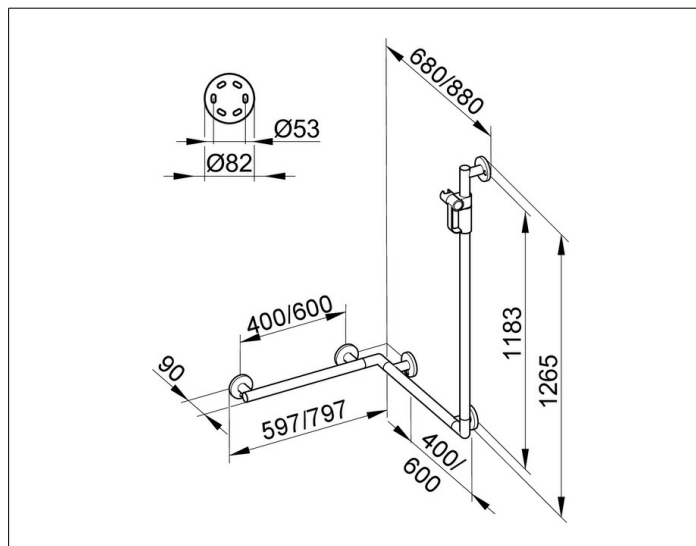

Plan Care

34908174411 Поручень вдоль стены и штанга для душа

ИЗДЕЛИЕ**ЧЕРТЕЖ****ОПИСАНИЕ ИЗДЕЛИЯ**

в комплекте с держателем душевой лейки
монтируется справа и слева

ПОВЕРХНОСТЬ

алюминий анодированный(E6 EV1)/хром

ГАБАРИТЫ

597/680/1265 mm

СПЕЦИФИКАЦИИ

KEUCO PLAN CARE rail system
with Shower rail 34908174411,
Aluminium silver-anodized/chrome-plated
complete with shower bracket,
may be used on left or right
in esthetic, practical and ergonomic Design
as Support help up to 115 kg load capacity,
anti-static,
easy to clean
Base measurement horizontal 400/400/1182 mm,
Pipe diameter 33 mm,
5 Rosette Diameter 82 mm
Measurement 597/680/1265 mm
Projection 90 mm,
Wall distance 57 mm

May be combined with tip-up seat with backrest
(Art. no. 34981) or spray guard (Art. no. 34940)

Included in delivery:
5 x mounting set1 (Art. no. 34990000100)

Further mounting sets
(depending on type of wall):
5 x mounting set 4 (Art. no. 34990 000200), or
5 x mounting set 7 (Art. no. 34993 000200)
Please order additionally!