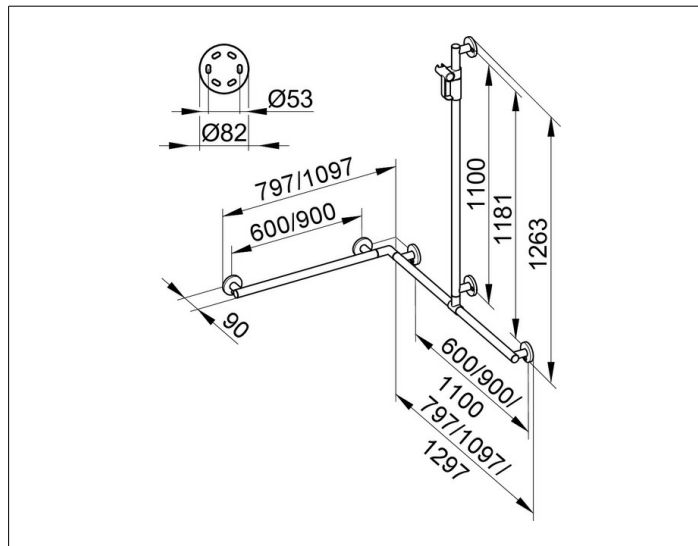

Plan Care**34915176611** Поручень вдоль стены и штанга для душа**ИЗДЕЛИЕ****ЧЕРТЕЖ****ОПИСАНИЕ ИЗДЕЛИЯ**

в комплекте с держателем душевой лейки
устанавливаемая по выбору справа или слева
положение душ.штанги
перед монтажом произвольное

ПОВЕРХНОСТЬ

алюминий анодированный/хром

ГАБАРИТЫ

797/797/1263 mm

СПЕЦИФИКАЦИИ

KEUCO PLAN CARE Shower handle,
Angle / T-Shape and Shower rail
34915176611
Aluminium silver anodized/chrome-plated
complete with shower bracket,
in esthetic, practical and ergonomic Design
may be used on the left or right
flexible positioning of sliding rail
prior to final installation
help up to 115 kg load capacity
anti-static,
easy to clean
Base measurement 600/600/1100 mm
Measurements: 797/797/1263 mm
Pipe diameter 33 mm,
6 Rosette Diameter 82 mm
Extendable 90 mm,
Wall distance 57 mm

May be combined with tip-up seat with backrest
(Art. no. 34981) or spray guard (Art. no. 34940)

Included in delivery:
6 x mounting set1 (Art. no. 34990000100)

Further mounting sets
(depending on type of wall):
6 x mounting set 4 (Art. no. 34990 000200), or
6 x mounting set 7 (Art. no. 34993 000200)
Please order additionally!