

RY00119/1

RY00119/2

FLOW REDUCER  
(riduttore portata)  
4 l/m

7

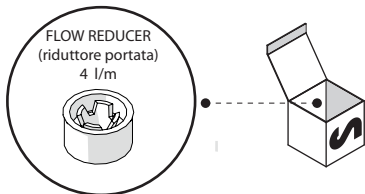

ON 100%

FLOW (portata) 4 l/m

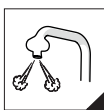
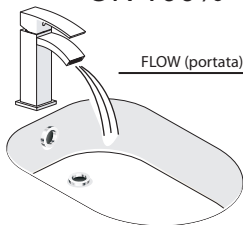
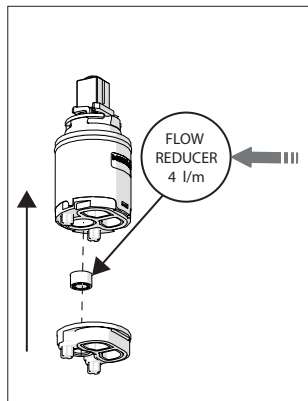

VARIE POSSIBILITA' PER SMONTARE L'AERATORE  
SEVERAL OPTIONS FOR REMOVING AERATOR

9

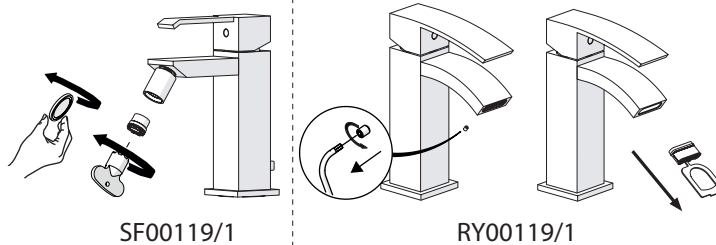

SF00119/1

RY00119/1

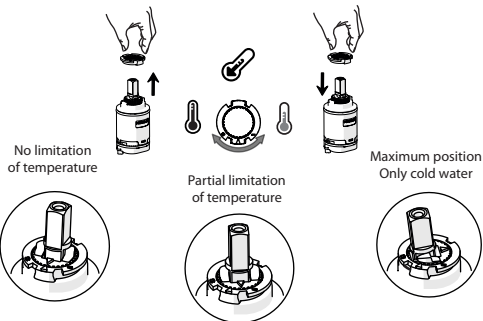

No limitation  
of temperature

Partial limitation  
of temperature

Maximum position  
Only cold water

**NOBILIS**

The Best Technology for Water

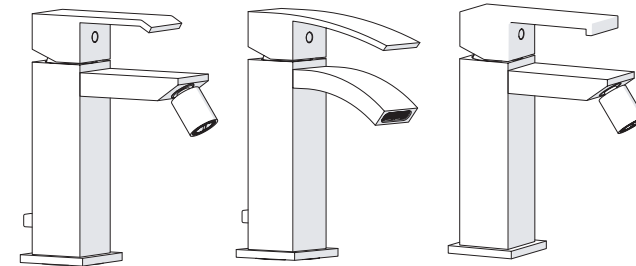

SF00119/1

RY00119/1

MI102119/1

SF00119/2

RY00119/2

MI102119/2

SL00119/1

SL00119/2



8

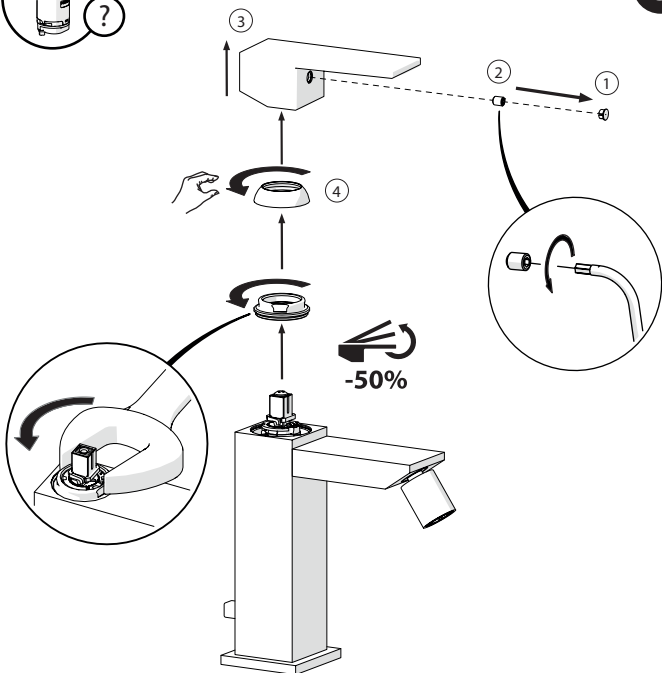

-50%



ESEMPIO DISEGNO TECNICO  
EXAMPLE OF TECHNICAL DRAWING

10

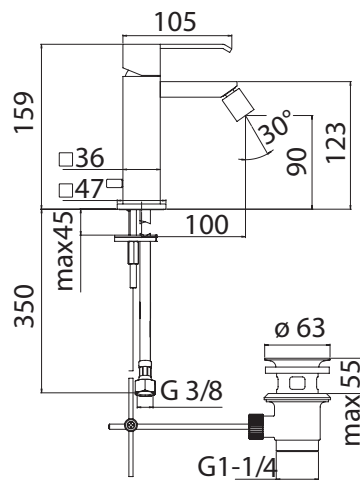

SF00119/1



www.grupponobili.it

PRIMA DI INIZIARE / BEFORE STARTING



PULIZIA / CLEANING

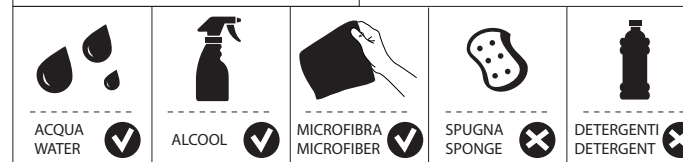

IISTR5F00119#---STD



REV2.08/2015

