

Not included / Non incluso / Non Inclus / Nie zawarty/ No incluido / Nao incluido

1

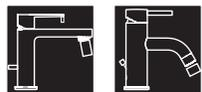

A1



A2

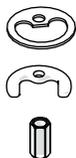

D1



D2

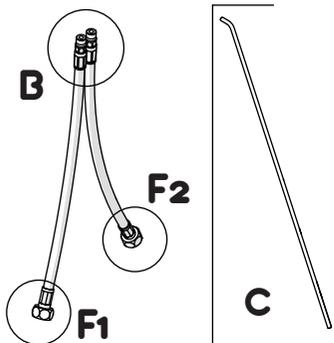

B

F2

F1

C

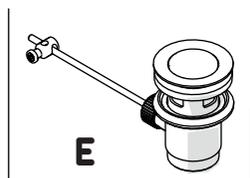

E

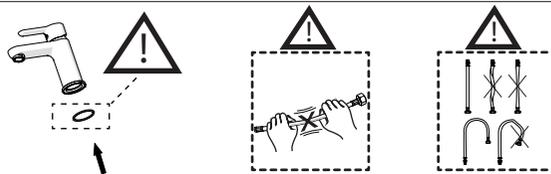

2

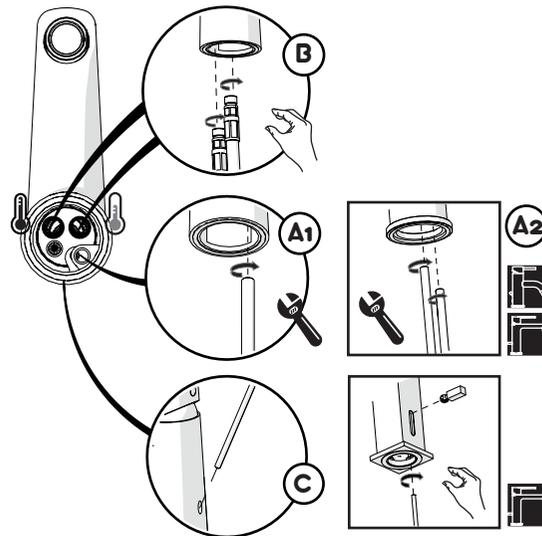

D1



D2

3

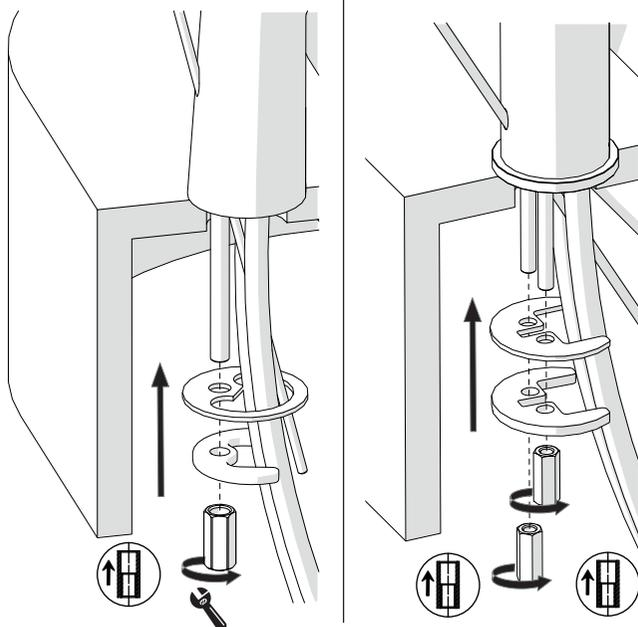

4

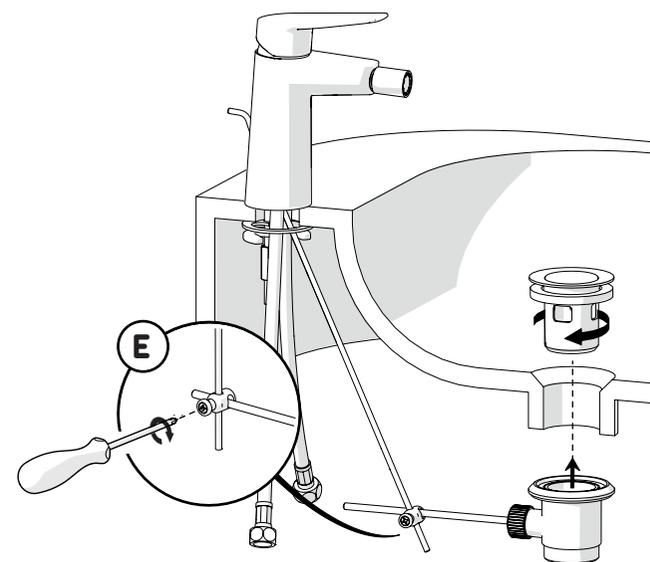

E

5

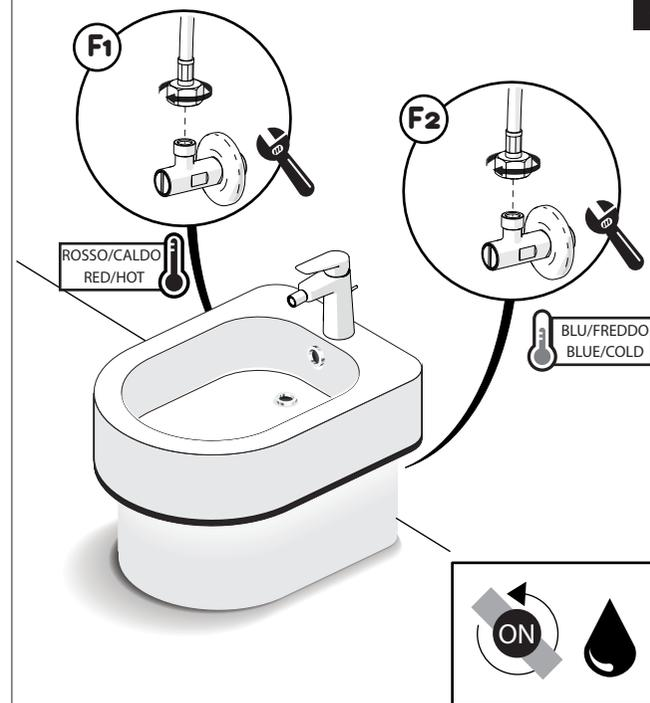

F1

F2

ROSSO/CALDO  
RED/HOT

BLU/FREDDO  
BLUE/COLD

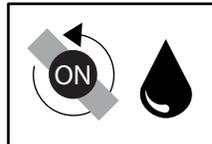

**-50%**

Dispositivo limitatore "dinamico"  
della portata d'acqua "50%"

"Dinamic" flow rate restrictor "50%"



CLOSE

**ECO**

ON 50%

ON 100%

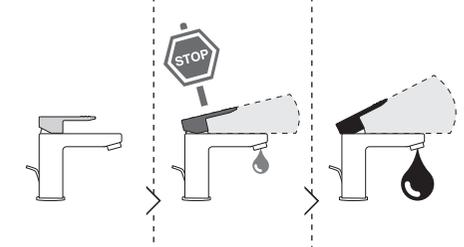

Posizione di chiusura    Posizione di risparmio acqua "50% portata"    Posizione di apertura totale 100% portata

Closed position

Position of water saving "50% capacity"

100% Fully open flow

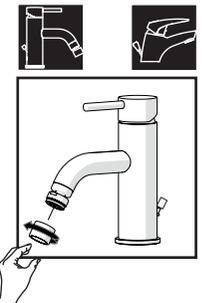
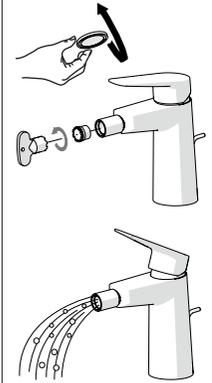
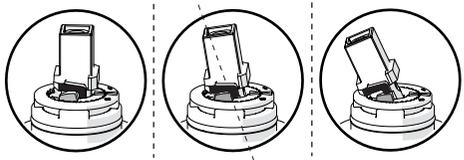

ESEMPI DISEGNO TECNICO  
EXAMPLES OF TECHNICAL DRAWING

**6**

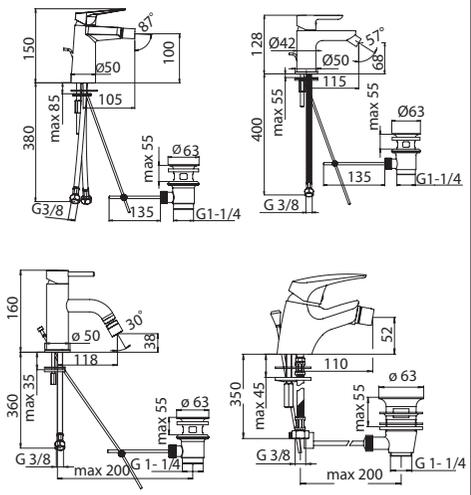

119

GENERICA/GENERIC

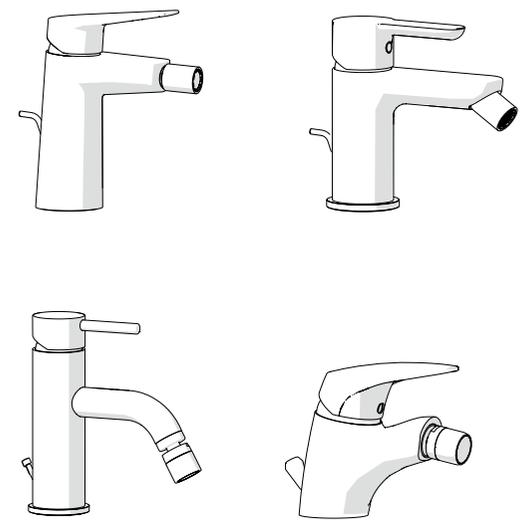

**7**

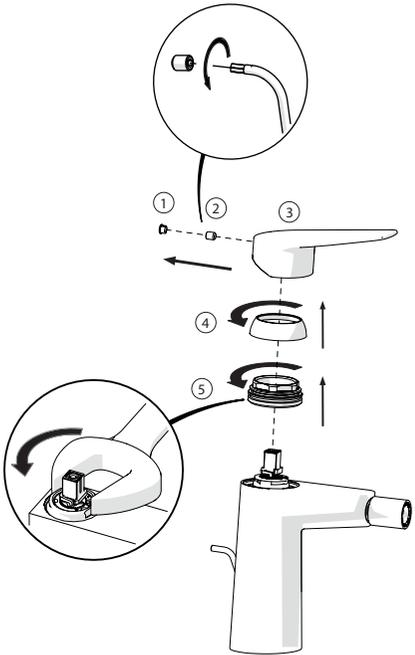
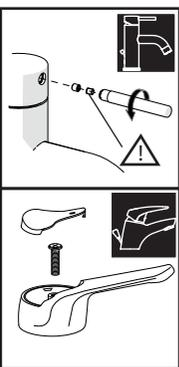

Per limitare la temperatura estrarre il limitatore e riposizionarlo nella posizione che si desidera

**8**

Extract the limiter and put it in correct position to limit temperature

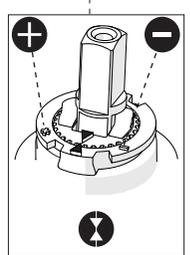
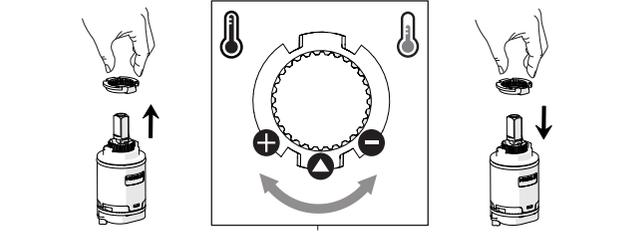

Nessuna limitazione di temperatura  
No limitation of temperature

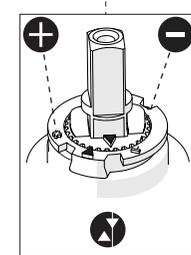

Limitazione parziale di temperatura  
Partial limitation of temperature

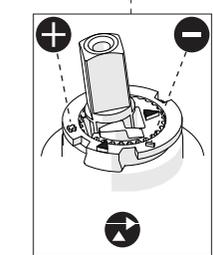

Massima limitazione Solo acqua fredda  
Maximum position Only cold water



www.grupponobili.it

PRIMA DI INIZIARE / BEFORE STARTING

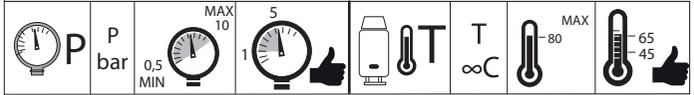

PULIZIA / CLEANING



IISTR00119#---STD



REV2.10/2015