

**Edition 400**

**51516010202 Single lever basin mixer**

**PRODUCT**



**DRAWING**

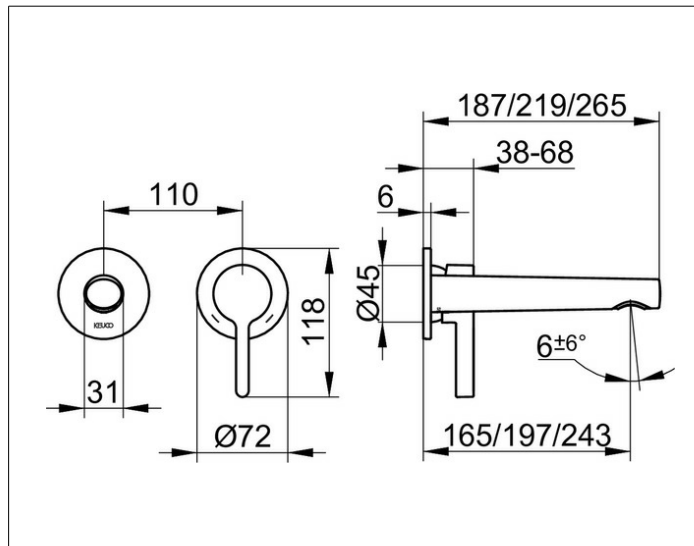

**PRODUCT ATTRIBUTES**

concealed, DN 15,  
 mixing cartridge with ceramic sealing gaskets  
 temperature controlled  
 aerator SLIM SSR M 24x1, adjustable,  
 flow rate limited to 7,6 l/min.  
 in combination with rough part 59916 000070

**SURFACE**

chrome-plated

**DIMENSION**

Ausladung 265 mm

**SPECIFICATIONS**

KEUCO Edition 400 single lever basin mixer, 51516010202  
 chrome-plated single lever basin mixer,  
 sculptural design, concealed, DN15,  
 high quality mixing cartridge with ceramic sealing gaskets,  
 temperature controlled,  
 rosette diameter 72 mm,  
 diameter spout at the aerator 31 mm,  
 aerator SLIM SSR M 24x1, adjustable  $\pm 6^\circ$ ,  
 total height control element 118 mm,  
 width 182 mm, total depth 265 mm,  
 flow rate limited to 7,6 l/min.

Note:  
 suitable rough part Art.-No. 59916000070