

- DE** Gebrauchsanleitung / Montageanleitung
FR Mode d'emploi / Instructions de montage
EN Instructions for use / assembly instructions
IT Istruzioni per l'uso / Istruzioni per Installazione
ES Modo de empleo / Instrucciones de montaje
NL Gebruiksaanwijzing / Handleiding
DK Brugsanvisning / Monteringsvejledning
PT Instruções para uso / Manual de Instalação
PL Instrukcja obsługi / Instrukcja montażu
CS Návod k použití / Montážní návod
SK Návod na použitie / Montážny návod
ZH 用户手册 / 组装说明
RU Руководство пользователя /
Инструкция по монтажу
FI Käyttöohje / Asennusohje
SV Bruksanvisning / Monteringsanvisning
LT Vartotojo instrukcija / Montavimo instrukcijos
HR Upute za uporabu / Uputstva za instalaciju
TR Kullanım kılavuzu / Montaj kılavuzu
RO Manual de utilizare / Instrucțiuni de montare
EL Οδηγίες χρήσης / Οδηγία συναρμολόγησης
SL Navodilo za uporabo / Navodila za montažo
ET Kasutusjuhend / Paigaldusjuhend
LV Lietošanas pamācība / Montāžas instrukcija
SR Uputstvo za upotrebu / Uputstvo za montažu
NO Bruksanvisning / Montasjeveiledning
BG Инструкция за употреба /
Ръководство за монтаж
SQ Udhëzuesi i përdorimit / Udhëzime rreth montimit
AR دليل الاستخدام / تعليمات التجميع
HU Használati útmutató / Szerelési útmutató
JP 取扱説明書 / 施工説明書

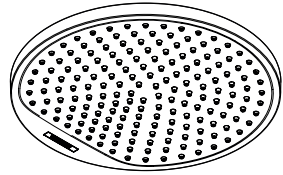

Crometta S 240 1jet
26723XXX
Crometta S 240 1jet Eco
26724XXX

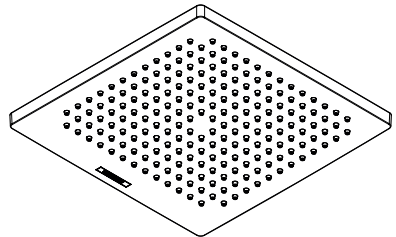

Crometta E 240 1jet
26726XXX
Crometta E 240 1jet Eco
26727XXX



Crometta S 240 1jet 26723XXX
Crometta S 240 1jet Eco 26724XXX

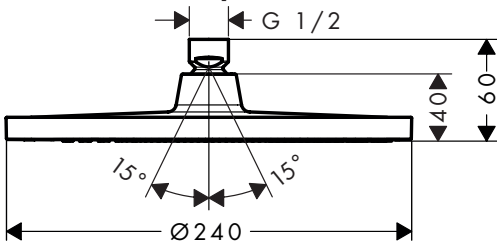

Crometta E 240 1jet 26726XXX
Crometta E 240 1jet Eco 26727XXX

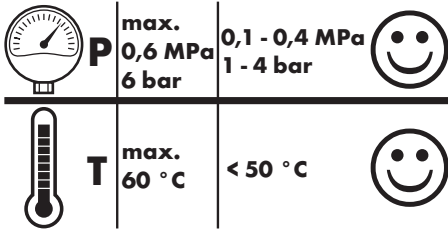
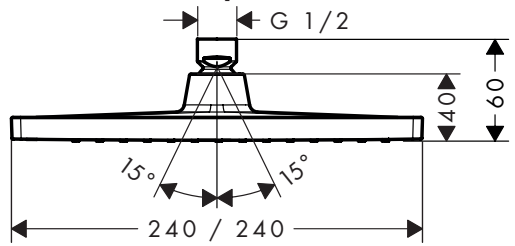

Crometta S 240 1jet 26723XXX

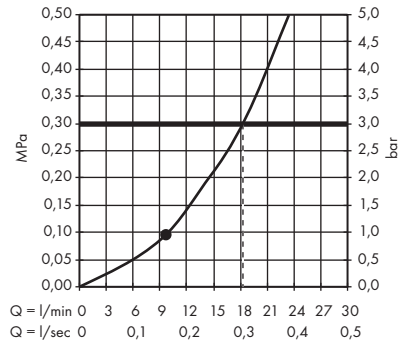

Crometta E 240 1jet 26726XXX

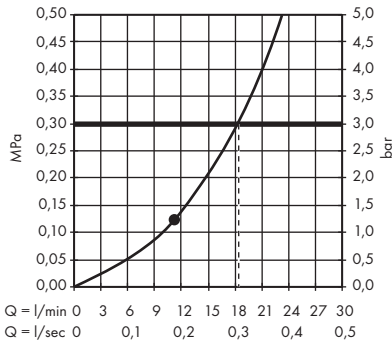

Crometta S 240 1jet Eco 26724XXX

Crometta E 240 1jet Eco 26727XXX

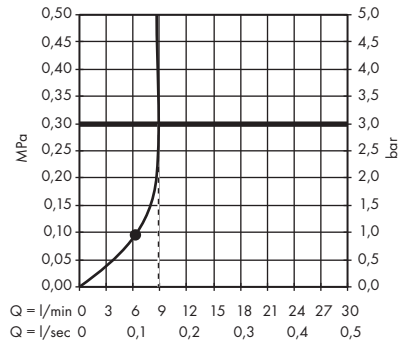

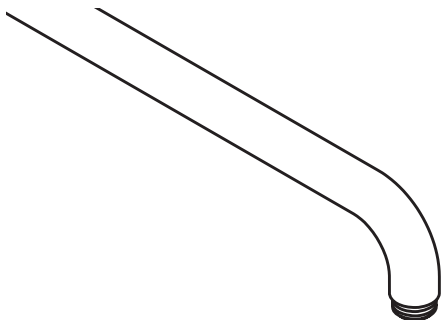

 #94246000

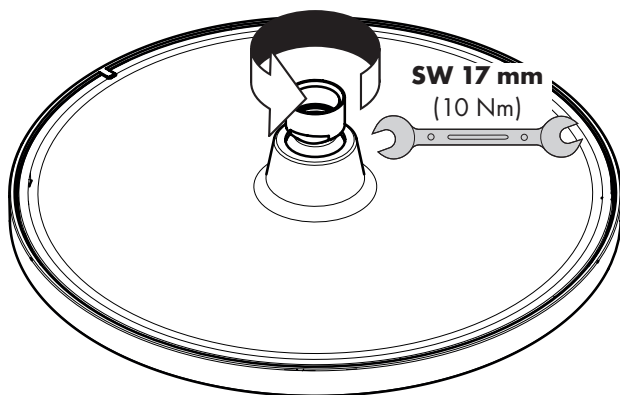

P-IX

DVGW SINTEF NF



ETA



GODKENDT
TIL DRILLEKAVAND

26723XXX	P-IX 29847/IB	X
26724XXX	P-IX 29848/IIZ	X
26726XXX	P-IX 29849/IB	X
26727XXX	P-IX 29850/IIZ	X

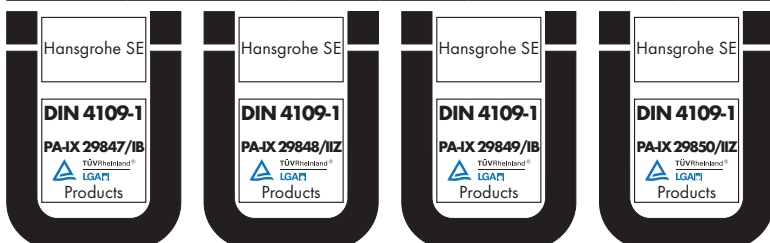



- DE** Reinigungsempfehlung / Garantie / Kontakt
FR Recommandation pour le nettoyage / Garanties / Contact
EN Cleaning recommendation / Warranty / Contact
IT Raccomandazione di pulizia / Garanzia / Contatto
ES Recomendaciones para la limpieza / Garantía / Contacto
NL Aanbevelingen inzake reiniging / Garantie / Contact
DK Rengøringsvejledning / Garanti / Kontakt
PT Recomendações de limpeza / Garantia / Contacto
PL Zalecenie dotyczące pielęgnacji / Gwarancja / Kontakt
CS Doporučení k čištění / Záruka / Kontakt
SK Odporúčania pre čistenie / Záruka / Kontakt
ZH 清洁指南 / 担保 / 接触
RU Рекомендации по очистке / Гарантия / Контакты
FI Puhdistussuositus / Takuu / Kosketus
SV Rengöringsrekommendationer / Garanti / Contacto
LT Valymo rekomendacijos / Garantija / Kontaktai
HR Preporuke za čišćenje / Garancija / Kontakt
TR Temizleme önerisi / Garanti / Temas
RO Recomandări pentru curățare / Garanție / Contact
EL Σύσταση καθαρισμού / Εγγύηση / επαφή
SL Priporočilo za čiščenje / Garancija / Kontakt
ET Puhastussuovitused / Garantii / Kontakt
LV Tīrīšanas ieteikumi / Garantija / Kontakti
SR Preporuke za čišćenje / Garancija / Kontakt
NO Anbefaling for rengjøring / Garanti / Kontakt
BG Препоръка за почистване / Гаранция / Контакт
SQ Këshilla rreth pastrimit / Garancia / Kontakt
KO 세정시 권장사항 / 품질보증 / 접촉
AR توصيات التنظيف / الضمان (الولايات المتحدة الأمريكية) / اتصال
HU Tisztítási tanácsok / Garancia / érintkezés
JP お手入れの方法 / 保証について / ご連絡先



[www.hansgrohe.com/
cleaning-recommendation](http://www.hansgrohe.com/cleaning-recommendation)

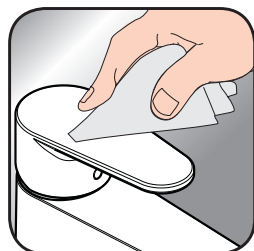

[www.hansgrohe.com/
cleaning-recommendation](http://www.hansgrohe.com/cleaning-recommendation)



[www.hansgrohe.com/
cleaning-recommendation](http://www.hansgrohe.com/cleaning-recommendation)



[www.hansgrohe.com/
cleaning-recommendation](http://www.hansgrohe.com/cleaning-recommendation)

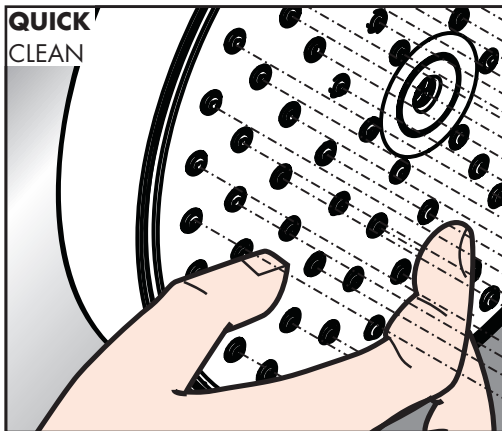

- DE** Einfach sauber: Kalk lässt sich von den Noppen ganz leicht abrubbeln.
- FR** La propreté en toute simplicité: les dépôts formés sur les buses élastiques en silicone s'éliminent par un simple passage de la main.
- EN** Just clean: simply rub over the spray nozzles to remove lime scale.
- IT** Facile da pulire: Il calcare viene eliminato semplicemente dagli ugelli elastici in silicone.
- ES** Fácil aseó: La cal se puede retirar sencillamente frotando con los dedos de las toberas elásticas de silicona.
- NL** Eenvoudig schoon: Kalk kan eenvoudig van de noppen worden gewreven.
- DK** Enkel rengøring: Det er let at fjerne kalkaflejringer fra stråledyserne.
- PT** Simplesmente limpo: o calcário pode ser simplesmente retirado das saliências através de fricção.
- PL** Po prostu czysto: Pęczki można całkiem łatwo oczyścić z kamienia.
- CS** Jednoduše čistě: Vapenné usazeniny můžete z popků snadno odstranit otřením.
- SK** Jednoducho čistý: Vodný kameň sa dá zo štetín celkom ľahko odstrániť.
- ZH** 清洁: 只需要揉搓花洒表面的出水孔即可去除水垢。
- RU** Простота чистки: известь очень легко стирается с утолщений.
- FI** Yksinkertaisesti puhdas: kalkin voi helposti hieroa irti nuppistä.

- SV** Enkelt att göra rent: det är lätt att ta bort kalk från popporna.
- LT** Paprasta švara: kalkės lengvai nugrandomos nuo kilpos.
- HR** Jednostavno čisto: Kamenac se sasvim lako uklanja s izbočina.
- TR** Sadece temiz: Kireç, düğümlemlerle kolayca ovalanabilir.
- RO** Pur și simplu curat: Calcarul se îndepărtează ușor de pe noduri prin frecare.
- EL** Απλά τέλεια καθαριότητα: Τα άλματα μπορούν να αφαιρεθούν με μεγάλη ευκολία από τα στόμια.
- SL** Preprosto čisto: arnenec se z lahkoto podrgne z vozličkov.
- ET** Lihtsalt puhas: lupja saab nuppuheldelt lihtsalt maha hõõruda.
- LV** Vienkārša tīrīšana: kalķis no izvīrzījumiem ir viegli norubināms.
- SR** Jednostavno čisto: Kamenac se sasvim lako skida sa izbočina.
- NO** Simpelten ren: Ved å gnikke er det lett å fjerne kalk fra nuppene.
- BG** Просто чисто: Варовикът лесно може да се изтърси от удебеленията.
- SQ** Thjesht dhe pastër. Mbetjet qëqerore mund të hiqen me fërkim të lehtë.
- AR** إنه سهل التنظيف، حيث يسقط الجير بسهولة شديدة من الأجزاء الناتئة
- HU** Egyszerűen tiszta: a vízkő egészen könnyen ledörzsölhető a csomókról.
- JP** 清掃が簡単: カルキは突起部から簡単にこすり落とすことができます。

