

-50%

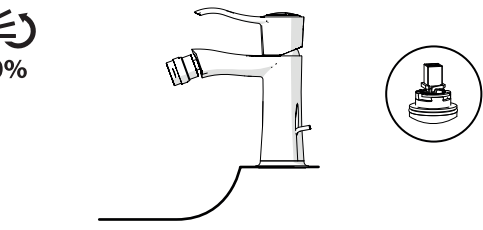

7

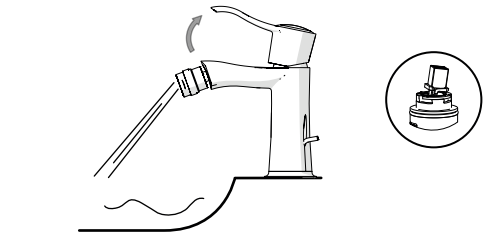

ON 50%

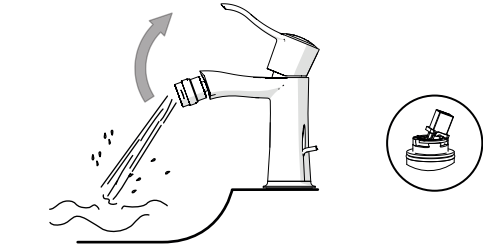

ON 100%



Per limitare la temperatura estrarre il limitatore e riposizionarlo nella posizione che si desidera

Extract the limiter and put it in correct position to limit temperature

9

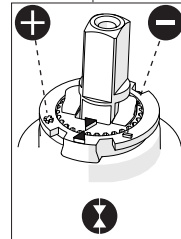
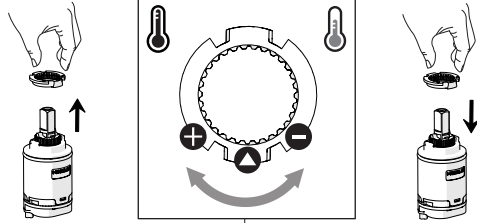

Nessuna limitazione di temperatura

No limitation of temperature

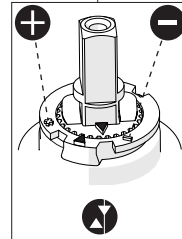

Limitazione parziale di temperatura

Partial limitation of temperature

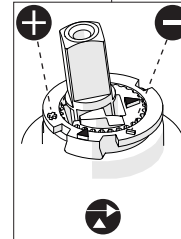

Massima limitazione Solo acqua fredda

Maximum position Only cold water

NOBILIS®
The Best Technology for Water

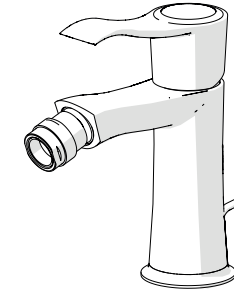

SI98119/1



www.grupponobili.it

IISTR98119#---STD

REV1.09/2013

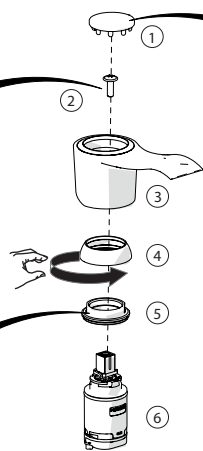
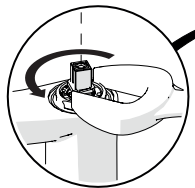
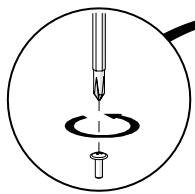

8

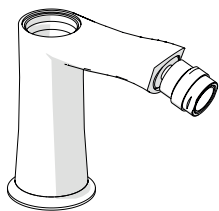

CLEANING

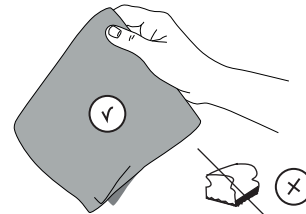

WATER



ALCOOL



X

10

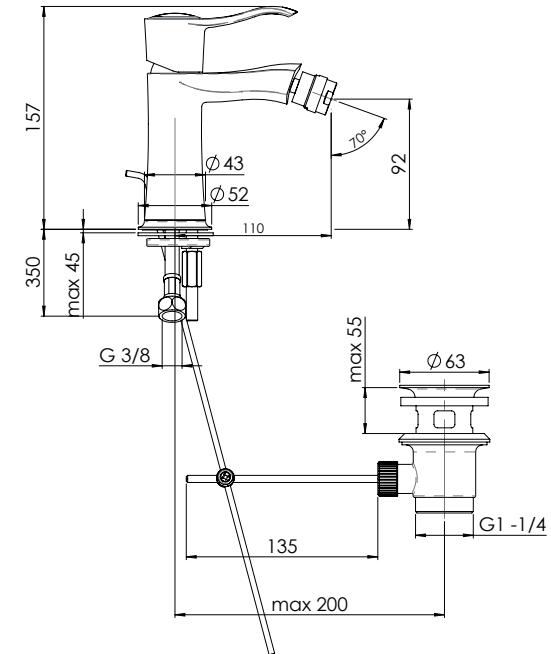

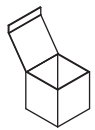

+



Not included / Non incluso / Non inclus / Nie zawarty/ No incluido / Não incluido



C

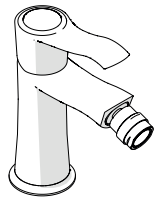

A

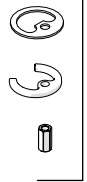

D

1

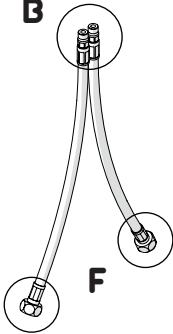

B

F

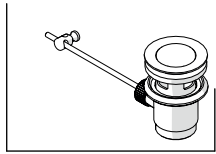

E

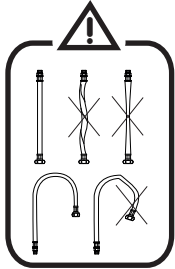

3

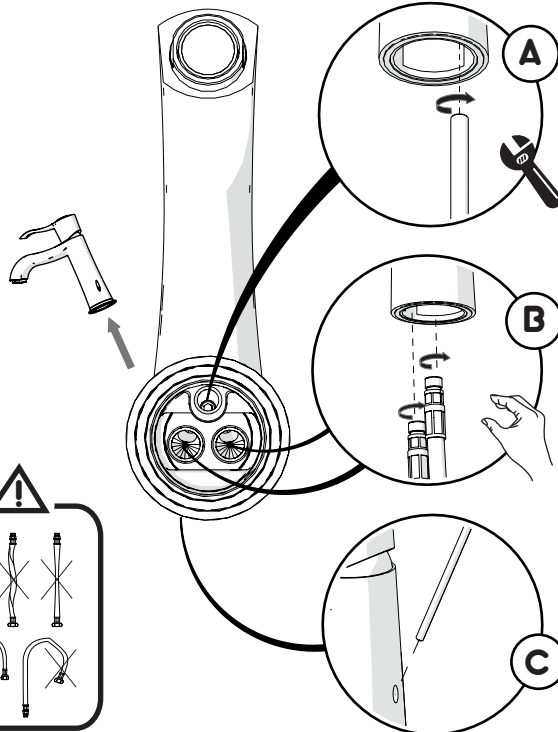

A

B

C

5

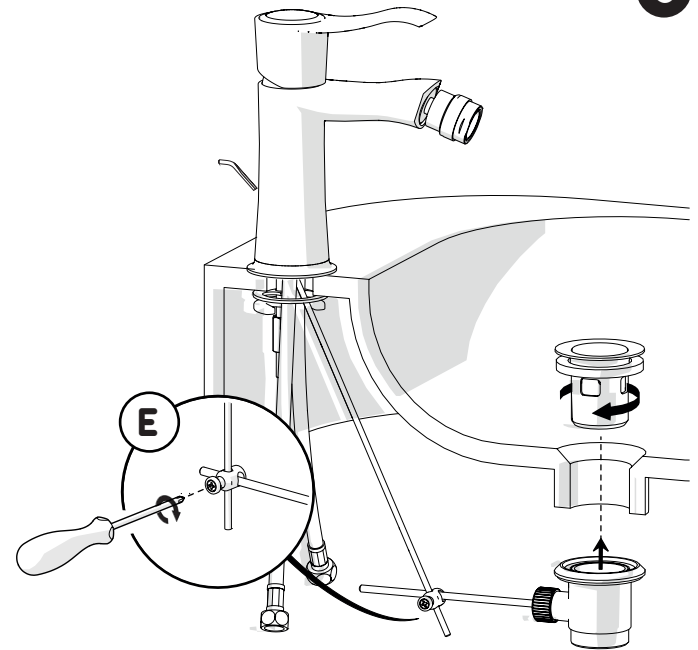

E

2

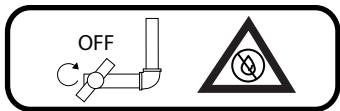
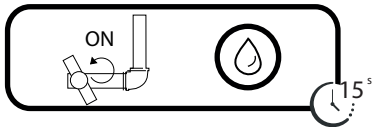

4

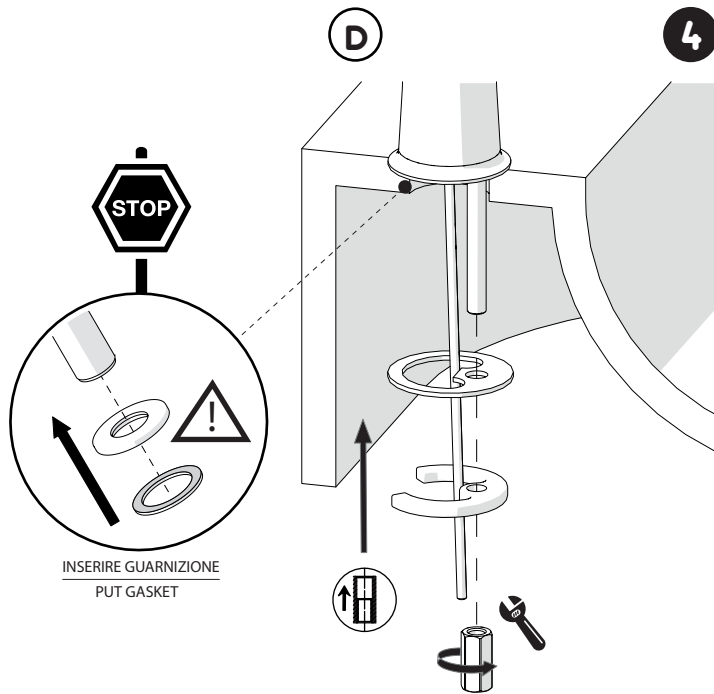

D

INSERIRE GUARNIZIONE
PUT GASKET

6

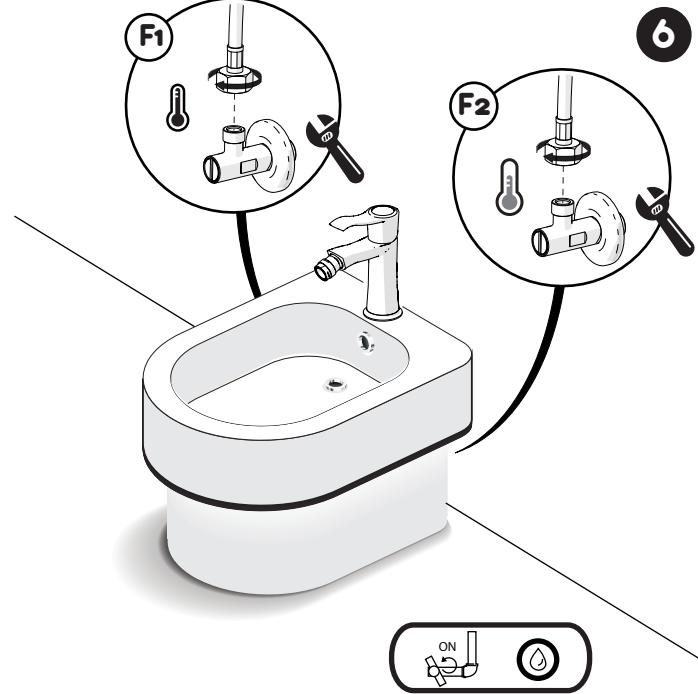

F1

F2

