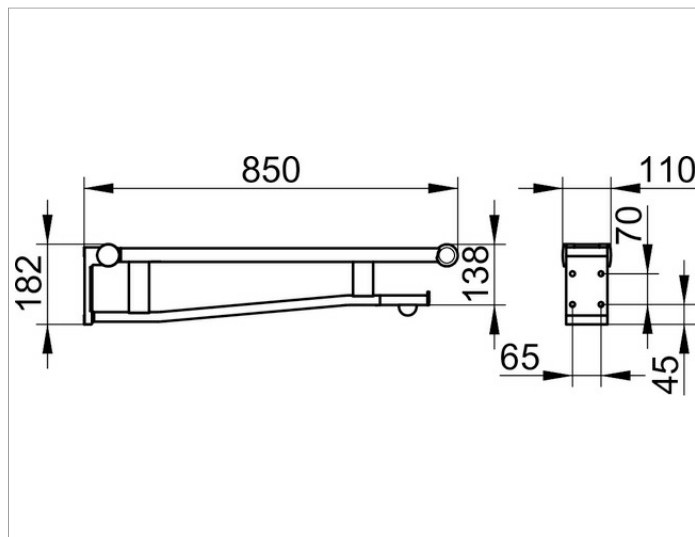

Plan Care**34903011837 Настенный поручень для туалета****ИЗДЕЛИЕ****ЧЕРТЕЖ****ОПИСАНИЕ ИЗДЕЛИЯ**

исполнение справа
со встроенным радиоуправляемым смывом для туалета,
в комплекте с сенсорной кнопкой и питанием от батареи
(SL-360 батарея LTC), подходит для:

Geberit:

115.867.00.1, 115.869.00.1, 115.897.00.1, 115.898.00.1

Grohe: 38 759 SD0

Sanit: 03.082.00..0000, 03.582.00..0000

Tece: 9.240.354, 9.240.355

Viega: 696 177

рукоятка откидывается вверх,

исполнение с огр. хода

поверхность контакта обшита пластиком,

со съемным держателем туал.бум.

поверхность

хром/темно-серый (RAL 7021)

Габариты

850 mm

спецификации

KEUCO PLAN Pivoted supporting rail for WC 34903011837
High shine chrome-plate pivoted supporting rail for WC
right hand model with integrated radio-controlled flush switch
complete with membrane keypad and battery power
(SL-360 LTC battery) fits with:

Geberit:

115.867.SN.5, 115.869.SN.5, 115.897.00.1, 115.898.00.1

Grohe:

38 759 SD0

Sanit:

03,082,00,,0000, 03,582,00,,0000

Tece:

9,240,354, 9,240,355

Viega:

611 965

handle folds upward, cushioned model,

support area with plastic covering,

dark-grey (RAL 7021)

with removable toilet paper holder (with roll brake)

anti-static

Width Surface area with anti-slip,

elegant,

tactile and optical contrasting Handle

Underneath as Hand towel holder useable

Projection 850 mm

Width Wall plate 110 mm,

Height Wall plate 182 mm

Load capacity up to 100 kg

The Handle is Type approved

Wall support grip will be at 4 places discretely mounted

It's essential for installation to order the correct
screws/bolts depending on type of wall:

2 x Mounting-Set 2 (item no. 34991000100) or

2 x Mounting-Set 5 (item no. 34991000200) or

2 x Mounting-Set 8 (item no. 34994000200) or

1 x Mounting-Set 10 (item no. 34996000100)

Please order separately!