

 **Nemox collection**

916507-06-60
Towel Rail 60 cm

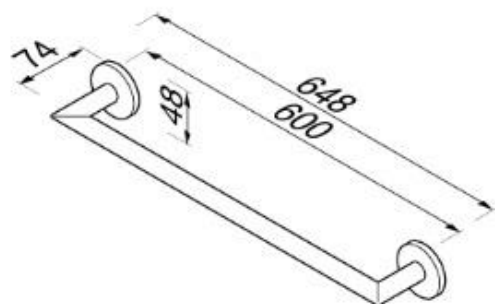

- Finish: matt black
- Concealed fixing
- Guarantee 5 year
- Material: stainless steel



- 648x74x48 mm

Quality has proven to be of decisive importance in recent years, which is why we can offer a 12-year warranty period for our chrome products. The entire selection is developed in Amersfoort. Geesa is certified according to the ISO 9001-2008 standard for design, productions and the delivery of bathroom accessories. 07/2018
