

# VELIS 62x48

**CATALANO**  
THE ESSENCE OF CERAMICS

cod. 162VL00

Installazione sospesa, semincasso o su mobile.  
*Suitable for wall-hung, semi fitted or cabinet installation.*  
*Installation hängend, halbeingebaut, auf Möbel installierbar.*

cod. 5P60VL00

Portasciugamani in ottone cromato.  
*Chrome brass towel rail.*  
*Handtuchhalter aus messing verchromt.*



**CE** EN 14688 - CL20

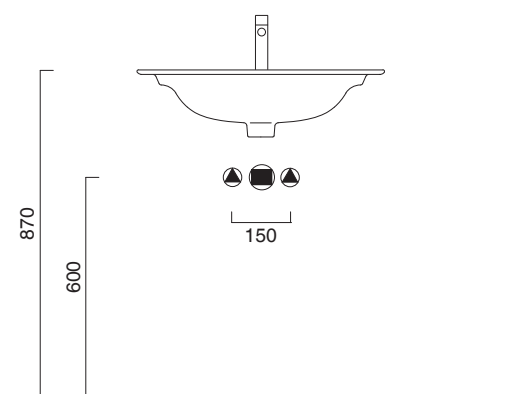
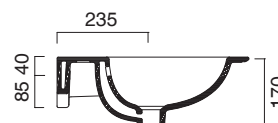
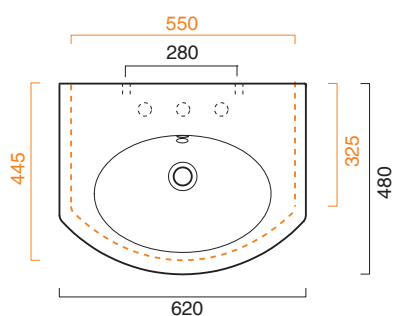

Tutti i diritti sulla presente scheda appartengono a Ceramica Catalano S.p.A. in via esclusiva. È vietata la copia, la pubblicazione, la distribuzione o la riproduzione (anche parziale), se non autorizzata per iscritto.  
All rights in the present form belong exclusively to Ceramica Catalano S.p.A. It is strictly forbidden to copy, publish, distribute or reproduce it (including any partial reproduction), without prior written permission.

 MADE IN ITALY

## GARANZIA

Il rivenditore sostituirà i prodotti con difetti di fabbricazione entro due anni dalla consegna.

*Your retailer will replace products with faults of manufacturing within two years from delivery date.*

*Der Wiederverkäufer wird Produkte mit Fabrikationsfehlern innerhalb 2 Jahren seit Zustellung ersetzen.*

## PULIZIA

Si consiglia di pulire con acqua tiepida e detersivo non abrasivo.

*The maintenance has to be done with tepid water and not abrasive detergents.*

*Für die Reinigung empfiehlt sich lauwarmes Wasser und keine Scheuermittel zu verwenden.*

---

## DICHIARAZIONE DI PERFORMANCE - DOP No 14688

Scarica il documento al seguente link a lato:

*Click the link on the side to download the document:*

*Klicken Sie auf den Link zum Herunterladen des Dokuments:*

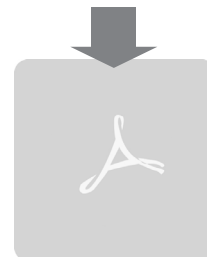

Antibacterial protection

**CATAglaze<sup>®</sup> + Silver Titanium**

**CATALANO**  
THE ESSENCE OF CERAMICS

MADE IN ITALY

L'INNOVATIVO SMALTO ANTIBATTERICO SU TUTTA LA CERAMICA  
THE INNOVATIVE ANTIBACTERIAL GLAZE IS STANDARD ON ALL  
CATALANO PRODUCTS.

L'ÉMAIL ANTIBACTÉRIEN NOVATEUR SUR TOUTE LA CÉRAMIQUE

**IT È un potenziamento dello smalto Cataglaze che, oltre a ridurre il deposito di calcare facilitando la pulizia dei sanitari ceramici, svolge una potente azione antimicrobica in grado di contrastare germi e batteri. L'efficacia della nuova formula è garantita dalla presenza nell'impasto di ioni d'argento e di titanio. L'azione antibatterica è certificata ISO 22196 con efficacia del 99,99%.**

**EN It is an improvement of Cataglaze glazing system; besides being more resistant to limescale and therefore easier to clean, it has a powerful antimicrobial action able to kill germs and bacteria. The effectiveness of the new formula is guaranteed by the presence in the mix of silver and titanium ions. The antibacterial action is ISO 22196 certified and it is 99.99% effective.**

**FR Il s'agit d'un renforcement de l'émail Cataglaze qui, en plus de réduire le dépôt de calcaire et donc faciliter le nettoyage des sanitaires en céramique, exerce une action antimicrobienne puissante en mesure de contraster les germes et les bactéries. L'efficacité de la nouvelle formule est garantie par la présence, dans le mélange, d'ions d'argent et de titane. L'action antibactérienne est certifiée ISO 22196 avec une efficacité de 99,99%.**



Silver Titanium  
Protezione antibatterica  
Silver Titanium  
Antibacterial protection  
Silver Titanium  
Protection antibactérienne

**99,99%**

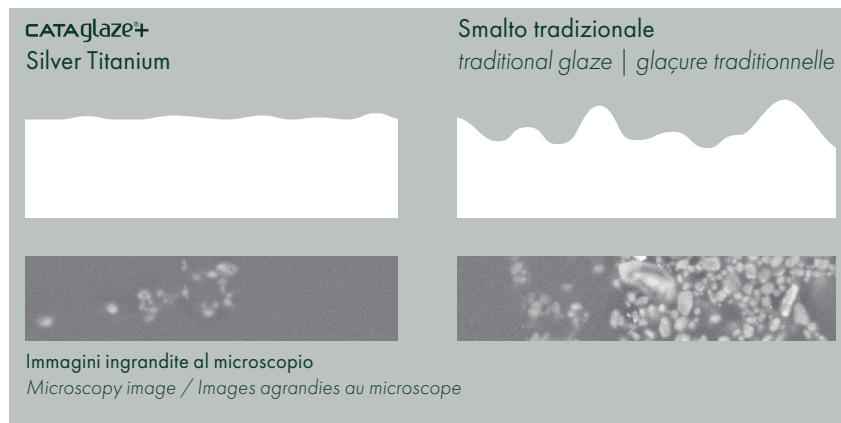

Maggiore brillantezza  
Brightness  
Aspect brillant



Resistenza agli agenti chimici  
Resistance to chemicals  
Résistant aux agents chimiques



Rispetto per l'ambiente  
Respect for the environment  
Respect de l'environnement



Pulizia facile e rapida  
Quick cleaning  
Nettoyage rapide



Igiene totale  
Total hygiene  
Hygiène totale



Lunga durata di vita  
Long lifecycle  
Longue durée

Tutti i diritti sulla presente scheda appartengono a Ceramica Catalano S.p.A. in via esclusiva. È vietata la copia, la pubblicazione, la distribuzione o la riproduzione (anche parziale), se non autorizzata per iscritto. All rights in the present form belong exclusively to Ceramica Catalano S.p.A. It is strictly forbidden to copy, publish, distribute or reproduce it (including any partial reproduction), without prior written permission.