

# XSquare

# # XS 4164

## Инструкция по монтажу

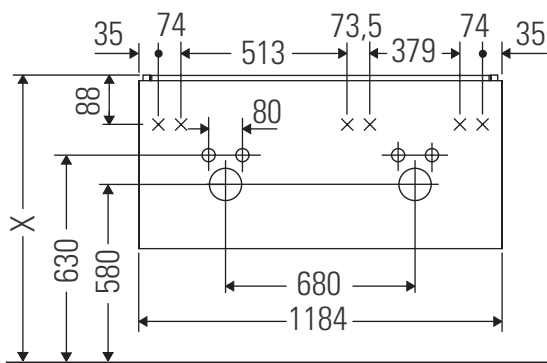

W mm	X mm
110	740

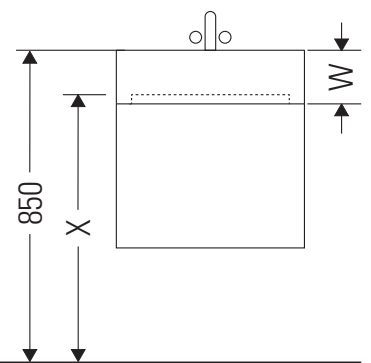

**DuraSquare # 235312**

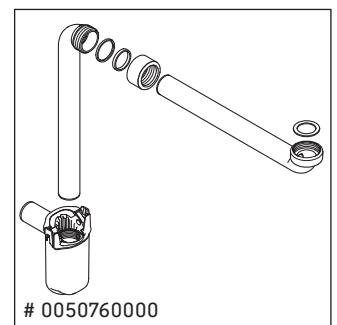
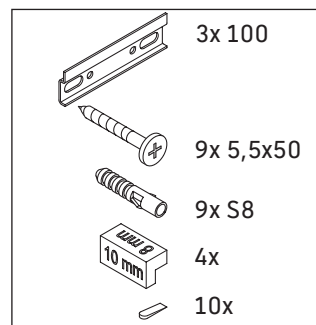
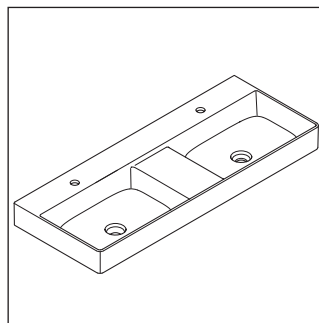
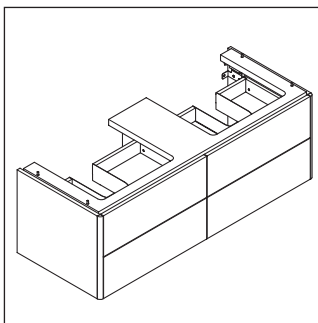

### Указания по применению

Серия мебели для ванной комнаты соответствует действующим нормам и директивам на момент поставки и сконструирована для использования в ванных комнатах. Непосредственное орошение водой, например, во время мытья под душем следует избегать.

Мы оставляем за собой право на техническое усовершенствование и визуальные изменения изображенных изделий.

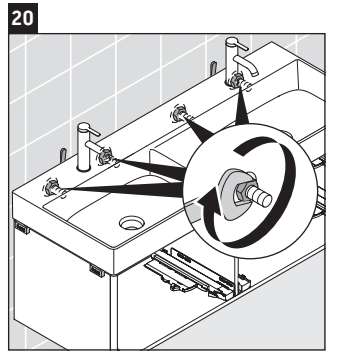
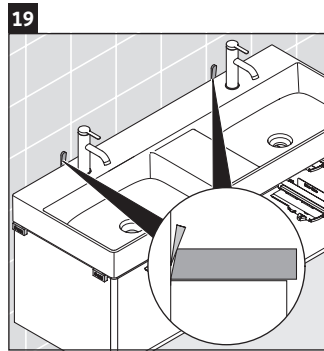
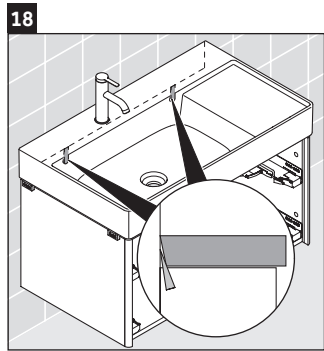
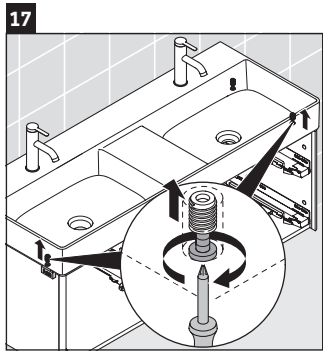
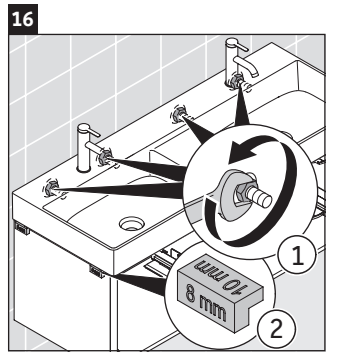
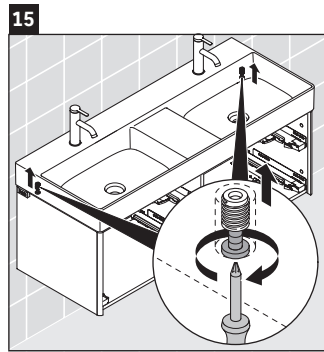
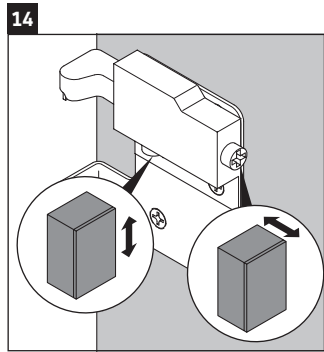
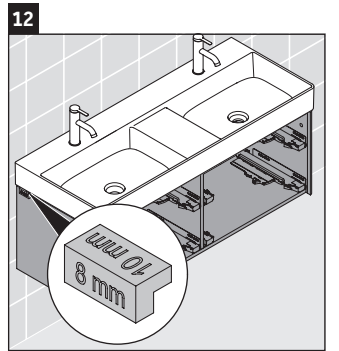
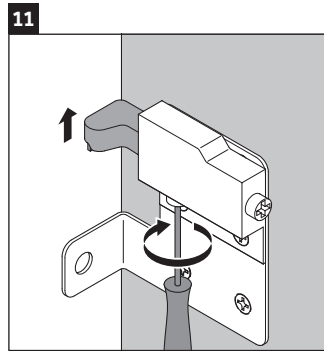
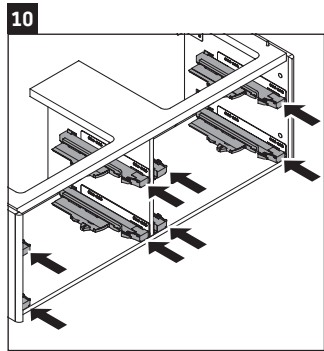
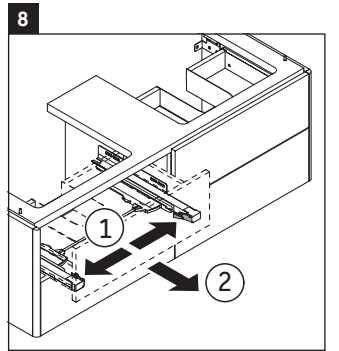
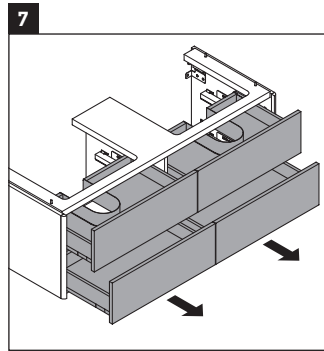
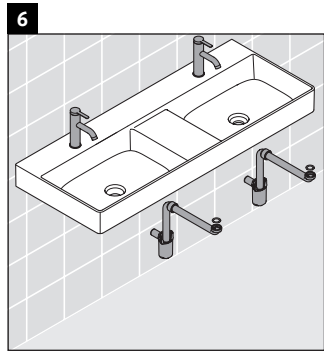
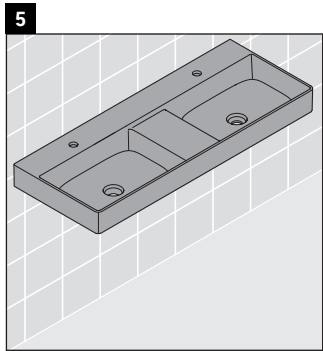
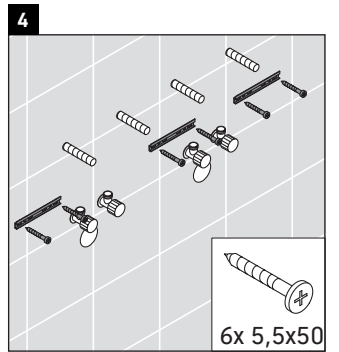
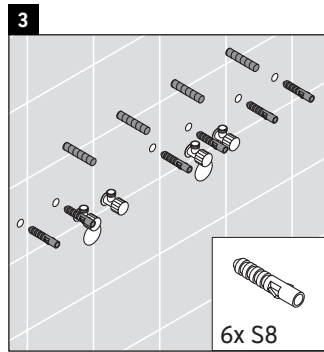
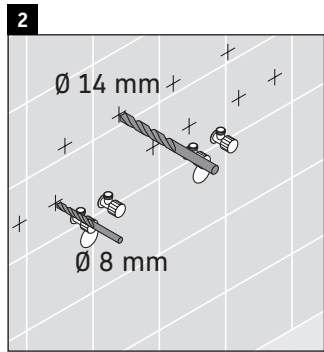
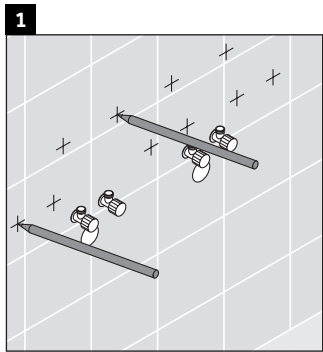

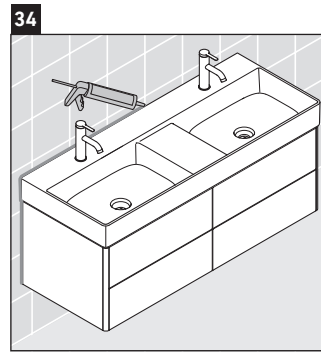
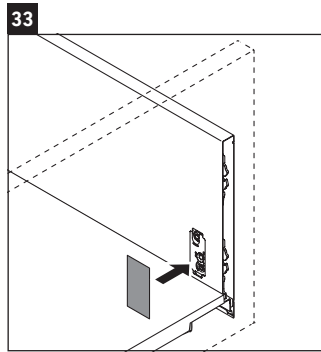
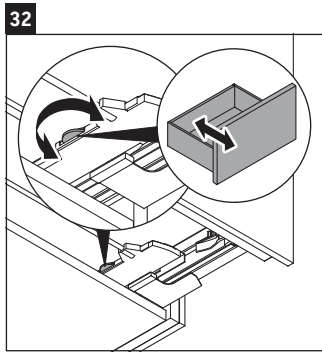
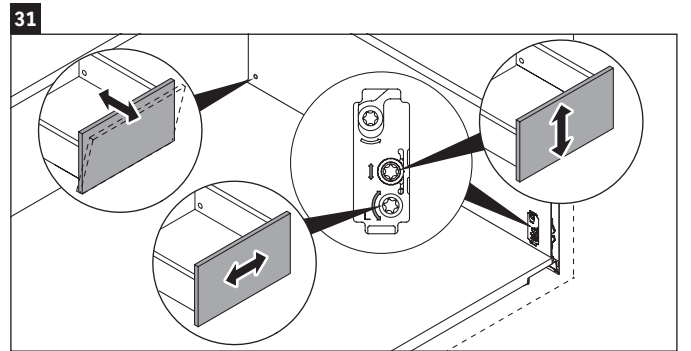
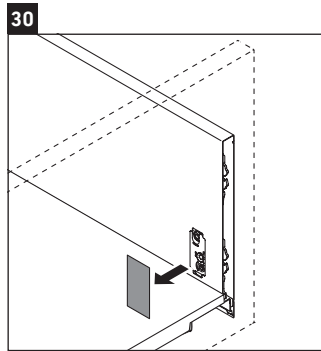
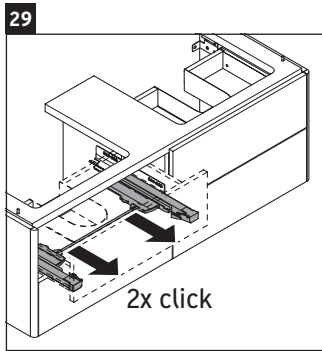
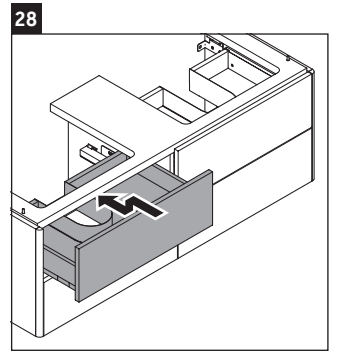
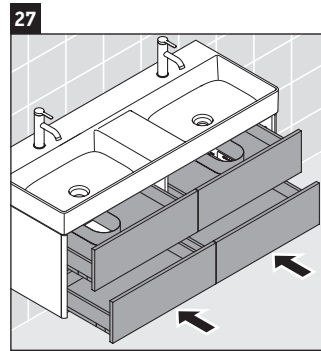
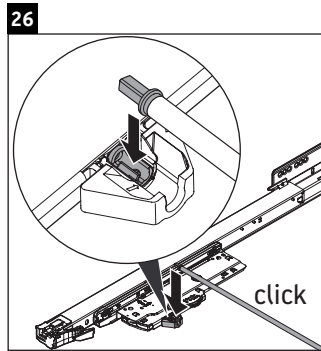
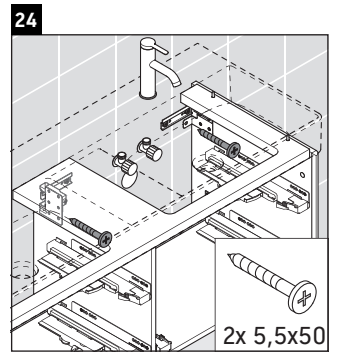
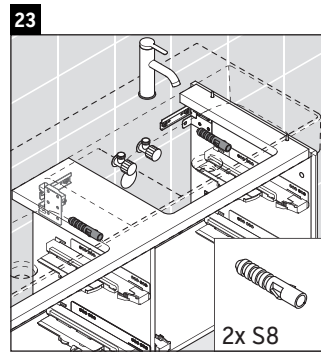
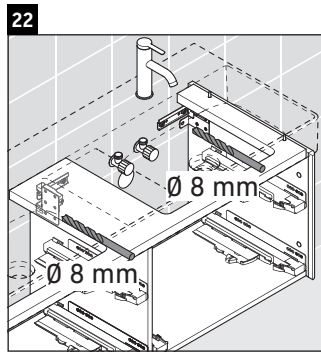
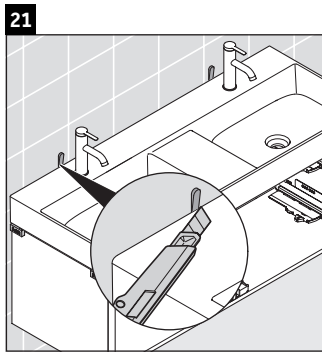

**Duravit AG**  
P.O. Box 240  
Werderstr. 36  
78132 Hornberg  
Germany  
Phone +49 78 33 70 0  
Fax +49 78 33 70 289  
info@duravit.com  
www.duravit.com

