

DE	Montageanleitung	2
FR	Instructions de montage	3
EN	assembly instructions	4
IT	Istruzioni per Installazione	5
ES	Instrucciones de montaje	6
NL	Handleiding	7
DK	Monteringsvejledning	8
PT	Manual de Instalação	9
PL	Instrukcja montażu	10
CS	Montážní návod	11
SK	Montážny návod	12
ZH	组装说明	13
RU	Инструкция по монтажу	14
HU	Szerelési útmutató	15
FI	Asennusohje	16
SV	Monteringsanvisning	17
LT	Montavimo instrukcijos	18
HR	Uputstva za instalaciju	19
TR	Montaj kılavuzu	20
RO	Instrucțiuni de montare	21
EL	Οδηγία συναρμολόγησης	22
SL	Navodila za montažo	23
ET	Paigaldusjuhend	24
LV	Montāžas instrukcija	25
SR	Uputstvo za montažu	26
NO	Montasjeveiledning	27
BG	Ръководство за монтаж	28
SQ	Udhëzime rreth montimit	29
AR	تعليمات التجميع	30

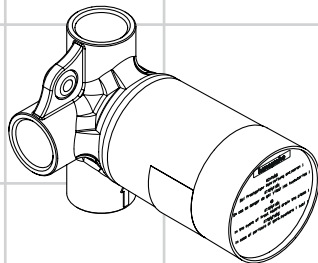

Trio Stop
15981180



Sicherheitshinweise

- ⚠ Bei der Montage müssen zur Vermeidung von Quetsch- und Schnittverletzungen Handschuhe getragen werden.
- ⚠ Große Druckunterschiede zwischen den Kalt- und Warmwasseranschlüssen müssen ausgeglichen werden.

Montagehinweise

- Die Armatur muss nach den gültigen Normen montiert, gespült und geprüft werden.
- Vor der Montage muss das Produkt auf Transportschäden untersucht werden. Nach dem Einbau werden keine Transport- oder Oberflächenschäden anerkannt.
- Die Armatur muss isoliert und schallentkoppelt montiert werden.

Montagebeispiele (siehe Seite 31)

Montage (siehe Seite 32)

1. Eingebaute und geprüfte Trio einputzen, bzw. bei Vorwandinstallation mit Paneel verkleiden. Nach Austrocknen der verputzten Wandoberfläche, die Nahtstelle zwischen Wand und Abdichthülse des Unterputzventils mit Silikon (essigsäurefrei!) ausspritzen.
2. PCI-Lastogum oder einen vergleichbaren Dichtstoff nach Herstellerangaben auf die Wand auftragen.
3. Dichtmanschette über die Abdichthülse stülpen und in den Kleber und Silikon eindrücken.

Achtung! Die Dichtmanschette darf nicht heiß verklebt werden.

Falls die Trio Stop Ab- / Umstellung heißverklebt werden soll, muß darauf geachtet werden, das diese nicht beschädigt wird.

Symbolerklärung



Kein essigsäurehaltiges Silikon verwenden!



Maße (siehe Seite 33)



Serviceteile (siehe Seite 34)

Sonderzubehör



Verlängerung (Artikelnummer 96370000)
nicht im Lieferumfang enthalten



Prüfzeichen (siehe Seite 33)





Endmontage (siehe Seite 35)



Montage siehe Seite 32



Consignes de sécurité

-  Lors du montage, porter des gants de protection pour éviter toute blessure par écrasement ou coupure.
-  Il est conseillé d'équilibrer les pressions de l'eau chaude et froide.

Instructions pour le montage

- La robinetterie doit être installée, rincée et contrôlée conformément aux normes valables.
- Avant son montage, s'assurer que le produit n'a subi aucun dommage pendant le transport. Après le montage, tout dommage de transport ou de surface ne pourra pas être reconnu.
- La robinetterie doit être montée de façon isolée et insonorisée.

Exemples de montage (voir page 31)

Montage (voir page 32)

- Maçonner ou habiller avec des plaques de montage l' Trio déjà montée et testée. Après le séchage de l' enduit de surface, étancher le raccord entre le mur et la douille d'étanchéité du robinet d'arrêt avec un joint de silicone (sans acide acétique!).
- Recouvrir le mur avec du PCI-Lastogum ou un matériel d'étanchéité comparable.
- Enfoncer le joint d'étanchéité autour du boîtier de l'iBox sur le matériel d'étanchéité et sur le joint de silikon.

Attention! La manchette étanche ne doit pas être collée à chaud.

Au cas où l'arrêt / inverseur Trio Stop devrait être collé à chaud, veiller à ne pas l'endommager

Description du symbole



Ne pas utiliser de silicone contenant de l'acide acétique!



Dimensions (voir page 33)



Pièces détachées (voir pages 34)



Accessoires en option

jeu de rallonge (référence 96370000) ne fait pas partie de la fourniture



Classification acoustique et débit (voir page 33)





Finition (voir page 35)



Montage voir page 32



Safety Notes

-  Gloves should be worn during installation to prevent crushing and cutting injuries.
-  The hot and cold supplies must be of equal pressures.

Installation Instructions

- The fitting must be installed, flushed and tested after the valid norms.
- Prior to installation, inspect the product for transport damages. After it has been installed, no transport or surface damage will be honoured.
- The fittings must be mounted in an insulated manner and with sound insulation.

Installation example (see page 31)

Assembly (see page 32)

1. Plaster in the installed Trio, in case of pre-wall installation cover the Trio with a panel.
After the plastered wall surface is dry, seal the gap between wall and plastic sleeve of the flush valve with silicone (free from acetic acid!).
2. Apply PCI-Lastogum or similar sealing compound on the wall in accordance with manufacturers indications.
3. Put gasket over the plastic sleeve of the Quattro four-way-diverter.

Important! The gasket is not suitable for hot glue.

If the Trio Stop should be hot glued, please take care that it is not damaged.

Symbol description



Do not use silicone containing acetic acid!



Dimensions (see page 33)



Spare parts (see page 34)

Special accessories



extension (article number 96370000) order as an extra



Test certificate (see page 33)





Final assembly (see page 35)



Assembly see page 32



Indicazioni sulla sicurezza

-  Durante il montaggio, per evitare ferite da schiacciamento e da taglio bisogna indossare guanti protettivi.
-  **Attenzione!** Compensare le differenze di pressione tra i collegamenti dell'acqua fredda e dell'acqua calda.

Istruzioni per il montaggio

- La rubinetteria deve essere installata, pulita e testata secondo le istruzioni riportate!
- Prima del montaggio è necessario controllare che non ci siano stati danni durante il trasporto. Una volta eseguito il montaggio, non verranno riconosciuti eventuali danni di trasporto o delle superfici.
- Il rubinetto deve essere installato isolato e disaccoppiato dai rumori.

Esempio di installazione (vedi pagg. 31)

Montaggio (vedi pagg. 32)

1. Pulire l' Trio e installato e collaudato ed in caso di installazioni sulla.
 1. Parete coprire con il pannello.
A parete bene asciutta, sigillare con silicone (esente da acido acetico!) il punto di congiunzione tra la parete e la scatola in materiale plastico della valvola sotto intonaco.
2. Applicare sulla parete PCI-Lastogum o un materiale a tenuta ermetica simile in base alle indicazioni fornite dal produttore.
3. Applicare la guarnizione in dotazione al deviatore Quattro.

Attenzione! Il manicotto di tenuta non deve essere incollato a caldo.

Nel caso l'inserto arresto/inversione Trio deve essere incollato caldo, allora bisogna fare attenzione che questi non vengono danneggiati.

Descrizione simbolo



Non utilizzare silicone contenente acido acetico!



Ingombri (vedi pagg. 33)



Parti di ricambio (vedi pagg. 34)



Accessori speciali

prolunga (codice articolo 96370000) non contenuto nel volume di fornitura



Segno di verifica (vedi pagg. 33)



Montaggio finale (vedi pagg. 35)



Montaggio vedi pagg. 32



Indicaciones de seguridad

- ⚠ Durante el montaje deben utilizarse guantes para evitar heridas por aplastamiento o corte.
- ⚠ Grandes diferencias de presión en servicio entre agua fría y agua caliente deben equilibrarse.

Indicaciones para el montaje

- El grifo tiene que ser instalado, probado y testado, según las normas en vigor.
- Antes del montaje se debe examinarse el producto contra daños de transporte. Después de la instalación so se reconoce ningún daño de transporte o de superficie.
- El grifo debe ser instalado con aislamiento y desacoplamiento acústico.

Ejemplos de montaje (ver página 31)

Montaje (ver página 32)

1. Poner silicona en la fuga entre el cuerpo de plástico del Trio y la pared
Una vez seca la superficie mural estucada, inyectar silicona (libre de ácido acético) al área de costura entre el muro y el manguito de estanqueidad de
2. Aplicar en la pared una cola estanqueizadora según las indicaciones del fabricante.
3. Colocar la junta suministrada sobre el cuerpo de plástico del iBox y apretar contra la cola y silicona en la pared.

¡Atención! El manguito de estanqueidad no debe pegarse en caliente.

En caso de que deba pegarse en caliente el dispositivo de apagado/cambio Trio Stop, debe tenerse cuidado de que no resulte dañado.

Descripción de símbolos



No utilizar silicona que contiene ácido acético!



Dimensiones (ver página 33)



Repuestos (ver página 34)



Opcional

Prolongación (artículo número 96370000) no incluido en el suministro



Marca de verificación (ver página 33)



Montaje final (ver página 35)



Montaje ver página 32



Veiligheidsinstructies

- ⚠ Bij de montage moeten ter voorkoming van knel- en snijwonden handschoenen worden gedragen.
- ⚠ Grote drukverschillen tussen de koud- en warmwatertoevoer dienen vermeden te worden.

Montage-instructies

- Leidingen doorspoelen volgens Norm. De mengkraan vervolgens monteren en controleren.
- Vóór de montage moet het product gecontroleerd worden op transportschade. Na de inbouw wordt geen transport- of oppervlakteschade meer aanvaard.
- De armatuur moet geïsoleerd en geluidsontkoppeld gemonteerd worden.

Montagevoorbeelden (zie blz. 31)

Montage (zie blz. 32)

1. De ingebouwde en geteste Trio aansmeren of met voorzetwand systeem ombouwen. Nadat het bezette muuroppervlak uitgedroogd is, moet de naad tussen de muur en de afdichtingshuls van de inbouwstopkraan met silicone (azijnzuurvrij!) dichtgespoten worden.
2. PCI Lastogum of een vergelijkbaar afdichtingsmateriaal (zie voorschriften fabrikant) op de wand aanbrengen.
3. De dichtmanchet over het kunststof huis van de iBox schuiven en in dichtmateriaal en siliconenkit vastdrukken.

Attentie! De dichtmanchet mag niet warm omwikkeld worden.

Als de Trio Stop stop- / omstelkraan heet moet worden gelijmd, moet erop worden gelet dat hij niet beschadigd wordt.

Symboolbeschrijving



Gebruik geen zuurhoudende silicone!



Maten (zie blz. 33)



Service onderdelen (zie blz. 34)



Toebehoren

Verlengstuk (Artikelnummer 96370000) behoort niet tot het leveringspakket



Keurmerk (zie blz. 33)



Afmontage (zie blz. 35)



Montage zie blz. 32



Sikkerhedsanvisninger

- ⚠ Ved monteringen skal der bruges handsker for at undgå kvæstelser og snitsår.
- ⚠ Større trykforskelle mellem koldt og varmt vand bør udjævnes.

Monteringsanvisninger

- Ifølge gældende regler, skal armaturet monteres, skylles igennem og afprøves.
- Før monteringen skal produktet kontrolleres for transportskader. Efter monteringen godkendes transportskader eller skader på overfladen ikke længere.
- Armaturet skal monteres isoleret og lydisoleret.

Monteringseksempler (se s. 31)

Montering (se s. 32)

1. Der pudses op omkring den indbyggede og afprøvede Trio; ved installation foran væggen sættes paneler op.
Når væggen er tør, fuges der med silikone (eddikesyre-fri) rundt om den skjulte ventil's kappe.
2. Påfør væggen vådrumsmembran eller en lignende klæbemasse.
3. Tætningsmanchetten trækkes over iBoxens kunststofkappe og trykkes fast i klæbemassen.

Advarsel! Der må ikke bruges smeltelim til tætningsmanchetten.

Hvis Trio Stop afbryderen / omskifteren skal smeltelimes, skal der holdes øje med at den ikke beskadiges.

Symbolbeskrivelse



Der må ikke benyttes eddikesyreholdig silikone!



Målene (se s. 33)



Reservedele (se s. 34)

Specialtilbehør



Forlængersæt (Artikelnummer 96370000) ikke med i leveringsomfang



Godkendelse (se s. 33)



Slutmontering (se s. 35)



Montering se s. 32



Avisos de segurança

- ⚠ Durante a montagem devem ser utilizadas luvas de protecção, de modo a evitar ferimentos resultantes de entalamentos e de cortes.
- ⚠ Grandes diferenças entre as pressões das águas quente e fria devem ser compensadas.

Avisos de montagem

- A misturadora deve ser instalada, purgada e testada de acordo com as normas em vigor.
- Antes da montagem deve-se controlar o produto relativamente a danos de transporte. Após a montagem não são aceites quaisquer danos de transporte ou de superfície.
- A torneira deve ser montada de forma isolada e desacoplada sonoramente.

Exemplos de montagem (ver página 31)

Montagem (ver página 32)

1. Limpar a parede à volta da Trio instalada e testada,
 1. no caso de ser embutida cobrir a Trio com um painel.
Após secagem da superfície da parede areada, deve-se encher a junta entre a parede e o casquilho de vedação da válvula com silicone (sem ácido acético!).
 2. Aplicar PCI-Lastogum ou um composto vedante similar na parede de acordo com as indicações do fabricante.
 3. Colocar o disco de borracha sobre a cápsula plástica do inversor e pressionar contra a cola e a silicone.

Atenção! A junta de vedação não pode ser colada a quente.

Se pretender efectuar uma colagem quente da adaptação Trio Stop, é necessário ter em atenção que esta não seja danificada.

Descrição do símbolo



Não utilizar silicone que contenha ácido acético!



Medidas (ver página 33)



Peças de substituição (ver página 34)



Acessórios especiais

Crescente (referência 96370000) não incluído no volume de fornecimento



Marca de controlo (ver página 33)



Acabamento Fina (ver página 35)



Montagem ver página 32



Wskazówki bezpieczeństwa

- ⚠ Aby uniknąć zranień, takich jak zgniecenia czy przecięcia, podczas montażu należy nosić rękawice.
- ⚠ Znaczne różnice ciśnień na dopływach ciepłej i zimnej wody muszą zostać wyrównane.

Wskazówki montażowe

- Armatura musi być zamontowana, przepłukana i wypróbowana według obowiązujących norm.
- Przed montażem należy skontrolować produkt pod kątem szkód transportowych. Po montażu nie widać żadnych szkód transportowych ani szkód na powierzchni.
- Armaturę należy zaizolować i zamontować z izolacją dźwiękową.

Przykłady montażowe (patrz strona 31)

Montaż (patrz strona 32)

1. Zatynkować wbudowany i sprawdzony Trio wzgl. w przypadku instalacji naściennej, zamontować panel osłaniający.
Po wyschnięciu otynkowanej powierzchni ściany, uszczelnić powierzchnię złącza między ścianą a tuleją uszczelniającą zaworu podtynkowego silikonem (bez kwasu octowego!).
2. Nałożyć na ścianę środek uszczelniający lub klej do płytek.
3. Pierścień uszczelniający nałożyć na wystający korpus i przymocować za pomocą kleju i silikonu.

Uwaga! Kołnierz uszczelniający nie może być przyklejany na gorąco.

Jeżeli wyłącznik / przełącznik Trio Stop ma być zaklejony na gorąco, należy zwrócić uwagę na to, by nie uszkodzić sprzętu.

Opis symbolu



Nie stosować silikonów zawierających kwas octowy!



Wymiary (patrz strona 33)



Części serwisowe (patrz strona 34)

Wyposażenie specjalne



Przedłużka (nr art. 96370000) Nie jest częścią dostawy



Znak jakości (patrz strona 33)





Montaż końcowy (patrz strona 35)



Montaż patrz strona 32



Bezpečnostní pokyny

-  Pro zabránění řezným zraněním a pohmožděnímám je nutné při montáži nosit rukavice.
-  Je nutné vyrovnat velké rozdíly tlaku mezi přípoji studené a teplé vody.

Pokyny k montáži

- Armatura se musí montovat, proplachovat a testovat podle platných norem.
- Před montáží je třeba produkt zkontrolovat, zda nebyl při transportu poškozen. Po zabudování nebudou uznány žádné škody způsobené transportem nebo poškození povrchu.
- Při instalaci musí být provedena tak, aby byla baterie zaizolovaná a zvukotěsná.

Příklady montáže (viz strana 31)

Montáž (viz strana 32)

1. Zabudovaný a vyzkoušený Trio začistit, příp. u instalace před stěnu obložit panelem. Po oschnutí omítnuté zdi vyplňte místo švu mezi zdí a těsnícím pouzdrem podomítkového ventilu silikonem (bez obsahu kyseliny octové).
2. Na stěnu nanést PCI-Lastogum nebo nějakou srovnatelnou těsnící hmotu podle pokynů výrobce.
3. Těsnící manžetu překlopte přes utěšňovací kryt a vtačte do lepidla a silikonu.

Pozor! Těsnící manžeta nesmí být slepená za horka.

Jestliže je potřeba přechod Trio Stop přilepit za tepla, je třeba dbát toho, aby se nepoškodil.

Popis symbolů



Nepoužívat silikon s obsahem kyseliny octové!



Rozměry (viz strana 33)



Servisní díly (viz strana 34)



Zvláštní příslušenství

prodloužení (kat.č. 96370000) není součástí dodávky



Zkušební značka (viz strana 33)



Konečná montáž (viz strana 35)



Montáž viz strana 32



Bezpečnostné pokyny

- ⚠ Pri montáži musíte nosiť rukavice, aby ste predišli pomliaždeninám a rezným poraneniam.
- ⚠ Veľké rozdiely v tlaku medzi prípojkami studenej a teplej vody musia byť vyrovnané.

Pokyny pre montáž

- Armatúra sa musí montovať, preplachovať a testovať podľa platných noriem.
- Pred montážou musíte produkt skontrolovať, či nebol počas transportu poškodený. Po zabudovaní nebudú uznané žiadne škody spôsobené transportom alebo poškodenia povrchu.
- Armatúra sa musí namontovať zaizolovaná a s oddelením od hluku v pevných telesách.

Príklady montáže (viď strana 31)

Montáž (viď strana 32)

1. 0
Po uschnutí omietnutej steny vyplňte miesto švu medzi stenou a tesniacim puzdrom podomietkového ventilu silikónom (bez obsahu kyseliny octovej).
2. Na stenu naniesť PCI-Lastogum, alebo porovnateľný tesniaci materiál podľa pokynov výrobcu.
3. Tesniacu manžetu preklopte cez utesňovací kryt a vložte do lepidla a silikónu.

Pozor! Tesniaca manžeta nesmie byť lepená za horúca.

Ak je potrebné prechod Trio Stop prilepiť za tepla, treba dbať na to, aby sa nepoškodil.

Popis symbolov



Nepoužívať silikón s obsahom kyseliny octovej!



Rozmery (viď strana 33)



Servisné diely (viď strana 34)



Predĺženie (výrobné číslo 96370000) nie je súčasťou dodávky



Osvedčenie o skúške (viď strana 33)



Konečná montáž (viď strana 35)



Montáž viď strana 32



⚠️ 安全技巧

△ 装配时为避免挤压和切割受伤，必须戴上手套。

△ 冷热水管间过大的压力差必须予以平衡。

安装提示

- 必须按照现行的规定安装，冲洗和测试产品。
- 安装前必须检查产品是否受到运输损害。安装后将不认可运输损害或表面损伤。
- 龙头必须以静噪的方式独立安装。

安装示意 (参见第 31 页)

安装 (参见第 32 页)

1. 安装的Trio中有水泥，如果是预先在墙壁上安装，使用板子覆盖Trio。
在抹灰墙面干燥后，墙体与暗装阀门密封套之间的接缝用硅胶（不含醋酸！）填平。
2. 遵照制造商的说明，在边壁上使用PCI胶黏层或类似的密封材料。
3. 密封涨圈罩到密封套上并压入到胶水和硅胶中。

注意！不能热粘贴密封涂层。

如果三档关闭/转换装置需要热粘接，则必须注意不使之受损。

符号说明



请勿使用含有乙酸的硅！



大小 (参见第 33 页)



备用零件 (参见第 34 页)

选装附件



加长件 (商品编号 96370000) 不在供货范围内



检验标记 (参见第 33 页)



总装配 (参见第 35 页)



安装 参见第 32 页



Указания по технике безопасности

- ⚠ Во время монтажа следует надеть перчатки во избежание прищемления и порезов.
- ⚠ донного клапа. Перед установкой смесителя необходимо регулировочными кранами выровнять давление холодной и горячей воды при помощи вентилей регулирующих подачу воды в квартиру.

Указания по монтажу

- Смеситель должен быть смонтирован по действующим нормам и в соответствии с настоящей инструкцией, проверен на герметичность и безупречность работы.
- Перед монтажом следует проверить изделие на предмет повреждений при перевозке. После монтажа претензии о возмещении ущерба за повреждения при перевозке или повреждения поверхностей не принимаются.
- Арматура должна монтироваться изолированно и со звуковой защитой.

варианты установки (см. стр. 31)

Монтаж (см. стр. 32)

1. Замуруйте установленный и проверенный Trio , или при настенной установке закройте панелью. После высыхания штукатурки на поверхности стены нанесите силиконовое покрытие (не содержащее уксусную кислоту!) на стык стены и уплотнительной втулки скрытого клапана.
2. Нанесите на стену PCI-Lastogum или подобный герметик, указанный изготовителем.
3. Накройте уплотнительной манжетой уплотнительную втулку и вдавите в клей и силиконовое покрытие.

ВНИМАНИЕ! Уплотнительную манжету не разрешается приклеивать горячим способом.

При склеивании в горячем состоянии не допускайте повреждения трехходового сигнального выключателя/переключателя Trio.

Описание символов



Не применяйте силикон, содержащий уксусную кислоту.



Размеры (см. стр. 33)



Комплект (см. стр. 34)

Специальные принадлежности



Удлинение (арт. № 96370000) не включено в объем поставки!



Знак технического контроля (см. стр. 33)



Окончательная сборка (см. стр. 35)



Монтаж см. стр. 32



Biztonsági utasítások

- ⚠ A szerelésnél a zúzódások és vágási sérülések elkerülése érdekében kesztyűt kell viselni.
- ⚠ A hidegvíz- és a melegvíz-csatlakozások közötti nagy nyomáskülönbséget kikell egyenlíteni!

Szerelési utasítások

- A csaptelepet az érvényben lévő előírásoknak megfelelően kell felszerelni, átöblíteni és ellenőrizni.
- A szerelés előtt ellenőrizni kell, hogy a terméknek nincs-e szállítási sérülése. Beépítés után a szállítási- vagy felületi sérüléseket nem ismerik el.
- A csaptelepet szigetelve és zajszigetelve kell felszerelni.

Szerelési példák (lásd a 31. oldalon)

Szerelés (lásd a 32. oldalon)

1. A beépített és ellenőrzött Trio t vakoljuk be, illetve könnyűszerkezetes falrendszereknél gipszkartonnal burkoljuk.
A bevakolt falfelület száradása után, a fal és az alapvakolat szelepének záróhélyve közötti helyet szilikonnal (ecetsavtól mentes!) tömíteni kell.
2. Hordjuk fel a falra a PCI-Lastogum-ot vagy a hasonló szigetelőanyagot a gyártó előírásainak megfelelően.
3. A tömítőgallért hajtsa a tömítőhélyve, és nyomja bele a ragasztóba és a szilikonba.

Figyelem! A szigetelő gumigyűrűt nem szabad forrón felragasztani.

Ha a Trio Stop leállító / váltószelepet forrón kell ragasztani, akkor ügyelni kell arra, hogy ne rongálódjon meg.

Szimbólumok leírása



Ne használjon ecetsavtartalmú szilikont!



Méretet (lásd a 33. oldalon)



Tartozékok (lásd a 34. oldalon)



Egyéb tartozék

Hosszabbítás (cikkszám 96370000) a szállítási egység nem tartalmazza



Vizsgajel (lásd a 33. oldalon)



Beépített, kész szerelvény (lásd a 35. oldalon)



Szerelés lásd a 32. oldalon



Turvallisuusohjeet

- △ Asennuksessa on käytettävä käsineitä puristumien ja viiltojen aiheuttamien tapaturmien estämiseksi.
- △ Suuret paine-erot kylmä- ja kuumavesiliitäntöjen välillä on tasattava.

Asennusohjeet

- Kaluste on asennettava, huuhdeltava ja tarkastettava voimassa olevien määräysten mukaisesti.
- Ennen asennusta on tarkastettava tuotteen mahdolliset kuljetusvahingot. Asennuksen jälkeen kuljetus- ja pintavaurioita ei hyväksytä.
- Hana on asennettava eristettynä ja äänenvaimennettuna.

Asennusesimerkkejä (katso sivu 31)

Asennus (katso sivu 32)

1. Muuraa paikoilleen asennettu ja tarkastettu Trio seinän sisään tai verhoile pinta-asennettu Trio paneelilla. Kun rapattu seinäpinta on kuivunut, seinän ja rappauksen alla olevan venttiilin tiivisteholkin väliin ruiskutetaan silikonია (etikahapotonta).
2. Levitä seinään PCI-Lastogum:ia tai vastaavaa tiivisteametia valmistajan ohjeiden mukaisesti.
3. Aseta tiivistekaulus tiivisteholkin päälle ja paina kaulus liiman ja silikonin sisään.

Huomio! Tiivistekaulusta ei saa kuumaliimata.

Jos Trio Stop suljin/vaihdin halutaan kuumaliimata, on varottava, että se ei vahingoitu.

Merkin kuvaus



Älä käytä etikahappopitoista silikonია!



Mitat (katso sivu 33)



Varaosat (katso sivu 34)

Erityisvaruste



Pidennys (tuotenumero 96370000) ei kuulu toimitukseen



Koestusmerkki (katso sivu 33)





Loppuasennus (katso sivu 35)



Asennus katso sivu 32



Säkerhetsanvisningar

-  Handskar ska bäras under monteringsarbetet så att man kan undvika kläm- och skärskadorgen werden.
-  Stora tryckskillnader mellan anslutningarna för varmt och kallt vatten måste utjämnas.

Monteringsanvisningar

- Armaturen måste installeras, genomspolas och testas enligt gällande föreskrifter.
- Det måste undersökas om produkten har transportskador innan den monteras. Efter monteringen accepteras inga transport- eller ytskiktsskador.
- Blandaren måste monteras isolerat och ljudabsorberande.

Monteringsexempel (se sidan 31)

Montering (se sidan 32)

1. Anslutningen måste passa för flänspackning
När den putsade väggytan har torkat tätas skarven mellan väggen och tätningshylsan till den infällda ventilen med silikon (fri från ättiksyra) som sprutas på.
2. Lagg på PCI-Lastogum, eller ett jämförbart tätningsmaterial, på väggen enligt tillverkarens anvisningar.
3. Trä en tätningsmanschett över tätningshylsan och tryck in den i limmet och silikonet.

OBS! Tätningsmanschetten får inte varmlimmas.

Om Trio Stop avstängningen/omkopp-lingen ska varmlimmas är det viktigt att enheten inte skadas.

Symbolförklaring



Använd inte silikon som innehåller ättiksyra!



Måtten (se sidan 33)



Reservdelar (se sidan 34)

Specialtillbehör



Förlängning (artikelnummer 96370000)
medföljer ej leveransen



Testsigill (se sidan 33)





Slutmontering (se sidan 35)



Montering se sidan 32



Saugumo technikos nurodymai

-  Apsaugai nuo užspaudimo ir įsijovimo montavimo metu mūvėkite pirštines.
-  Turi būti išlyginti šalto ir karšto slėgio nelygumai.

Montavimo instrukcija

- Maišytuvas privalo būti montuojamas ir išbandomas pagal veikiančias normas ir šią instrukciją.
- Prieš montuojant būtina patikrinti, ar gaminys nebuvo pažeistas transportavimo metu. Sumontavus pretenzijos dėl transportavimo ir paviršiaus pažeidimų nepriimamos.
- Maišytuvas turi būti sumontuotas izoliuotai ir naudojant garso izoliaciją.

Montavimo pavyzdžiai (žr. psl. 31)

Montavimas (žr. psl. 32)

- Prijungimas turi atitikti plokščiąjį sandariklį. Kai nutinkuota siena išdžiūva, silikonu (be acto rūgšties!) išpurkškite siūlę tarp sienos ir potinkinio vožtuvo.
- Vadovaudamiesi gamintojo nurodymais, užtepkite ant sienos PCI Lastogum ar panašią sandarinamąją priemonę.
- Ant sandarinimo įvorės užmaukite sandarinimo manžetus ir įspauskite į klijus ir silikoną.

Dėmesio! Sandariklio neklijuokite karštuoju būdu.

Jeigu TRIO STOP išjungiklis ar perjungiklis turi būti klijuojamas karštu būdu, tada dirbkite atsargiai, kad jo nesugadintumėte.

Simbolio aprašymas



Nenaudokite silikono, kurio sudėtyje yra acto rūgšties!



Išmatavimai (žr. psl. 33)



Atsarginės dalys (žr. psl. 34)



Specialūs priedai

Ilgiklis (Art.Nr. 96370000) nėra pridedama



Bandymo pažyma (žr. psl. 33)





Galutinis montavimas (žr. psl. 35)



Montavimas žr. psl. 32



Sigurnosne upute

-  Prilikom montaže se radi sprječavanja prignječenja i posjekotina moraju nositi rukavice.
-  Velika razlika u pritisku između vruće i hladne vode mora biti izbalansirana.

Upute za montažu

- Cijevi moraju biti postavljene, isprane i testirane prema važećim normama.
- Prije montaže mora se provjeriti je li proizvod oštećen prilikom transporta. Nakon ugradnje se ne priznaju nikakve reklamacije koje se odnose na površinska i transportna oštećenja.
- Montirana armatura mora biti izolirana i zvučno odvojena.

Primjeri instalacija (pogledaj stranicu 31)

Sastavljanje (pogledaj stranicu 32)

1. Ugrađen i provjeren Trio ožbukajte univerzalnom žbukom, tj. kod predzidnih instalacija obložite panelom.
Nakon sušenja ožbukanog zida poprskajte spoj između zida i brtveće čahure uzidnog ventila silikonom (koji ne sadrži octenu kiselinu).
2. Nanesite na zid PCI-Lastogum ili neki slični brtveni materijal sukladno navodima proizvođača.
3. Brtvene manžete postavite preko čahure i utisnite u lijepak i silikon.

Pažnja! Manžetu za brtvljenje ne smijete lijepiti vrućim ljepljivom.

Ako Trio za zaustavljanje, zatvaranje i preusmjeravanje mora biti vruće prelijepljen, mora se paziti da se ne ošteti.

Opis simbola



Nemojte koristiti silikon koji sadrži octenu kiselinu!



Mjere (pogledaj stranicu 33)



Rezervni dijelovi (pogledaj stranicu 34)

Posebni pribor



Produljenje (br. Proizvoda 96370000) Nije sadržano u isporuci!



Oznaka testiranja (pogledaj stranicu 33)



Završna montaža (pogledaj stranicu 35)



Sastavljanje pogledaj stranicu 32



Güvenlik uyarıları

- ⚠ Montaj esnasında ezilme ve kesilme gibi yaralanmaları önlemek için eldiven kullanılmalıdır.
- ⚠ Sıcak ve soğuk su bağlantıları arasında büyük basınç farklılıkları varsa, bu basınç farklılıklarının dengelenmesi gerekir.

Montaj açıklamaları

- Batarya monte edilmeli, geçerli normlardan sonra akis testi yapılmalıdır.
- Montaj işleminden önce ürün nakliye hasarları yönünden kontrol edilmelidir. Montaj işleminden sonra nakliye veya yüzey hasarları için sorumluluk üstlenilmemektedir.
- Armatür izoleli ve ses ayırmalı olarak monte edilmelidir.

Montaj Örneği (Bakınız sayfa 31)

Montajı (Bakınız sayfa 32)

1. Bağlantı yassı conta için uygun olmalıdır. Duvar yüzeyinin sıvası kuruduktan sonra sıva altı ventilin duvar ile yalıtım kovani arasına silikon (asetiksiz!) püskürtün.
2. PCI-Lastıgım ya da üretici bilgilerine göre benzer bir izolasyon maddesini duvara uygulayın.
3. Conta manşetini yalıtım kovani üzerine geçirin ve yapıştırıcı ile silikonu içine bastırın.

Önemli! Körük sıcak tutkalanmamalıdır.

Eğer Trio Stop kapatıcı / uyarlayıcı sıcak olarak yapıştırılacaksa, bunun hasar görmemesine dikkat edilmelidir.

Simge açıklaması



Asetik asit içeren silikon kullanmayın!



Ölçüleri (Bakınız sayfa 33)



Yedek Parçalar (Bakınız sayfa 34)



Özel aksesuarlar

Uzatma (Ürün kodu 96370000) Teslimat kapsamına dahil değildir



Kontrol işareti (Bakınız sayfa 33)





Son Uygulama (Bakınız sayfa 35)



Montajı Bakınız sayfa 32



Instrucțiuni de siguranță

-  La montare utilizați mănuși pentru evitarea contuziunilor și tăierii mâinilor.
-  Diferențele de presiune mari între alimentarea cu apă rece și apă caldă trebuie echilibrate.

Instrucțiuni de montare

- Bateria trebuie montată, clătită și verificată conform normelor în vigoare.
- Înainte de instalare verificați, dacă produsul prezintă deteriorări de transport. După instalare garanția nu acoperă deteriorările de transport și cele de suprafață.
- Armătura trebuie montată cu izolație termică și fonică.

Exemple de montare (vezi pag. 31)

Montare (vezi pag. 32)

1. Racordul trebuie să fie potrivit pentru fitilul plat. După uscarea suprafeței de perete tencuit, umpleți cu silicon (fără conținut de acid acetic!) cavitatea dintre perete și tubul de etanșare a ventilului pentru tencuire.
2. Se aplică pe perete PCI-Lastogum sau un alt material de etanșare, în conformitate cu indicațiile fabricantului.
3. Aplicați manșeta de etanșare peste tubul de etanșare și presați-o în adeziv și silicon.

Atenție! Manșeta de etanșare nu trebuie lipită la cald.

În cazul în care întrerupătorul/comutatorul cu trei căi Trio trebuie lipit la cald, aveți grijă să nu-l deteriorați.

Descrierea simbolurilor



Nu utilizați silicon cu conținut de acid acetic!



Dimensiuni (vezi pag. 33)



Piese de schimb (vezi pag. 34)



Accesorii opționale

Prelungitor (Nr. produs 96370000) nu este inclus în setul livrat



Certificat de testare (vezi pag. 33)





Montare finală (vezi pag. 35)



Montare vezi pag. 32



Υποδείξεις ασφαλείας

-  Για να αποφύγετε τραυματισμούς κατά τη συναρμολόγηση πρέπει να φοράτε γάντια.
-  Οι διαφορές της πίεσης μεταξύ της σύνδεσης κρύου και ζεστού νερού θα πρέπει να αντισταθμίζονται.

Οδηγίες συναρμολόγησης

- Η μπαταρία πρέπει να τοποθετηθεί, να πλυθεί και να ελεγχθεί με βάση τους ισχύοντες κανόνες υδραυλικής τέχνης
- Πριν τη συναρμολόγηση πρέπει να εξεταστεί το προϊόν για ζημιές μεταφοράς. Μετά την εγκατάσταση δεν αναγνωρίζονται ζημιές από τη μεταφορά ή επιφανειακές ζημιές.
- Η μπαταρία πρέπει να τοποθετείται με κατάλληλη διάταξη ηχομόνωσης.

Παραδείγματα συναρμολόγησης (βλ. σελίδα 31)

Συναρμολόγηση (βλ. σελίδα 32)

1. Καθαρίστε το ενσωματωμένο και ελεγμένο σύστημα Trio, ή/και ντύστε το με ένα πλαίσιο κατά την επίτοιχη εγκατάσταση.
Αφού στεγνώσει η επιχρισμένη επιφάνεια τοίχου, σφραγίστε τον αρμό μεταξύ τοίχου και δακτυλίου στεγανοποίησης της εντοιχισμένης βαλβίδας με σιλικόνη (χωρίς οξικό οξύ!).
2. Κάνετε χρήση PCI-Lastoform ή κάποιου άλλου αντίστοιχου στεγανοποιητικού υλικού για τον τοίχο σύμφωνα με τις οδηγίες του κατασκευαστή.
3. Περάστε το κολάρο στεγανοποίησης στον δακτύλιο στεγανοποίησης και πιέστε το μέσα στην κόλλα και τη σιλικόνη.

Προσοχή! Η περιμετρική στεγανοποίηση δεν πρέπει να κολληθεί εν θερμώ

Εάν πρέπει να γίνει θερμή συγκόλληση της μετατροπής Trio Stop, πρέπει να δοθεί προσοχή ώστε να μην προκληθεί ζημιά.

Περιγραφή συμβόλων



Μην χρησιμοποιείτε σιλικόνη που περιέχει οξικό οξύ!



Διαστάσεις (βλ. σελίδα 33)



Ανταλλακτικά (βλ. σελίδα 34)

Ειδικά αξεσουάρ



Σωλήνας επιμήκυνσης (αρ. είδους 96370000) δεν περιλαμβάνεται στον παραδοτέο εξοπλισμό



Σήμα ελέγχου (βλ. σελίδα 33)





Τελική συναρμολόγηση (βλ. σελίδα 35)



Συναρμολόγηση βλ. σελίδα 32



Varnostna opozorila

-  Pri montaži je treba nositi rokavice, da se preprečijo poškodbe zaradi zmečkanja ali urezov.
-  Il est conseillé d'équilibrer les pressions de l'eau chaude et froide.

Navodila za montažo

- Armaturo je potrebno montirati, splakniti in testirati v skladu z veljavnimi predpisi.
- Pred montažo je treba izdelek preveriti glede morebitnih transportnih poškodb. Po vgradnji transportne ali površinske poškodbe ne bodo več priznane.
- Armaturo morate montirati izolirano in zvočno neprepustno.

Primeri montaže (glejte stran 31)

Montaža (glejte stran 32)

1. Vgrajene in testirane Trio ometajte oz. v primeru montaže pred steno oblecite s panelom. Ko se omet na površini stene posuši, s silikonom (brez očetne kisline) zatesnite stičišče stene in podometnega ventila.
2. Na steno po navodilih proizvajalca nanesite PCI-Lastogum ali primerljivo tesnilno maso.
3. Na tesnilni tulec natakните tesnilno manšeto in jo pritisnite v lepilo in silikon.

Pozor! Tesnilna manšeta se ne sme zlepiti z vročim lepilom.

V kolikor se mora izklopno/preklopni ventil Trio Stop termo lepiti, je treba poskrbeti, da se pri tem ne poškoduje.

Opis simbola



Ne smete uporabiti silikona, ki vsebuje očetno kislino!



Mere (glejte stran 33)



Rezervni deli (glejte stran 34)



Poseben pribor

Podaljšek (številka artikla 96370000) Ni vključeno



Preskusni znak (glejte stran 33)



Končna montaža (glejte stran 35)



Montaža Glejte stran 32.



Ohutusjuhised

- ⚠ Kandke paigaldamisel muljumis- ja löikevigastuste vältimiseks kindaid.
- ⚠ Kui külma ja kuumu vee ühenduste surve on väga erinev, tuleb need tasakaalustada.

Paigaldamisjuhised

- Seadmestiku paigaldamine, läbipesu ja kontrollimine peab toimuma vastavalt kehtivatele normidele.
- Enne paigaldamist tuleb toodet kontrollida transpordikahjustuste osas. Pärast paigaldamist ei tunnustata enam transpordi- või pinnakahjustuste kaebuseid.
- Armatuur tuleb paigaldada isoleeritult ja helikindlalt.

Paigalduse näited (vt lk 31)

Paigaldamine (vt lk 32)

1. Ühendus peab sobima lametihendi jaoks. Pärast krohvitud seinapinna kuivamist laske seina ja krohvaluse ventiili tihendi ühenduspinnale silikooni (äädikhappevaba!).
2. Kandke seinale PCI-Lastogum'i või mõnda võrdväärset tihendusainet vastavalt tootja andmetele.
3. Pange tihendile tihendusmansett ning suruge liimi ja silikooni sisse.

Tähelepanu! Tihendusmuhvi ei tohi kuumliimida.

Kui Trio Stop regulaator tuleb kuumliimiga paigaldada, tuleb silmas pidada, et see ei kahjustuks.

Sümbolite kirjeldus



Ärge kasutage äädikhapet sisaldavat silikooni!



Mõõtude (vt lk 33)



Varuosad (vt lk 34)



Spetsiaalne lisavarustus

Pikendus (artikli number 96370000) ei sisaldu komplektis



Kontrollsertifikaat (vt lk 33)



Lõplik paigaldus (vt lk 35)



Paigaldamine vt lk 32



Drošības norādes

- ⚠ Montāžas laikā, lai izvairītos no saspiedumiem un iegriezumiem, nepieciešams nēsāt cimdus.
- ⚠ Jāizlīdzina spiediena atšķirības starp aukstā un karstā ūdens pievadiem.

Norādījumi montāžai

- Jaucējkrāns jāmontē, jāskalo un jāpārbauda atbilstoši spēkā esošajām normām.
- Pirms montāžas nepieciešams pārbaudīt, vai produktam transportēšanas laikā nav radušies bojājumi. Pēc iebūvēšanas bojājumi, kas radušies transportēšanas laikā, vai virsmas bojājumi netiek atzīti.
- Armatūra montējama izolēti un ar skaņas izolāciju.

Montāžas piemēri (skat. 31. lpp.)

Montāža (skat. 32. lpp.)

1. Pieslēgumam ir jābūt piemērotam plakanajam blīvējumam
Pēc apmetās sienas virsmas nožūšanas salaidumu starp sienu un zemapmetuma vārsta blīvpatronu piepildiet ar silikonu (bez etiķskābes!).
2. Atbilstoši ražotāja norādījumiem uzklājiet uz sienas PCI-Lastogum vai līdzīgu hermētīki.
3. Blīvējuma manšetes pārlieciet pār blīvējuma apvalku un iespiediet līmē un silikonā.

Uzmanību! Blīvēšanas manšeti nedrīkst salīmēt ar karstu līmi.

Ja Trio Stop apturētājs/pārslēdzējs ir jālīmē ar karsto paņēmienu, jāuzmanās, lai nerastos bojājumi.

Simbolu nozīme



Neizmantojot silikonu, kas satur etiķskābi!



Izmērus (skat. 33. lpp.)



Rezerves daļas (skat. 34. lpp.)



Speciāli aksesuāri

Pagarinājums (artikula numurs 96370000) komplektā netiek piegādāts



Pārbaudes zīme (skat. 33. lpp.)



Beigu montāža (skat. 35. lpp.)



Montāža skat. 32. lpp.



Sigurnosne napomene

- ⚠ Prilikom montaže se radi sprečavanja prignječenja i posekotina moraju nositi rukavice.
- ⚠ Velika razlika u pritisku između vruće i hladne vode mora biti izbalansirana.

Instrukcije za montažu

- Armatura mora biti postavljena, isprana i testirana prema važećim normama.
- Pre montaže se mora proveriti da li je proizvod oštećen pri transportu. Nakon ugradnje se ne priznaju nikakve reklamacije koje se odnose na površinska i transportna oštećenja.
- Armatura se mora montirati tako da bude izolovana i zvučno odvojena.

Primeri montaže (vidi stranu 31)

Montaža (vidi stranu 32)

1. Priključak mora biti prikladan za pljosnату zaptivku. Nakon sušenja omalterisnog zida potrebno je da se spoj između zida i zaptivne čaure uzidnog ventila poprska silikonom (koji ne sadrži sirćetnu kiselinu).
2. Nanesite na zid PCI-Lastogum ili neki slični zaptivni materijal u skladu sa navodima proizvođača.
3. Zaptivne manžetne postavite preko čaure i utisnite u lepak i silikon.

Pažnja! Zaptivna manžetna ne sme da se lepi vrućim lepkom.

Ako Trio za zaustavljanje, zatvaranje i preusmeravanje mora biti vruće prelepljen, mora se paziti da se ne ošteti.

Opis simbola



Nemojte koristiti silikon koji sadrži sirćetnu kiselinu!



Mere (vidi stranu 33)



Rezervni delovi (vidi stranu 34)



Poseban pribor

Produžetak (br. Proizvoda 96370000) Nije sadržano u isporuci



Ispitni znak (vidi stranu 33)





Završna montaža (vidi stranu 35)



Montaža vidi stranu 32



Sikkerhetshenvisninger

-  Bruk hansker under montasjen for å unngå klem- og kuttskader.
-  Store trykkdifferanser mellom kaldt- og varmtvannstilkoblinger skal utlignes.

Montagehenvisninger

- Armaturen skal monteres, spyles og sjekkes iht. gyldige standarder.
- Før montasjen skal produktet sjekkes for transportskader. Etter monteringen aksepteres ikke noen transport- eller overflateskader.
- Armaturen skal monteres isolert og støyfrikoblet.

Montasje-eksempel (se side 31)

Montasje (se side 32)

1. Innbygd og kontrollert Trio pusses over, hhv. ved installasjon foran veggen dekkes det til med panel. Etter tørking av pusset veggoverflate skal sprekken mellom veggen og tetningshylsen til innfelt ventil tettes med silikon (uten eddiksyre!).
2. PCI-Lastogum eller en lignende tetningmasse påføres veggen iht. produsentforskrifter.
3. Tetningsmansjett trekkes over tetningshylsen og trykkes inn i limet og silikonet.

Obs! Tetningsmansjett må aldri limes varm.

Hvis Trio Stop av- / omstilling skal limes inn varm, skal man passe på at den ikke skades.

Symbolbeskrivelse



Ikke bruk silikon som inneholder eddiksyre!



Mål (se side 33)



Servicedeler (se side 34)



Ekstratilbehør

Forlengelse (Artikkelnummer 96370000) ikke med i leveransen



Prøvemerket (se side 33)



Sluttmontasje (se side 35)



Montasje se side 32



Указания за безопасност

- ⚠ При монтажа трябва да се носят ръкавици, за да се избегнат наранявания поради притискане или порязване.
- ⚠ Големите разлики в налягането между изводите за студената и топлата вода трябва да се изравняват.

Указания за монтаж

- Арматурата трябва да се монтира, промие и провери в съответствие с валидните норми.
- Преди монтажа продуктът трябва да се провери за транспортни щети. След монтажа не се признават транспортни или повърхностни щети.
- Арматурата трябва да се монтира изолирана и не свързана с шум.

Примери за монтаж (вижте стр. 31)

Монтаж (вижте стр. 32)

1. Нанесете мазилка върху монтираната и проверена Trio или я облицовайте с панел при монтаж пред стена.
След изсъхване на мазилката на повърхността на стената, мястото на свързване между стената и уплътняващата втулка на клапана за полагане в мазилката да се напръска със силикон (без оцетна киселина!).
2. На стената да се нанесе PCI-Lastogum или уплътняващ материал, подобен на него по данни на производителя.
3. Уплътнителният маншет да се нахлузи на уплътняващата втулка и да се залепи със силикон като се притисне.

Внимание! Уплътнителният маншет не трябва да се лепи по топъл начин.

В случай, че спирането / превключването Trio Stop трябва да бъде залепено по топлия начин, внимавайте да не го повредите.

Описание на символите



Не използвайте силикон, съдържащ оцетна киселина!



Размери (вижте стр. 33)



Сервизни части (вижте стр. 34)



Специални принадлежности

Удължител (Номенклатурен номер 96370000) не се съдържа в обема на доставка



Контролен знак (вижте стр. 33)



Довършителен монтаж (вижте стр. 35)



Монтаж вижте стр. 32



Udhëzime sigurie

- △ Për të evituar lëndimet e pickimeve ose të prerjeve gjatë procesit të montimit duhet që të vishni doreza.
- △ Ndryshimet e mëdha të presionit mes lidhjeve të ujit të ftohtë dhe atij të ngrohtë duhen ekuilibruar.

Udhëzime për montimin

- Armatura duhet montuar, shpërlarë dhe kontrolluar në bazë të normave të vlefshme.
- Përpara montimit duhet që produkti të kontrollohet për dëmtime nga transporti. Pas instalimit nuk do të njihet asnjë dëmtim nga transporti ose dëmtim i sipërfaqes.
- Valvula duhet të izolohet dhe të izoluar akustikisht montuar.

Shembuj të montimit (shih faqen 31)

Montimi (shih faqen 32)

1. Suvatoni Trion e montuar dhe të kontrolluar, respektivisht mbulojeni me panele, nëse instalimi bëhet jashtë murit. Pas tharjes së sipërfaqes së murit të suvatuar duhet izoluar me silikon (pa acid acetik!) pika e bashkimit midis murit dhe mbështjellëses izoluese të valvulës së fshehur.
2. Lyeni murin me PCI-Lagostum ose me ndonjë lëndë të ngjashme izoluese.
3. Vini manshetën izoluese mbi gëzhojën izoluese dhe shtypeni në ngjithësin dhe silikonin.

Kujdes! Mansheta izoluese nuk duhet ngjitur me ngjithës të nxehtë.

Nëse ndërruesi i pozicionit të Trios ngjitet me ngjithës së nxehtë, atëherë duhet pasur kujdes që të mos dëmtohet.

Përshkrimi i simbolit



Mos përdorni silikon që në përbërje ka acid acetik.



Përmasat (shih faqen 33)



Pjesë ndërrimi (shih faqen 34)



Pajisje të posaçme

Zgjatës (Numri i artikullit 96370000) nuk përfshihet në vëllimin e furnizimit



Shenja e kontrollit (shih faqen 33)



Montimi përfundimtar (shih faqen 35)



Montimi shih faqen 32



التركيب (راجع صفحة 32)

1. يجب أن يكون التوصيل مناسباً للجلب المسطحة.
بعد جفاف ملاط سطح الحائط
يجب سد نقطة الإلتصاق بين الحائط وجليبة الإغلاق للصمام
تحت الملاط بالسليكون (خال من الخل الحمضي!)
2. قم بوضع مادة PCI-Lastogum أو أي مركب مانع
للتسرب على الجدار وفقاً لتعليمات الشركة المنتجة.
3. ضع جليبة منع التسرب على الغطاء المانع للتسرب واضغط
عليها في المادة اللاصقة والسليكون.
تنبيه! لا يسمح بلمس الكم المانع للتسرب على الساخن.
يجب الأخذ في الإعتبار عدم الإضرار بوحدة
الإغلاق أو التغيير الثلاثية، إذا كان من الضروري اللصق
بمادة لاصقة ساخنة.

تنبيهات الأمان



- يجب إرتداء قفازات لليد أثناء التركيب لتجنب حدوث
أخطار الإنحشار أو الجروح.
- يجب أن يكون تيار الماء الساخن والماء البارد متعادلين في
الضغط.



تعليمات التركيب

- يجب تركيب الوصلة واستخدامها واختبارها وفقاً للمعايير
المعمول بها.
- قبل القيام بعملية التركيب، يجب فحص المنتج للتأكد من
خلوه من أية تلفيات ناتجة عن النقل. بعد القيام بعملية
التركيب، لن يتم الاعتراف بوجود أية تلفيات سطحية أو
تلفيات ناتجة عن عملية النقل.
- يجب تركيب خلاط المياه بعد عزله وفصله عن الاحتكاكات
بمواد البناء داخل المكان الذي يركب به.
مثال على التركيب (راجع صفحة 31)

وصف الرمز

هام! لا تستخدم السليكون الذي يحتوي على
أحماض!



أبعاد (راجع صفحة 33)



قطع الغيار (راجع صفحة 34)



ملحقات خاصة

وصلة إطالة (رقم الصنف 96370000) غير
مدرج مع المحتويات المسلمة



شهادة اختبار (راجع صفحة 33)



التجميع النهائي (راجع صفحة 35)



التركيب راجع صفحة 32



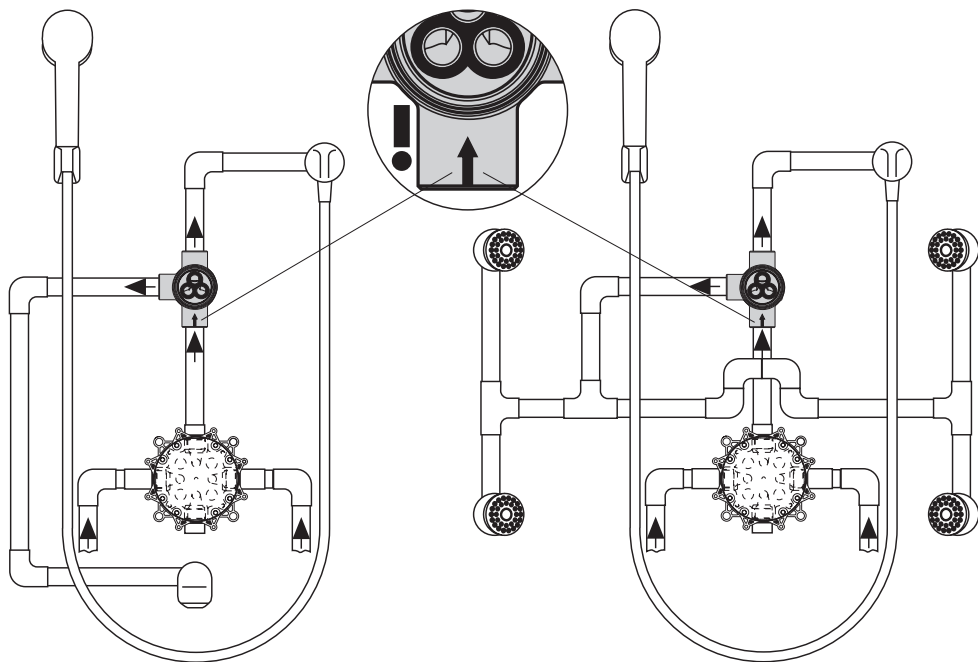



Schallentkopplung / silencieux / noise reduction / sorbente acusticor / Silenciador / ruisdemper / Lyddkoblingen /
Isolamento acústico / Odsprężenie akustyczne / Zvukové odstínění / Zvukové odtienenie / 隔音装置 /
Шумоізоляція / Zajmentesító / Äänieriste / Isolering / Garso slopinimas / Zvučna izolacija / Ses ayırma /
Izolare fonică / Ηχομόωση / Ločitev zvoka / Müraisolatsioon / Skaņu slāpējošs pieslēgums / Zvučna izolacija /
Støyavkobling / Заглушитель / Ndarësi i ekos / تحويل صدی الصوت

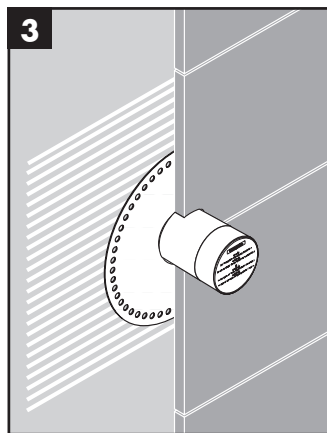
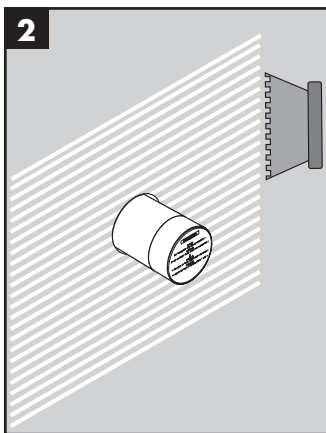
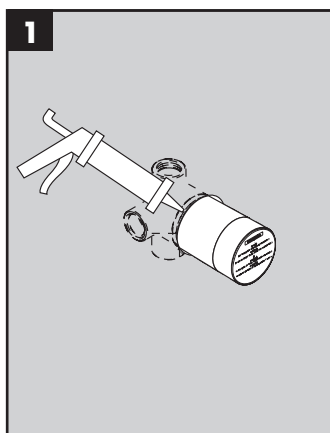
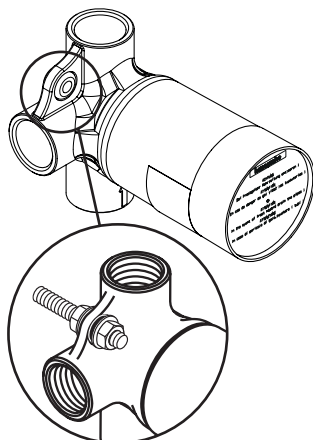
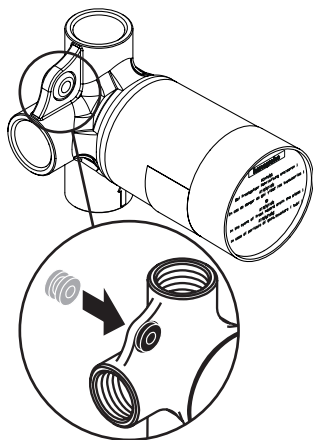

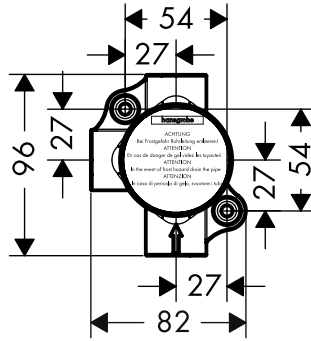
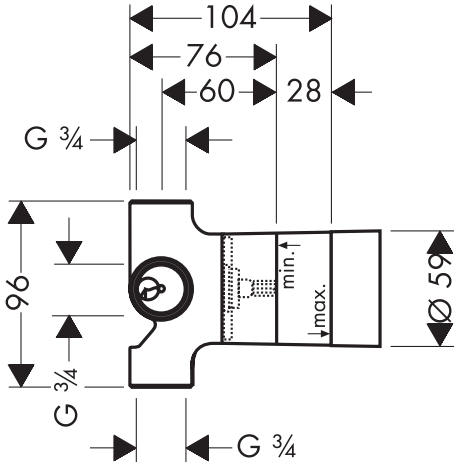

	P-IX	DVGW	SVGW	WRAS	KIWA	NF	ACS	ETA
15981180			X	X			X	

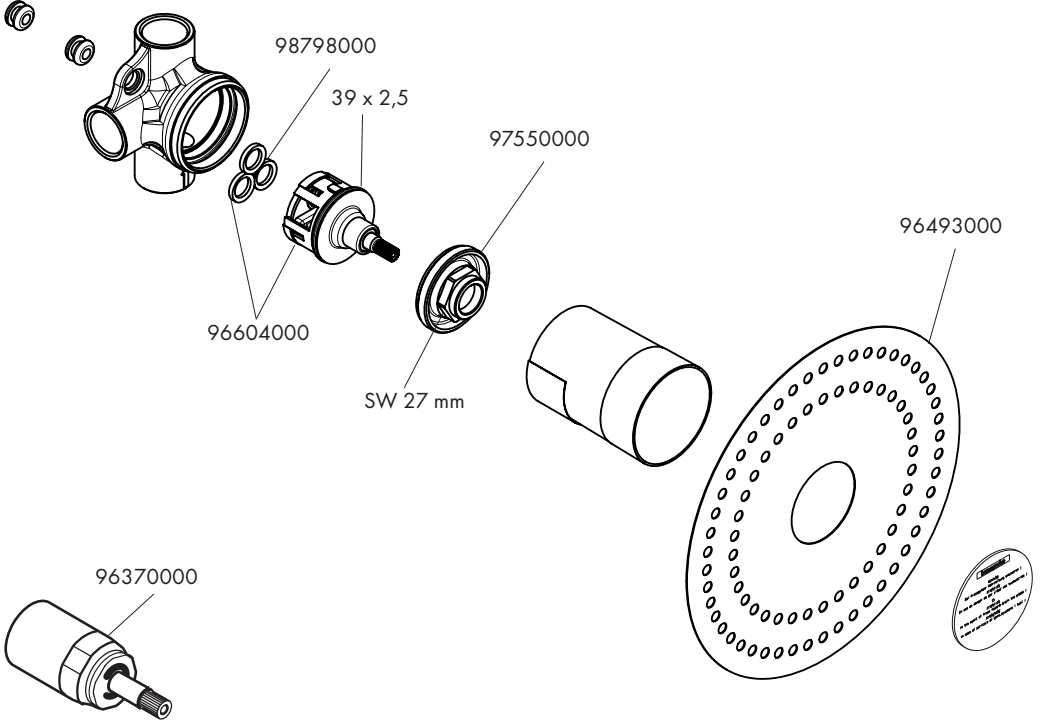



Starck
10930000

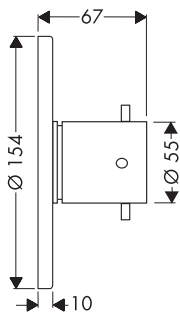

Starck
10932000

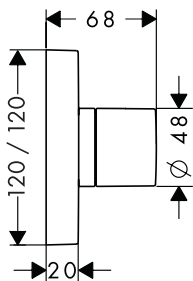

Starck X
10934000

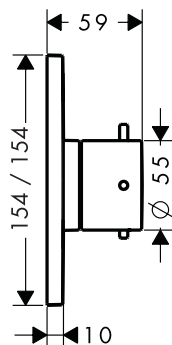

Urquiola
11925000

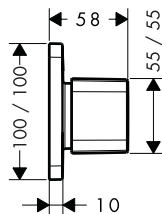

Trio / Quattro E
15931000

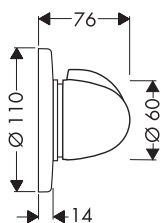

Trio / Quattro Classic
15934XXX

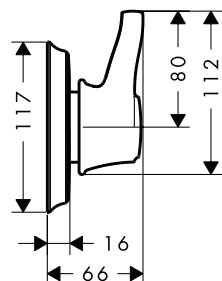

Trio / Quattro PuraVida
15937XXX

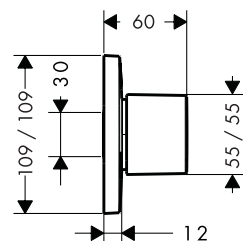

Trio / Quattro S
15932000

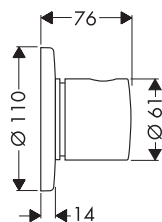

Montreux
16830XXX

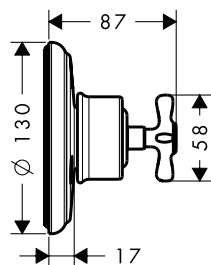

Carlton
17920XXX

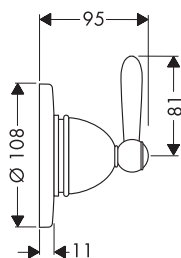

Carlton
17925XXX

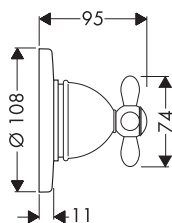

Massaud
18730000

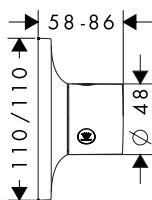



Trio /Quattro Metris
31634000

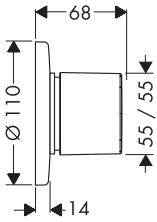

Citterio M
34920000

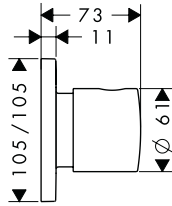

Steel
35930800

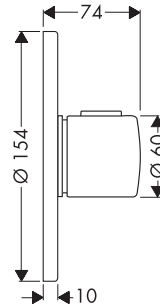

Uno
38933000

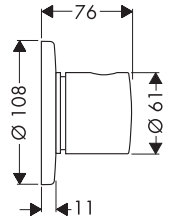

Citterio
39920000

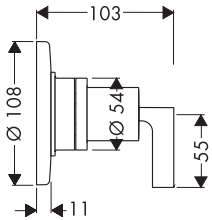

Citterio
39925000

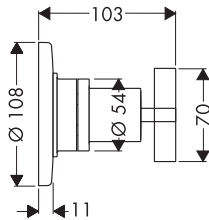

Bouroullec
19981000

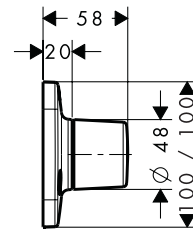

hansgrohe