

DE / Montageanleitung	02
FR / Instructions de montage	03
EN / assembly instructions	04
IT / Istruzioni per Installazione	05
ES / Instrucciones de montaje	06
NL / Handleiding	07
DK / Monteringsvejledning	08
PT / Manual de Instalação	09
PL / Instrukcja montażu	10
CS / Montážní návod	11
SK / Montážny návod	12
ZH / 组装说明	13
RU / Инструкция по монтажу	14
FI / Asennusohje	15
SV / Monteringsanvisning	16
LT / Montavimo instrukcijos	17
HR / Uputstva za instalaciju	18
TR / Montaj kılavuzu	19
RO / Instrucțiuni de montare	20
EL / Οδηγία συναρμολόγησης	21
SL / Navodila za montažo	22
ET / Paigaldusjuhend	23
LV / Montāžas instrukcija	24
SR / Uputstvo za montažu	25
NO / Montasjeveiledning	26
BG / Ръководство за монтаж	27
SQ / Udhëzime rreth montimit	28
AR / تعليمات التجميع	29
HU / Szerelési útmutató	30

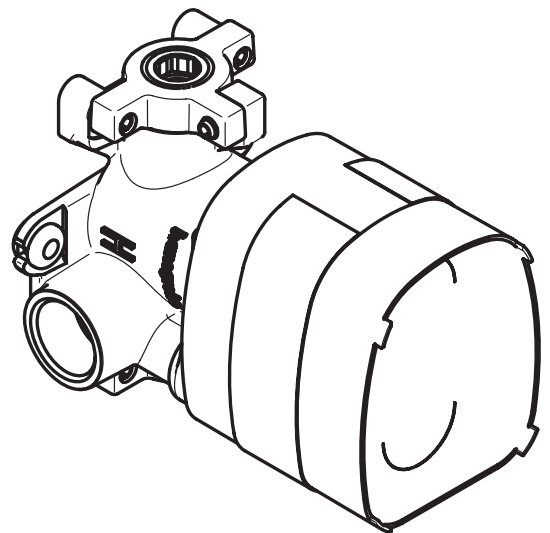

AXOR ShowerCollection
10754180

⚠ SICHERHEITSHINWEISE

- ⚠ Bei der Montage müssen zur Vermeidung von Quetsch- und Schnittverletzungen Handschuhe getragen werden.
- ⚠ Das Produkt darf nur zu Bade-, Hygiene- und Körperreinigungszwecken eingesetzt werden.
- ⚠ Kinder, sowie Erwachsene mit körperlichen, geistigen und/oder sensorischen Einschränkungen dürfen das Produkt nicht unbeaufsichtigt benutzen. Personen, die unter Alkohol- oder Drogeneinfluss stehen, dürfen das Produkt nicht benutzen.
- ⚠ Große Druckunterschiede zwischen den Kalt- und Warmwasseranschlüssen müssen ausgeglichen werden.

MONTAGEHINWEISE









- / Vor der Montage muss das Produkt auf Transportschäden untersucht werden. Nach dem Einbau werden keine Transport- oder Oberflächenschäden anerkannt.
- / Die Leitungen und die Armatur müssen nach den gültigen Normen montiert, gespült und geprüft werden.
- / Die in den Ländern jeweils gültigen Installationsrichtlinien sind einzuhalten.
- / Bei der Montage des Produktes durch qualifiziertes Fachpersonal ist darauf zu achten, dass die Befestigungsfläche im gesamten Bereich der Befestigung plan ist (keine vorstehenden Fugen oder Fliesenversatz), der Wandaufbau für eine Montage des Produktes geeignet ist und keine Schwachstellen aufweist.
- / Beim Bohren auf Strom- und Wasserleitungen achten!
- / Die Ablaufleistung muss ausreichend dimensioniert werden.

TECHNISCHE DATEN

Betriebsdruck:	max. 1 MPa
Empfohlener Betriebsdruck:	0,1 - 0,5 MPa
Prüfdruck:	1,6 MPa (1 MPa = 10 bar = 147 PSI)
Heißwassertemperatur:	max. 70°C
Empfohlene Heißwassertemperatur:	65°C
Anschlüsse:	G1/2 & G3/4
Durchflussleistung bei 0,3 MPa:	58 l/min
10754180	
Thermische Desinfektion:	max. 70°C/4 min

- / Eigensicher gegen Rückfließen
- / Das Produkt ist ausschließlich für Trinkwasser konzipiert!

SYMBOLERKLÄRUNG

-  Kein essigsäurehaltiges Silikon verwenden!
-  MASSE (siehe Seite 17)
-  SERVICETEILE (siehe Seite 37)
-  MONTAGEBEISPIELE (siehe Seite 18)
Die Anordnung der Module den baulichen Gegebenheiten anpassen.
-  Wasseranschluss DN20
-  Warmwasser
-  Wasseranschluss DN20
Kaltwasser
-  MITTE DUSCHWANNE
-  WASSER ÖFFNEN / WASSER ABSTELLEN
-  SCHUTZHANDSCHUHE TRAGEN
-  MONTAGEABFOLGE
-  ABGÄNGE ABSTOPFEN
Der nicht benötigte Abgang muss mit einem Blindstopfen abgedichtet werden.
-  % LEITUNGSGEFÄLLE
Wasserleitungen für Seitenbrausen mit Gefälle verlegen.
-  WANDVERSTÄRKUNG NOTWENDIG
In diesem Bereich ist eine Wandverstärkung notwendig.
-  PRÜFZEICHEN (siehe Seite 17)

⚠ CONSIGNES DE SÉCURITÉ

- ⚠ Lors du montage, porter des gants de protection pour éviter toute blessure par écrasement ou coupure.
- ⚠ Le produit ne doit servir qu'à se laver et à assurer l'hygiène corporelle.
- ⚠ Il est interdit aux enfants ainsi qu'aux adultes ayant des insuffisances physiques, psychiques et/ou motoriques d'utiliser la douche sans surveillance. De même, il est interdit à des personnes sous influence d'alcool ou de drogues d'utiliser la douche.
- ⚠ Il est conseillé d'équilibrer les pressions de l'eau chaude et froide.

INSTRUCTIONS POUR LE MONTAGE

- / Avant son montage, s'assurer que le produit n'a subi aucun dommage pendant le transport. Après le montage, tout dommage de transport ou de surface ne pourra pas être reconnu.
- / Les conduites et la robinetterie doivent être montés, rincés et contrôlés selon les normes en vigueur.
- / Les directives d'installation en vigueur dans le pays concerné doivent être respectées.
- / Lors du montage de ce produit par du personnel qualifié, veiller à ce que la surface de fixation soit bien plane dans toute la zone de fixation (pas de dépassement de joints ou de déport de carreaux), à ce que le mur se prête au montage du produit et ne présente aucun point fragile.
- / Lors de travaux de perçage sur des conduites électriques et des conduites d'eau!
- / Le débit du vidage doit être suffisamment dimensionné.

INFORMATIONS TECHNIQUES

Pression de service autorisée:	max. 1 MPa
Pression de service conseillée:	0,1 - 0,5 MPa
Pression maximum de contrôle:	1,6 MPa (1 MPa = 10 bar = 147 PSI)
Température d'eau chaude:	max. 70°C
Température recommandée:	65°C
Raccordement:	G1/2 & G3/4
Débit à 0,3 MPa:	58 l/min
10754180	
Désinfection thermique:	max. 70°C/4 min

- / Avec dispositif anti-retour
- / Le produit est exclusivement conçu pour de l'eau potable!

DESCRIPTION DU SYMBOLE

-  Ne pas utiliser de silicone contenant de l'acide acétique!
-  DIMENSIONS (voir pages 17)
-  PIÈCES DÉTACHÉES (voir pages 37)
-  EXEMPLES DE MONTAGE (voir pages 18)
Adapter la disposition des modules aux conditions locales
-  Raccord d'eau DN20
-  Eau chaude
-  Raccord d'eau DN20
Eau froide
-  CENTRE CUVETTE DE DOUCHE
-  OUVRIR L'EAU. / COUPER L'ARRIVÉE D'EAU
-  PROTECTION OBLIGATOIRE DES MAINS
-  ORDRE DU MONTAGE
-  OBTURER LES SORTIES
La sortie non utilisée doit être condamnée avec un bouchon laiton.
-  % DÉNIVELLATION DES CONDUITES
La tuyauterie des douchettes latérales à installer avec une pente.
-  RENFORCEMENT DE LA PAROI NÉCESSAIRE
Le mur n'a pas besoin d'être renforcé à cet endroit
-  CLASSIFICATION ACOUSTIQUE ET DÉBIT
(voir pages 17)

⚠ SAFETY NOTES

- ⚠ Gloves should be worn during installation to prevent crushing and cutting injuries.
- ⚠ The product may only be used for bathing, hygienic and body cleaning purposes.
- ⚠ Children as well as adults with physical, mental and/or sensoric impairments must not use this product without proper supervision. Persons under the influence of alcohol or drugs are prohibited from using this product.
- ⚠ The hot and cold supplies must be of equal pressures.



INSTALLATION INSTRUCTIONS

- / Prior to installation, inspect the product for transport damages. After it has been installed, no transport or surface damage will be honoured.
- / The pipes and the fixture must be installed, flushed and tested as per the applicable standards.
- / The plumbing codes applicable in the respective countries must be observed.
- / During installation of the product by qualified trained personnel, make sure that the entire fastening surface is even and smooth (no protruding seams or tile offset), that the finish of the wall is suitable to apply the product and has no weak points.
- / Observe all current and water lines when drilling!
- / The performance of the waste must be of sufficient size.

TECHNICAL DATA

Operating pressure:	max. 1 MPa
Recommended operating pressure:	0,1 - 0,5 MPa
Test pressure:	1,6 MPa (1 MPa = 10 bar = 147 PSI)
Hot water temperature:	max. 70°C
Recommended hot water temp.:	65°C
Connections:	G1/2 & G3/4
Rate of flow by 0,3 MPa:	58 l/min
10754180	
Thermal disinfection:	max. 70°C / 4 min
/ Safety against backflow	
/ The product is exclusively designed for drinking water!	

SYMBOL DESCRIPTION

-  Do not use silicone containing acetic acid!
-  DIMENSIONS (see page 17)
-  SPARE PARTS (see page 37)
-  INSTALLATION EXAMPLE (see page 18)
Adjust the module arrangement to the local conditions
-  Water connection DN20
-  Warm water
-  Water connection DN20
-  Cold water
-  CENTER SHOWER TUB
-  TURN ON WATER / TURN OFF WATER
-  SAFETY GLOVES MUST BE WORN
-  INSTALLATION SEQUENCE
-  PLUG OUTLETS
Plug the unused outlet.
-  PIPE DECLINE
Install water pipes for body showers with a gradient.
-  AREA FOR REQUIRED WALL REINFORCEMENT
The wall must be reinforced in this area.
-  TEST CERTIFICATE (see page 17)



⚠ INDICAZIONI SULLA SICUREZZA

- ⚠ Durante il montaggio, per evitare ferite da schiacciamento e da taglio bisogna indossare guanti protettivi.
- ⚠ Il prodotto deve essere utilizzato esclusivamente per fare il bagno e per l'igiene del corpo.
- ⚠ I bambini e gli adulti affetti da menomazioni fisiche, psichiche e/o sensoriali devono utilizzare il sistema doccia solo sotto sorveglianza. Il prodotto non deve essere utilizzato da persone sotto l'effetto di droghe o alcolici.
- ⚠ Attenzione! Compensare le differenze di pressione tra i collegamenti dell'acqua fredda e dell'acqua calda.

ISTRUZIONI PER IL MONTAGGIO

- / Prima del montaggio è necessario controllare che non ci siano stati danni durante il trasporto. Una volta eseguito il montaggio, non verranno riconosciuti eventuali danni di trasporto o delle superfici.
- / Montare, lavare e controllare tubature e rubinetteria rispettando le norme correnti.
- / Vanno rispettate le direttive di installazione nazionali vigenti nel rispettivo paese.
- / Per il montaggio del prodotto da personale specializzato qualificato bisogna fare attenzione, che la superficie di fissaggio, in tutto il campo di fissaggio, sia piana (nessuna giunzione sporgente o sfalsamento di piastrella), la costruzione della parete sia adatta al montaggio del prodotto e che non presenti alcun punto debole.
- / Nel praticare i fori attenzione a non danneggiare linee elettriche ed idriche!
- / Lo scarico deve essere sufficientemente dimensionato.

DATI TECNICI

Pressione d'uso:	max. 1 MPa
Pressione d'uso consigliata:	0,1 - 0,5 MPa
Pressione di prova:	1,6 MPa (1 MPa = 10 bar = 147 PSI)
Temperatura dell'acqua calda:	max. 70°C
Temp. dell'acqua calda consigliata:	65°C
Raccordi:	G1/2 & G3/4
Potenza di erogazione a 0,3 MPa:	58 l/min
10754180	
Disinfezione termica:	max. 70°C / 4 min

- / Sicurezza antiriflusso
- / Il prodotto è concepito esclusivamente per acqua potabile!

DESCRIZIONE SIMBOLO

-  Non utilizzare silicone contenente acido acetico!
-  INGOMBRI (vedi pagg. 17)
-  PARTI DI RICAMBIO (vedi pagg. 37)
-  ESEMPIO DI INSTALLAZIONE (vedi pagg. 18)
Adattare la disposizione dei moduli alle circostanze architettoniche.
-  Allacciamento acqua DN20
-  Acqua calda
-  Allacciamento acqua DN20
-  Acqua fredda
-  CENTRO PIATTO DOCCIA
-  APRIRE L' ACQUA / CHIUDERE L' ACQUA
-  INDOSSARE GUANTI DI PROTEZIONE
-  SEQUENZA DI MONTAGGIO
-  TAPPARE LE USCITE
Chiudere con un tappo l'uscita non utilizzata.
-  PENDENZA TUBI
Posizionare i tubi alle doccette laterali con una leggera pendenza.
-  CAMPO RINFORZO NECESSARIO DELLA PARETE
In questa zona è necessario un rinforzo della parete.
-  SEGNO DI VERIFICA (vedi pagg. 17)



INDICACIONES DE SEGURIDAD

- ⚠ Durante el montaje deben utilizarse guantes para evitar heridas por aplastamiento o corte.
- ⚠ El producto solo debe ser utilizado para fines de baño, higiene y limpieza corporal.
- ⚠ Niños, así como adultos con limitaciones corporales, mentales y/o sensoriales no deben utilizar el sistema de duchas sin vigilancia. Personas que se encuentran bajo el efecto de alcohol o drogas, no deben utilizar el sistema de duchas.
- ⚠ Grandes diferencias de presión en servicio entre agua fría y agua caliente deben equilibrarse.

INDICACIONES PARA EL MONTAJE

















- / Antes del montaje se debe examinar el producto contra daños de transporte. Después de la instalación no se reconoce ningún daño de transporte o de superficie.
- / Los conductos y la grifería deben montarse, lavarse y comprobarse según las normas vigentes.
- / Es obligatorio el cumplimiento de las directrices de instalación vigentes en el país respectivo.
- / Durante el montaje del producto, mediante personal especializado, se debe asegurar de que la superficie de sujeción en todo el área de la fijación sea plana (sin fugas o azulejos que sobresalgan), que la estructura del muro sea adecuada para el montaje del producto y que no presente puntos débiles.
- / ¡Prestar especial atención al taladrar cerca de conductos eléctricos o de agua!
- / La tubería de desagüe ha de tener una dimensión suficiente.

DATOS TÉCNICOS

Presión en servicio:	max. 1 MPa
Presión recomendada en servicio:	0,1 - 0,5 MPa
Presión de prueba:	1,6 MPa (1 MPa = 10 bar = 147 PSI)
Temperatura del agua caliente:	max. 70°C
Temp. recomendada del agua caliente:	65°C
Racores excéntricos:	G1/2 & G3/4
Caudal a 0,3 MPa:	58 l/min
Desinfección térmica:	max. 70°C/4 min

- / Seguro contra el retorno
- / El producto ha sido concebido exclusivamente para agua potable.

DESCRIPCIÓN DE SÍMBOLOS

-  No utilizar silicona que contiene ácido acético!
-  DIMENSIONES (ver página 17)
-  REPUESTOS (ver página 37)
-  EJEMPLOS DE MONTAJE (ver página 18)
Adaptar la disposición de los módulos a las condiciones constructivas.
-  Conexión de agua DN20
-  Agua caliente
-  Conexión de agua DN20
-  Agua fría
-  CENTRO LA PLATO DE DUCHA
-  ABRIR EL AGUA / CERRAR EL AGUA
-  PROTECCIÓN OBLIGATORIA DE LA VISTA
-  SECUENCIA DE MONTAJE
-  LLENAR SALIDAS
La salida que no se utiliza debe ser tapada.
-  PENDIENTE DE LA CONDUCCIÓN
Tubería hacia las duchas laterales con pendiente.
-  ÁREA REFUERZO NECESARIO DE LA PARED
En este sector es necesario un refuerzo del muro.
-  MARCA DE VERIFICACIÓN (ver página 17)

VEILIGHEIDSIINSTRUCTIES

- ⚠ Bij de montage moeten ter voorkoming van knel- en snijwonden handschoenen worden gedragen.
- ⚠ Het product mag alleen voor het wassen, hygiënische doeleinden en voor de lichaamreiniging worden gebruikt.
- ⚠ Kinderen en volwassenen met lichamelijke, geestelijke en/of sensorische beperkingen mogen het douchesysteem niet zonder toezicht gebruiken. Personen onder invloed van alcohol of drugs mogen het douchesysteem niet gebruiken.
- ⚠ Grote drukverschillen tussen de koud- en warmwatertoevoer dienen vermeden te worden.

MONTAGE-INSTRUCTIES

- / Vóór de montage moet het product gecontroleerd worden op transportschade. Na de inbouw wordt geen transport- of oppervlakteschade meer aanvaard.
- / De leidingen en armaturen moeten gemonteerd, gespoeld en gecontroleerd worden volgens de geldige normen.
- / De in de overeenkomstige landen geldende installatierichtlijnen moeten nageleefd worden.
- / Bij de montage van het product door gekwalificeerd vakpersoneel moet erop gelet worden dat het montagevlak in het volledige bereik van de bevestiging vlak is (geen uitstekende voegen of verspringende tegels), dat de wand geschikt is voor de montage van het product en geen zwakke plaatsen vertoont.
- / Bij het boren in stroom- en waterleidingen
- / De afvoercapaciteit moet voldoende gedimensioneerd worden.

TECHNISCHE GEGEVENS

Werkdruk: max.	max. 1 MPa
Aanbevolen werkdruk:	0,1 - 0,5 MPa
Getest bij:	1,6 MPa (1 MPa = 10 bar = 147 PSI)
Temperatuur warm water:	max. 70°C
Aanbevolen warm water temp.:	65°C
Aansluitingen:	G1/2 & G3/4
Doorvoercapaciteit bij 0,3 MPa:	58 l/min
Thermische desinfectie:	max. 70°C/4 min

- / Beveiligd tegen terugstromen
- / Het product is uitsluitend ontworpen voor drinkwater!

SYMBOOLBESCHRIJVING

-  Gebruik geen zuurhoudende silicone!
-  MATEN (zie blz. 17)
-  SERVICE ONDERDELEN (zie blz. 37)
-  MONTAGEVOORBEELDEN (zie blz. 18)
De rangschikking van de modules moet aan de bouwtechnische omstandigheden worden aangepast
-  Wateraansluiting DN20
-  Warm water
-  Wateraansluiting DN20
-  Koud water
-  MIDDEN DOUCHEBAK
-  HOOFDKRAAN OPENEN / WATER AFSLUITEN
-  VEILIGHEIDSHANDSCHOENEN VERPLICHT
-  MONTAGEVOLGORDE
-  AFTAPPUNT AFSLUITEN
De niet benodigde uitgang moet met een blindstop worden afgedicht.
-  LEIDINGSAFLOOP
Waterleidingen voor zijdouches aflopend plaatsen.
-  WANDVERSTERKING NOODZAKELIJK VOOR MONTAGE
In dit bereik is een wandversterking noodzakelijk.
-  KEURMERK (zie blz. 17)

⚠ SIKKERHEDSANVISNINGER

- ⚠ Ved monteringen skal der bruges handsker for at undgå kvæstelser og snitsår.
- ⚠ Produktet må kun bruges til bade-, hygiejne og kropsrengøringsformål.
- ⚠ Børn som også voksne med fysiske, mentale og/eller sensoriske begrænsninger må ikke bruge brusersystemet uden opsyn. Personer som er under indflydelse af alkohol eller narkotika må ikke bruge brusersystemet.
- ⚠ Større trykforskelle mellem koldt og varmt vand bør udjævnes.

MONTERINGSANVISNINGER

- / Før monteringen skal produktet kontrolleres for transportskader. Efter monteringen godkendes transportskader eller skader på overfladen ikke længere.
- / Ledningerne og armaturerne skal monteres, skylles og kontrolleres iht. de gældende standarder.
- / Installationsbestemmelserne, der gælder i det enkelte land, skal overholdes.
- / Ved montering af produktet igennem kvalificerede fagfolk skal der holdes øje med, at fastgørelsesoverfladen er plan i alle områder hvor produktet monteres (ingen fremragende fuger eller fliseforskydninger), at væggene er velegnet til monteringen af produktet og ikke har svare områder.
- / Pas på strøm- og vandledninger ved boring!
- / Afløbet skal være i en tilstrækkelig størrelse.

TEKNISKE DATA

Driftstryk:	max. 1 MPa
Anbefalet driftstryk:	0,1 - 0,5 MPa
Prøvetryk:	1,6 MPa (1 MPa = 10 bar = 147 PSI)
Varmtvandstemperatur:	max. 70°C
Anbefalet varmtvandsstemperatur:	65°C
Tilslutninger:	G1/2 & G3/4
Gennemstrømningsydelse ved 0,3 MPa:	58 l/min
10754180	max. 70°C/4 min
Termisk desinfektion:	
/ Med indbygget konventil	
/ Produktet er udelukkende beregnet til drikkevand!	

SYMBOLBESKRIVELSE

 Der må ikke benyttes eddikesyreholdig silikone!

 MÅLENE (se s. 17)

 RESERVEDELE (se s. 37)

 MONTERINGSEKSEMPLER (se s. 18)
Tilpasse modulernes arrangement til bygningsituationen.

 Vandtilslutning DN20

Varmt vand

 Vandtilslutning DN20

Kold vand

 MIDT BRUSEKAR

 TÆND FOR VANDET / LUK FOR VANDET

 BESKYTTELSESHANDSKER PÅBUDT

 MONTERINGSRÆKKEFØLGE

 PROPPE AFLØB
Afgangen, der ikke benyttes, skal afproppes.

 LEDNINGSFALD
Vandledningerne til sidebruserne med fald.

 OMRÅDE NØDVENDIGVÆGFORSTÆRKNING
I dette område er en forstærkning af væggen nødvendigt.

 GODKENDELSE (se s. 17)

⚠ AVISOS DE SEGURANÇA

- ⚠ Durante a montagem devem ser utilizadas luvas de protecção, de modo a evitar ferimentos resultantes de entalamentos e de cortes.
- ⚠ O produto só pode ser utilizado para fins de higiene pessoal.
- ⚠ Crianças e adultos com deficiências motoras, mentais e/ou sensoriais não podem utilizar o sistema de duche sem monitorização. Pessoas que estejam sob a influência de álcool ou drogas não podem utilizar o sistema de duche.
- ⚠ Grandes diferenças entre as pressões das águas quente e fria devem ser compensadas.

AVISOS DE MONTAGEM

- / Antes da montagem deve-se controlar o produto relativamente a danos de transporte. Após a montagem não são aceites quaisquer danos de transporte ou de superfície.
- / As tubagens e a torneira têm que ser montadas, enxaguadas e verificadas de acordo com as normas em vigor.
- / A prescrições de instalação válidas nos respetivos países devem ser respeitadas.
- / Durante a montagem efectuada por técnicos qualificados deve ter-se em atenção que a superfície de fixação seja plana em toda a sua extensão (sem juntas ou ladrilhos salientes), que a estrutura da parede seja adequada para a montagem do produto e que não apresente pontos fracos.
- / Ter atenção a instalações eléctricas e de água durante os trabalhos de perfuração!
- / A capacidade de escoamento deve ser devidamente dimensionada.

DADOS TÉCNICOS

Pressão de funcionamento:	max. 1 MPa
Pressão de func. recomendada:	0,1 - 0,5 MPa
Pressão testada:	1,6 MPa (1 MPa = 10 bar = 147 PSI)
Temperatura da água quente:	max. 70°C
Temp. água quente recomendada:	65°C
Ligações:	G1/2 & G3/4
Caudal a 0,3 MPa:	58 l/min
10754180	max. 70°C/4 min
Desinfecção térmica:	

- / Função anti-retorno e anti-vácuo
- / Este produto foi única e exclusivamente concebido para água potável!

DESCRIÇÃO DO SÍMBOLO

 Não utilizar silicone que contenha ácido acético!

 MEDIDAS (ver página 17)

 PEÇAS DE SUBSTITUIÇÃO (ver página 37)

 EXEMPLOS DE MONTAGEM (ver página 18)
Adaptar a disposição dos módulos às características locais.

 Ligação da água DN20

Água quente

 Ligação da água DN20

Água fria

 MEIO DA BASE DE DUCHE

 ABRIR A ÁGUA / CORTAR A ÁGUA

 PROTECÇÃO OBRIGATÓRIA DAS MÃOS

 SEQUÊNCIA DE MONTAGEM

 TAPAR SAÍDAS
Tamponar a saída não utilizada.

 INCLINAÇÃO DA TUBAGEM
Instalar os tubos para os chuveiros laterais com ligeira inclinação.

 ÁREA REFORÇADA NECESSÁRIA DA PAREDE
Nesta zona é necessário um reforço na parede.

 MARCA DE CONTROLO (ver página 17)

Δ WSKAZÓWKI BEZPIECZEŃSTWA

- Δ Aby uniknąć zranień na skutek zgniecenia lub przecięcia, podczas montażu należy nosić rękawice ochronne.
- Δ Produkt może być używany tylko do kąpieli, higieny i czyszczenia ciała.
- Δ Zarówno dzieci, jak i dorośli z fizycznymi, psychicznymi i/lub sensorycznymi ograniczeniami nie mogą korzystać z prysznica bez opieki. Osoby znajdujące się pod wpływem alkoholu lub narkotyków nie mogą korzystać z prysznica.
- Δ Znaczne różnice ciśnień na dopływach ciepłej i zimnej wody muszą zostać wyrównane.

WSKAZÓWKI MONTAŻOWE

- / Przed montażem należy skontrolować produkt pod kątem szkód transportowych. Po montażu nie widać żadnych szkód transportowych ani szkód na powierzchni.
- / Przewody i armatura muszą być montowane, płukane i kontrolowane według obowiązujących norm.
- / Należy przestrzegać wytycznych instalacyjnych obowiązujących w danym kraju.
- / Montaż produktu musi być wykonany przez wykwalifikowanego fachowca. Powierzchnia w miejscu montażu musi być równa (bez uskoków wzgl. wzajemnie przesuniętych płytek). Ściana w miejscu montażu musi być stabilna. Dołożone w komplecie śruby i kołki rozporowe są przeznaczone do betonu.
- / Podczas wiercenia uważać na instalacje elektryczne i wodne!
- / Odpływ musi mieć wystarczającą wydajność.

DANE TECHNICZNE

Ciśnienie robocze:	maks. 1 MPa
Zalecane ciśnienie robocze:	0,1 - 0,5 MPa
Ciśnienie próbne:	1,6 MPa (1 MPa = 10 bary = 147 PSI)
Temperatura wody gorącej:	maks. 70°C
Zalecana temperatura wody gorącej:	65°C
Przyłącza:	G1/2 & G3/4
Wydajność przepływu przy 0,3 MPa: 10754180	58 l/min
Dezynfekcja termiczna:	maks. 70°C/4 min

- / Zabezpieczony przed przepływem zwrotnym
- / Produkt przeznaczony wyłącznie do wody pitnej!

OPIS SYMBOLU

-  Nie stosować silikonów zawierających kwas octowy!
-  WYMIARY (patrz strona 17)
-  CZĘŚCI SERWISOWE (patrz strona 37)
-  PRZYKŁADY MONTAŻOWE (patrz strona 18)
Dopasować rozmieszczenie modułów do warunków budowy.
-  Podłączenie wody DN20
-  Ciepła woda
-  Podłączenie wody DN20
-  Zimna woda
-  ŚRODEK BRODZIKA
-  OTWORZYĆ WODĘ / ZAKRĘCIĆ WODĘ
-  NOSIĆ RĘKAWICE OCHRONNE
-  PRZEBIEG MONTAŻU
-  ODBLOKOWANIE ODPROWADZEŃ
Niewykorzystany wylot należy zakorkować dołożonym w dostawie korkiem.
-  SPADEK PRZEWODÓW
Przewody doprowadzające do pryszniców bocznych położyć z nachyleniem.
-  NIEZBĘDNE WZMOCNIENIE ŚCIAN
W tym obszarze konieczne jest wzmocnienie ściany.
-  ZNAK JAKOŚCI (patrz strona 17)

Δ BEZPEČNOSTNÍ POKYNY

- Δ Pro zabránění řezným zraněním a pohmožděninám je nutné při montáži nosit rukavice.
- Δ Produkt smí být používán pouze ke koupání a za účelem tělesné hygieny.
- Δ Děti a dospělí osoby s tělesným, duševním a/nebo smyslovým postižením nesmí produkt používat bez dozoru. Osoby pod vlivem alkoholu nebo drog nesmí produkt používat.
- Δ Je nutné vyrovnat velké rozdíly tlaku mezi přípojí studené a teplé vody.

POKYNY K MONTÁŽI

- / Před montáží je třeba produkt zkontrolovat, zda nebyl při transportu poškozen. Po zabudování nebudou uznány žádné škody způsobené transportem nebo poškození povrchu.
- / Vedení a armatura musí být namontovány, propláchnuty a otestovány podle platných norem.
- / Je třeba dodržovat montážní pravidla platné v dané zemi.
- / Při montáži produktu kvalifikovanou osobou je třeba dbát na to, aby byla upevňovací plocha v celé oblasti upevnění rovná (žádné vyčnívající spáry nebo zapuštění obkladů), aby struktura stěny byla vhodná pro montáž produktu a neměla žádná slabá místa.
- / Při vrtání dejte pozor na elektrická vedení a vodovodní potrubí!
- / Propustnost odpadu musí být dostatečně dimenzována.

TECHNICKÉ ÚDAJE

Provozní tlak:	maks. 1 MPa
Doporučený provozní tlak:	0,1 - 0,5 MPa
Zkušební tlak:	1,6 MPa (1 MPa = 10 bar = 147 PSI)
Teplota horké vody:	maks. 70°C
Doporučená teplota horké vody:	65°C
Přípoje:	G1/2 & G3/4
Průtokové množství při 0,3 MPa: 10754180	58 l/min
Tepelná dezinfekce:	max. 70°C/4 min

- / Vlastní jištění proti zpětnému nasátí.
- / Výrobky Hansgrohe jsou vhodné pro přímý kontakt s pitnou vodou.

POPIS SYMBOLŮ

-  Nepoužívat silikon s obsahem kyseliny octové!
-  ROZMĚRY (viz strana 17)
-  SERVISNÍ DÍLY (viz strana 37)
-  PŘÍKLADY MONTÁŽE (viz strana 18)
Uspořádání modulů přizpůsobte stavebním podmínkám.
-  Připojení vody DN20
-  Teplá voda
-  Připojení vody DN20
-  Studená voda
-  STŘED SPRCHOVÉ VANY
-  VODU ZAPOJIT / VODU ODPOJIT
-  NOSTE OCHRANNÉ RUKAVICE
-  POSTUP MONTÁŽE
-  UTĚSNIT ODPADY
Nepoužitý vývod musí být utěsněn zaslepovací zátkou.
-  SPÁD POTRUBÍ
Vodovodní potrubí pro boční sprchy nainstalovat se spádem.
-  NUTNÉ VYZTUŽENÍ STĚNY
V této oblasti je potřebné zesílení stěny.
-  ZKUŠEBNÍ ZNAČKA (viz strana 17)

△ BEZPEČNOSTNÉ POKYNY

- △ Pri montáži musíte nosiť rukavice, aby ste predišli pomliaždeninám a rezným poraneniam.
- △ Produkt sa smie používať len na kúpanie a telesnú hygienu.
- △ Produkt nesmú bez dozoru používať deti, ako aj dospelé osoby s telesným, duševným a/alebo zmyslovým postihnutím. Produkt nesmú používať ani osoby, ktoré sú pod vplyvom alkoholu alebo drog.
- △ Veľké rozdiely v tlaku medzi prípojkami studenej a teplej vody musia byť vyrovnané.

POKYNY PRE MONTÁŽ















- / Pred montážou musíte produkt skontrolovať, či nebol počas transportu poškodený. Po zabudovaní nebudú uznané žiadne škody spôsobené transportom alebo poškodenia povrchu.
- / Ledningarna och blandaren måste monteras, spolás igenom och kontrolleras enligt de gällande normerna.
- / Je potrebné dodržiavať smernice o inštalácii, ktoré sú práve teraz platné v krajinách.
- / Pri montáži produktu kvalifikovanou osobou treba dávať pozor na to, aby bola upevňovacia plocha v celej oblasti upevnenia rovná (žiadne vyčnievajúce medzery alebo zapustenia obkladov), aby štruktúra steny bola vhodná pre montáž produktu a nemá žiadne slabé miesta.
- / Pri vŕtaní dajte pozor na elektrické vedenia a vodovodné potrubia!
- / Priepustnosť odpadu musí byť dostatočne dimenzovaná.

TECHNICKÉ ÚDAJE

Prevádzkový tlak:	max. 1 MPa
Doporučený prevádzkový tlak:	0,1 - 0,5 MPa
Skúšobný tlak:	1,6 MPa (1 MPa = 10 bar = 147 PSI)
Teplota teplej vody:	max. 70°C
Doporučená teplota teplej vody:	65°C
Prípoje:	G1/2 & G3/4
Prietokové množstvo pri 0,3 MPa:	10754180
Termická dezinfekcia:	58 l/min max. 70°C / 4 min

- / Vlastná poisťka proti spätnému nasatiu.
- / Výrobok je koncipovaný výhradne pre pitnú vodu!

POPIS SYMBOLOV

-  Nepoužívať silikón s obsahom kyseliny octovej!
-  ROZMERY (viď strana 17)
-  SERVISNÉ DIELY (viď strana 37)
-  PRÍKLADY MONTÁŽE (viď strana 18)
Usporiadanie modulov prispôsobte stavebným podmienkam.
-  Prípojenie vody DN20
Teplá voda
-  Prípojenie vody DN20
Studená voda
-  STRED SPRCHOVEJ VANE
-  ZAPOJIŤ VODU / ODPOJIŤ VODU
-  NOSTE OCHRANNÉ RUKAVICE
-  POSTUP MONTÁŽE
-  UTESNIŤ ODVODY
Nepoužitý vývod musí byť zaslepený zátkou.
-  SKLON VEDENIA
Vodovodné potrubie pre bočné sprchy vyspádovaf.
-  POTREBNÉ ZOSILNENIE STENY
V tejto oblasti je potrebné zosilnenie steny.
-  OSVEDČENIE O SKÚŠKE (viď strana 17)

△ 安全技巧

- △ 装配时为避免挤压和切割受伤，必须戴上手套。
- △ 本产品只允许作为洗浴、卫生和洁身之用。
- △ 不得让儿童和肢体、精神和或意识有障碍的成人在不受监管的情况下使用淋浴系统。受酒精或毒品影响的人员不得使用淋浴系统。
- △ 冷热水管间过大的压力差必须予以平衡。

安装提示

- / 安装前必须检查产品是否受到运输损害。安装后将不认可运输损害或表面损伤。
- / 管道和阀门必须根据通用标准进行安装、冲洗和检查。
- / 请遵守当地国家现行的安装规定。
- / 由有资格的专业人员进行产品安装时请注意：在所有加固区域中，加固表面是否平整（无突出的接缝或瓷砖），墙体结构是否适合产品安装且未显露出任何缺点。
- / 钻孔时请注意电线和水管！
- / 废水管的性能必须具有充足的尺寸。

技术参数

工作压强:	最大 1 MPa
推荐工作压强:	0,1 - 0,5 MPa
测试压强:	1,6 MPa (1 MPa = 10 bar = 147 PSI)
热水温度:	最大 70°C
推荐热水温度:	65°C
连接管线:	G1/2 & G3/4
流量 钟0,3 MPa:	10754180
热力消毒:	58 升/分钟 最大 70°C / 4 分钟

- / 自动防止回流
- / 该产品专为饮用水设计！

符号说明

-  请勿使用含有乙酸的硅胶！
-  大小 (参见第页 17)
-  备用零件 (参见第页 37)
-  安装示意 (参见第页 18)
按照构造的实际情况布置模块。
-  水连接 DN20
-  热水
-  水连接 DN20
-  冷水
-  中心淋浴盆
-  调节水 / 关闭水流
-  配戴保护手套
-  装配顺序
-  堵塞支路
插入不使用的插座。
-  管道梯度
安装水管，用于带有梯度的淋浴器。
-  墙壁必要加强的区域
该区域需要一个加固边壁。
-  检验标记 (参见第页 17)

▲ УКАЗАНИЯ ПО ТЕХНИКЕ БЕЗОПАСНОСТИ

- ▲ Во время монтажа следует надеть перчатки во избежание прищемления и порезов.
- ▲ Изделие разрешается использовать только в гигиенических целях: для принятия ванны и личной гигиены.
- ▲ Дети, а также взрослые с физическими, умственными и/или сенсорными недостатками должны пользоваться изделием только под присмотром. Запрещается пользоваться изделием в состоянии алкогольного или наркотического опьянения.
- ▲ донного клапа. Перед установкой смесителя необходимо регулировочными кранами выровнять давление холодной и горячей воды при помощи вентилей регулирующих подачу воды в квартиру.

УКАЗАНИЯ ПО МОНТАЖУ











- / Перед монтажом следует проверить изделие на предмет повреждений при перевозке. После монтажа претензии о возмещении ущерба за повреждения при перевозке или повреждения поверхностей не принимаются.
- / Трубы и арматура должны быть установлены, промыты и проверены в соответствии с действующими нормами.
- / Необходимо соблюдать требования по монтажу, действующие в соответствующих странах.
- / Во время монтажа изделия квалифицированным персоналом поверхность крепления должна быть ровной по всей области крепления (не допускайте выступающих стыков или перекоса облицовочной плитки); для монтажа изделия следует использовать подходящую стену достаточной прочности.
- / При сверлении обратить внимание на проложенные трубы или электрический кабель!
- / Слив должен иметь достаточную производительность.

ТЕХНИЧЕСКИЕ ДАННЫЕ

Рабочее давление:	не более. 1 МПа
Рекомендуемое рабочее давление:	0,1 - 0,5 МПа
Давления:	1,6 МПа (1 МПа = 10 bar = 147 PSI)
Температура горячей воды:	не более. 70°C
Рекомендуемая темп. гор. воды:	65°C
Подключение:	G1/2 & G3/4
Расход при 0,3 МПа:	58 л/мин
10754180	не более. 70°C/4 мин
Термическая дезинфекция:	

- / укомплектован клапаном обратного тока воды
- / Изделие предназначено исключительно для питьевой воды!

ОПИСАНИЕ СИМВОЛОВ

-  Не применяйте силикон, содержащий уксусную кислоту.
-  РАЗМЕРЫ (см. стр. 17)
-  КОМПЛЕКТ (см. стр. 37)
-  ВАРИАНТЫ УСТАНОВКИ (см. стр. 18)
- Подогнать расположение модулей в соответствии с конструктивными параметрами.
-  Подключение воды DN20
- Теплая вода
-  Подключение воды DN20
- Холодная вода
-  СЕРЕДИНА ДУШЕВОЙ ВАННЫ
-  ОТКРОЙТЕ ВОДУ / ЗАКРОЙТЕ ВОДУ
-  НОСИТЕ ЗАЩИТНЫЕ ПЕРЧАТКИ
-  ПОРЯДОК МОНТАЖА
-  ЗАГЛУШИТЬ ОТХОДЯЩИЕ ЛИНИИ
- Ненужный выход необходимо уплотнить с помощью заглушки.
-  НАПОР ПРОВОДА
- Водопроводы для боковых душей прокладывают под наклоном.
-  НЕОБХОДИМО УСИЛЕНИЕ СТЕНЫ
- В этой области требуется укрепление стены.
-  ЗНАК ТЕХНИЧЕСКОГО КОНТРОЛЯ (см. стр. 17)

МОНТАЖ (см. стр. 32) 

▲ TURVALLISUUSOHJEET

- ▲ Asennuksessa on käytettävä käsiineitä puristumien ja viiltojen aiheuttamien tapaturmien estämiseksi.
- ▲ Tuotetta saa käyttää ainoastaan kylpy-, hygienia- ja puhdistustarkoituksiin.
- ▲ Lapset ja ruumiillisesti, henkisesti ja/tai aistillisesti rajoittuneet aikuiset eivät saa käyttää suihkujärjestelmää ilman valvontaa. Alkoholin tai huumeiden vaikutuksessa olevat henkilöt eivät saa käyttää suihkujärjestelmää.
- ▲ Suuret paine-erot kylmä- ja kuumavesiliitäntöjen välillä on tasattava.

ASENNUSOHJEET

- / Ennen asennusta on tarkastettava tuotteen mahdolliset kuljetusvahingot. Asennuksen jälkeen kuljetus- ja pintavaurioita ei hyväksytä.
- / Putket ja hana on asennettava, huuhdeltava ja tarkastettava voimassa olevien standardien mukaisesti.
- / Jokaisessa maassa on noudatettava siellä päteviä asennusohjeita.
- / Pätevän ammattihenkilöstön asentaessa tuotetta on otettava huomioon, että kiinnityspinnan on oltava koko kiinnitysalueelta tasainen (ei korkeita saumoja tai laattojen yhtymäkohtia), seinän rakenne soveltuu tuotteen asennukseen eikä siinä ole heikkoja kohtia.
- / Varo porattaessa sähkö- ja vesijohtoja!
- / Poisvirtausteho on mitoitettava riittävän suureksi.

TEKNISEET TIEDOT

Käyttöpaine:	maks. 1 MPa
Suosittelua käyttöpaine:	0,1 - 0,5 MPa
Koestuspaine:	1,6 MPa (1 MPa = 10 bar = 147 PSI)
Kuuman veden lämpötila:	maks. 70°C
Kuuman veden suosituslämpötila:	65°C
Liittimet:	G1/2 & G3/4
Läpivirtausmäärä 0,3 MPa paineella:	58 l/min
10754180	maks. 70°C/4 min
Lämpödesinfektio:	

- / Estää itsestään paluuvirtauksen
- / Tuote on suunniteltu käytettäväksi ainoastaan juomaveden kanssa!

MERKIN KUVAUS

-  Älä käytä etikkahappopitoista silikonia!
-  MITAT (katso sivu 17)
-  VARAOSAT (katso sivu 37)
-  ASENNUSESIMERKKEJÄ (katso sivu 18)
- Moduulin järjestys sovitetaan rakenteellisten vaatimusten mukaan.
-  Vesiliitäntä DN20
- Lämmin vesi
-  Vesiliitäntä DN20
- Kylmä vesi
-  SUIHKUALTAAN KESKUSTA
-  AVAA VEDENSYÖTTÖ / SULJE VEDENTULO
-  KÄYTÄ SUOJAKÄSIINEITÄ
-  ASENNUSJÄRJESTYS
-  POISTOKOHDAT TUKITAAN
- Käyttämätön lähtiin on suljettava sulikutulpalla.
-  PUTKIEN KALTEVUUS
- Vie sivusuuhkujen syöttöputket alaspäin laskevasti.
-  SEINÄN VAHVISTUS ON TARPEEN
- Tässä kohdassa seinää on vahvistettava
-  KOESTUSMERKKI (katso sivu 17)

ASENNUS (katso sivu 32) 

▲ SÄKERHETSANVISNINGAR

- ▲ Handskar ska bäras under monteringsarbetet så att man kan undvika kläm- och skärskadorgen werden.
- ▲ Produkten får bara användas till kroppshygien med bad och dusch.
- ▲ Barn samt vuxna med fysiska, psykiska eller sensoriska funktionshinder får inte använda produkten ensamma. Personer som är påverkade av alkohol- eller droger får inte använda produkten.
- ▲ Stora tryckskillnader mellan anslutningarna för varmt och kallt vatten måste utjämnas.

MONTERINGSANVISNINGAR

- / Det måste undersökas om produkten har transportskador innan den monteras. Efter monteringen accepteras inga transport- eller ytskiktsskador.
- / Ledningarna och blandaren måste monteras, spolats igenom och kontrolleras enligt de gällande normerna.
- / De installationsriktlinjer som gäller i länderna ska följas.
- / När kvalificerad fackpersonal monterar produkten är det viktigt att fästytan är plan över hela festsättningsområdet (inga fogar som sticker ut eller kakelförskjutning) och att väggstrukturen är lämplig för en montering av produkten och inte har några svaga punkter.
- / Tänk på elledning och vattenrör vid borrhull!
- / Tönningskapaciteten måste vara tillräcklig.

TEKNISKA DATA

Driftstryck:	max. 1 MPa
Rek. driftstryck:	0,1 - 0,5 MPa
Tryck vid provtryckning:	1,6 MPa (1 MPa = 10 bar = 147 PSI)
Varmvattentemperatur:	max. 70°C
Rek. varmvattentemp.:	65°C
Anslutningar:	G1/2 & G3/4
Flödeskapacitet vid 0,3 MPa: 10754180	58 l/min
Termisk desinfektion:	max. 70°C/4 min

- / Självspärr mot återflöde
- / Produkten är enbart avsedd för dricksvatten!

SYMBOLFÖRKLARING

-  Använd inte silikon som innehåller ättiksyra!
-  MÅTTEN (se sidan 17)
-  RESERVDLAR (se sidan 37)
-  MONTERINGSEXEMPEL (se sidan 18)
Anpassa modulernas placering till de förutsättningar som gäller på platsen.
-  Vattenanslutning DN20
-  Varmvatten
-  Vattenanslutning DN20
-  Kallvatten
-  MITTEN AV DUSCHKARET
-  SLÅ PÅ VATTEN / STÄNG AV VATTNET
-  BÄR SKYDDSHANDSKAR
-  MONTERINGSFÖLJD
-  PLUGGA IGEN AVLOPP
Det utlopp som inte behövs måste tätas med en blindstopp.
-  LEDNINGSFALL
Drag vattenledningar till sidoduschar med fall.
-  VÄGGFÖRSTÄRKNING NÖDVÄNDIG
Šioje zonoje būtinas sienos sutvirtinimas
-  TESTSIGILL (se sidan 17)

▲ SAUGUMO TECHNIKOS NURODYMAI

- ▲ Apsaugai nuo užspaudimo ir įsijojimo montavimo metu mūvėkite pirštines.
- ▲ Gaminys turi būti naudojamas tik maudymuisi, kūno higienai ir švarai palaikyti.
- ▲ Gaminį draudžiama naudotis vaikams, taip pat suaugusiems su fizine, dvasine negale ir (arba) sensorikos sutrikimais. Gaminį taip pat draudžiama naudotis asmenims, apsvaigusiems nuo alkoholio arba narkotikų.
- ▲ Turi būti išlyginti šalto ir karšto slėgio nelygumai.

MONTAVIMO INSTRUKCIJA

















- / Prieš montuojant būtina patikrinti, ar gaminys nebuvo pažeistas transportavimo metu. Sumontavus pretenzijos dėl transportavimo ir paviršiaus pažeidimų nepriimamos.
- / Vamzdžiai ir sujungimai turi būti montuojami, plaunami ir tikrinami pagal galiojančias normas.
- / Laikykitės atitinkamoje šalyje galiojančių direktyvų dėl įrengimo.
- / Atlikdami montavimo darbus, kvalifikuoti darbuotojai turi atkreipti dėmesį, kad pritvirtinimo plokštuma būtų lygi (be išsikišusių siūlių ar perkreiptų plytelių), sienų konstrukcija tikėtų gaminiui montuoti ir neturėtų jokių trūkumų.
- / Grežiant atkreipkite dėmesį į esamas elektros ir vandens linijas
- / Vandens nubėgimas privalo būti pakankamas.

TECHNINIAI DUOMENYS

Darbinis slėgis:	ne daugiau kaip 1 MPa
Rekomenduojamas slėgis:	0,1 - 0,5 MPa
Bandomasis slėgis:	1,6 MPa (1 MPa = 10 bar = 147 PSI)
Karšto vandens temperatūra:	ne daugiau kaip 70°C
Rekomenduojama karšto vandens temperatūra:	65°C
Prijungimas:	G1/2 & G3/4
Vandens pralaidumas, esant 0,3 MPa slėgiui:	10754180
Terminis dezinfekavimas:	58 l/min ne daugiau kaip 70°C/4 min

- / Su atbuliniu vožtuvu
- / Produktas skirtas tik geriamajam vandeniui!

SIMBOLIO APRAŠYMAS

-  Nenaudokite silikono, kurio sudėtyje yra acto rūgšties!
-  IŠMATAVIMAI (žr. psl. 17)
-  ATSARGINĖS DALYS (žr. psl. 37)
-  MONTAVIMO PAVYZDŽIAI (žr. psl. 18)
Modulių išdėstymas pritaikomas prie esamų techninių sąlygų.
-  Vandens prijungimas DN20
-  Šiltas vanduo
-  Vandens prijungimas DN20
-  Šaltas vanduo
-  DUŠO PADĖKLO CENTRAS
-  ĮJUNKITE VANDENS TIEKIMĄ / IŠJUNGTI VANDENS TIEKIMĄ
-  MŪVĖKITE APSAUGINES PIRŠTINES
-  MONTAVIMO EIGA
-  UŽKIMŠIMAS ATLIEKOMIS
Nenaudojamą išėjimą užaklinti.
-  SLĖGIS VAMZDYNE
Privesti vamzdžius šoniniams purkštukams.
-  BŪTINAS SIENOS SUTVIRTINIMAS
Šioje zonoje būtinas sienos sutvirtinimas
-  BANDYMO PAŽYMA (žr. psl. 17)

⚠ SIGURNOSNE UPUTE

- ⚠ Prilikom montaže se radi sprječavanja prignječenja i posjekotina moraju nositi rukavice.
- ⚠ Proizvod se smije primjenjivati samo za kupanje, tuširanje i osobnu higijenu.
- ⚠ Djeca, kao i tjelesno, mentalno i/ili senzorno hendikepirane odrasle osobe ne smiju se koristiti proizvodom bez nadzora. Osobe koje su pod utjecajem alkohola ili droga ne smiju se koristiti proizvodom.
- ⚠ Velika razlika u pritisku između vruće i hladne vode mora biti izbalansirana.

UPUTE ZA MONTAŽU

- / Prije montaže mora se provjeriti je li proizvod oštećen prilikom transporta. Nakon ugradnje se ne priznaju nikakve reklamacije koje se odnose na površinska i transportna oštećenja.
- / Cijevi i armatura moraju biti postavljeni, isprani i testirani prema važećim normama.
- / Obvezno se moraju uvažiti propisi o instalacijama koji vrijede u dotičnoj zemlji.
- / Kada proizvod montira kvalificirano stručno osoblje treba paziti da čitava površina na koju se učvršćuje bude ravna (bez istaknutih fuga ili krivljenja pločica), da je zidna konstrukcija primjerena montaži proizvoda te da nema slabih mjesta.
- / Prilikom bušenja treba paziti na strujne vodove i vodovodne cijevi!
- / Potreban je optimalan protok vode

TEHNIČKI PODATCI

Najveći dopušteni tlak:	tlak 1 MPa
Preporučeni tlak:	0,1 - 0,5 MPa
Probni tlak:	1,6 MPa (1 MPa = 10 bar = 147 PSI)
Temperatura vruće vode:	tlak 70°C
Preporučena temperatura vruće vode:	65°C
Spojevi:	G1/2 & G3/4
Protok vode uz tlak od 0,3 MPa:	58 l/min
10754180	tlak 70°C/4 min
Termička dezinfekcija:	

- / Funkcije samo-čišćenja
- / Proizvod je koncipiran isključivo za pitku vodu!

OPIS SIMBOLA

- Nemojte koristiti silikon koji sadrži octenu kiselinu!
- MJERE (pogledaj stranicu 17)
- REZERVNI DJELOVI (pogledaj stranicu 37)
- PRIMJERI INSTALACIJA (pogledaj stranicu 18)
Raspored modula prilagodite uvjetima koji vladaju na mjestu postavljanja.
- priključak na dovod vode DN20
- Topla voda
- priključak na dovod vode DN20
- Hladna voda
- SREDINA TUŠ-KADA
- OTVORITE DOTOK VODE / ZATVORITE VODU
- NOSITE ZAŠTITNE RUKAVICE
- REDOSLIJED MONTAŽNIH RADOVA
- ODČEPLJIVANJE OD VODA
Potrebno je ostaviti zatvoreni izlaz koji se ne koristi
- NAGIB CIJEVI
Položite vodovodne cijevi za bočni tuš s nagibom
- NEOPHODNO OJAČANJE ZIDA
U ovom je području potrebno ojačanje zida.
- OZNAKA TESTIRANJA (pogledaj stranicu 17)



⚠ GÜVENLİK UYARILARI

- ⚠ Montaj esnasında ezilme ve kesilme gibi yaralanmaları önlemek için eldiven kullanılmalıdır.
- ⚠ Ürün yalnızca banyo, hijyen ve beden temizliği amaçları doğrultusunda kullanılabilir.
- ⚠ Bedensel, ruhsal ve/veya sensörük engelli çocuk ve yetişkinler gözetimsiz olarak duş sistemini kullanmamalıdır. Alkol veya uyuşturucu etkisinde olanlar duş sistemini kullanmamalıdır.
- ⚠ Sıcak ve soğuk su bağlantıları arasında büyük basınç farklılıkları varsa, bu basınç farklılıklarının dengelenmesi gerekir.

MONTAJ AÇIKLAMALARI

- / Montaj işleminden önce ürün nakliye hasarları yönünden kontrol edilmelidir. Montaj işleminden sonra nakliye veya yüzey hasarları için sorumluluk üstlenilmemektedir.
- / Boruların ve armatürün montajı, yıkanması ve kontrolü geçerli normlara göre yapılmalıdır.
- / Ülkelerde geçerli kurulum yönetmeliklerine riayet edilmelidir.
- / Ürünün yetkili uzman personel tarafından montajı yapılırken, sabitleme yüzeyinin sabitleme planının tüm alanında bulunduğu (derz veya fayans kayması olmamalıdır), duvar yapısının ürünün montajı için uygun olduğuna ve zayıf noktaları bulunmadığına dikkat edilmelidir.
- / Delik açarken elektrik ve su hatlarına dikkat!
- / Çıkış kapasitesi yeterli miktarda boyutlandırılmış olmalıdır.

TEKNİK BİLGİLER

İşletme basıncı:	azami 1 MPa
Tavsiye edilen işletme basıncı:	0,1 - 0,5 MPa
Kontrol basıncı:	1,6 MPa (1 MPa = 10 bar = 147 PSI)
Sıcak su sıcaklığı:	azami 70°C
Tavsiye edilen su ısısı:	65°C
Bağlantılar:	G1/2 & G3/4
0,3 MPa'daki debi:	58 l/dak
10754180	azami 70°C/4 dak
Termik dezenfeksiyon:	

- / Geri emme önleyici
- / Ürün sadece şebeke suyu için tasarlanmıştır!

SİMGE AÇIKLAMASI

- Asetik asit içeren silikon kullanmayın!
- ÖLÇÜLERİ (bakınız sayfa 17)
- YEDEK PARÇALAR (bakınız sayfa 37)
- MONTAJ ÖRNEĞİ (bakınız sayfa 18)
Modüllerin düzenini yapı özelliklerine uyarlayın.
- Su bağlantısı DN20
- Sıcak su
- Su bağlantısı DN20
- Soğuk su
- DUŞ KÜVETİNİN ORTASI
- SUYU AÇIN / SUYU KESİN
- KORUYUCU EL DİVEN KULLANIN
- MONTAJ SIRASI
- ÇIKIŞLARI KAPATMA
Kullanılmayan çıkış bir kör tapayla izole edilmelidir.
- HAT EĞİMLERİ
Yan duşların su hatlarını eğimli şekilde döşeyin.
- DUVAR TAKVİYESİ GEREKLİDİR
Bu alanda duvarın kalınlaştırılması gereklidir.
- KONTROL İŞARETİ (bakınız sayfa 17)



Δ INSTRUȚIUNI DE SIGURANȚĂ

- Δ La montare utilizați mănuși pentru evitarea contuziunilor și tăierii mâinilor.
- Δ Produsul poate fi utilizat doar pentru spălarea, menținerea igienei și curățarea corpului.
- Δ Copiii și adulții cu dizabilități corporale, mintale și senzoriale nu pot utiliza sistemul de duș nesupravegheați. De asemenea este interzisă utilizarea sistemului de duș de către persoane, care se află sub influența alcoolului sau a drogurilor.
- Δ Diferențele de presiune mari între alimentarea cu apă rece și apă caldă trebuie echilibrate.

INSTRUȚIUNI DE MONTARE

- / Înainte de instalare verificați, dacă produsul prezintă deteriorări de transport. După instalare garanția nu acoperă deteriorările de transport și cele de suprafață.
- / Conductele și bateriile trebuie montate, spălate și verificate conform normelor în vigoare.
- / Respectați reglementările referitoare la instalare valabile în țara respectivă.
- / La montarea produsului de către un personal calificat se va avea grijă ca suprafața de fixare să fie plană pe toată aria de fixare (fără proeminențe ale rosturilor sau îmbinări între plăcile de faianță) și ca structura peretelui să fie corespunzătoare pentru fixarea produsului, să nu prezinte locuri cu rezistență redusă.
- / La efectuarea lucrărilor de găurire fiți atenți la conductele de apă și cablurile electrice!
- / Debitul de golire trebuie să fie suficient de mare.

DATE TEHNICE

Presiune de funcționare:	max. 1 MPa
Presiune de funcționare recomandată:	0,1 - 0,5 MPa
Presiune de verificare:	1,6 MPa (1 MPa = 10 bar = 147 PSI)
Temperatura apei calde:	max. 70°C
Temperatura recomandată a apei calde:	65°C
Racorduri:	G1/2 & G3/4
Debit de apă la 0,3 MPa:	58 l/min
10754180	max. 70°C / 4 min
Dezinfecție termică:	

- / Asigurat contra scurgere înapoi
- / Produsul este destinat exclusiv pentru apă potabilă.

DESCRIEREA SIMBOLURILOR

-  Nu utilizați silicon cu conținut de acid acetic!
-  DIMENSIUNI (vezi pag. 17)
-  PIESE DE SCHIMB (vezi pag. 37)
-  EXEMPLE DE MONTARE (vezi pag. 18)
-  Adaptați poziția modulelor condițiilor constructive.
-  Racord de apă DN20
-  Apă caldă
-  Racord de apă DN20
-  Apă rece
-  ÎN MIJLOCUL CĂZII DE DUȘ
-  SE INTRODUCĂ APA / OPRIȚI ALIMENTAREA CU APĂ
-  PURTAȚI MĂNUȘI DE PROTECȚIE
-  ORDINE DE MONTARE
-  ASTUPAȚI ORIFICIILE DE EVACUARE
-  Racordurile neutilizate trebuie acoperite cu dop etanș.
-  ÎNĂLȚIMEA DE SARCINĂ A CONDUCTEI
-  Montați conductele de apă înclinate (în cădere) pentru dușurile laterale.
-  ESTE NEVOIE DE CONSOLIDAREA PEREȚII.
-  În această zonă este nevoie de întărirea peretelui.
-  CERTIFICAT DE TESTARE (vezi pag. 17)

MONTARE (vezi pag. 32) 

Δ ΥΠΟΔΕΙΞΕΙΣ ΑΣΦΑΛΕΙΑΣ

- Δ Για να αποφύγετε τραυματισμούς κατά τη συναρμολόγηση πρέπει να φοράτε γάντια.
- Δ Το προϊόν επιτρέπεται να χρησιμοποιείται μόνο σαν μέσο λουτρού, υγιεινής και καθαρισμού του σώματος.
- Δ Παιδιά ή ενήλικες με μειωμένες σωματικές, διανοητικές και/ή αισθητήριες ανεπάρκειες δεν επιτρέπεται να χρησιμοποιούν το προϊόν χωρίς επιτήρηση. Άτομα υπό την επήρεια οινοπνεύματος ή ναρκωτικών δεν επιτρέπεται να χρησιμοποιούν σε καμία περίπτωση το προϊόν.
- Δ Οι διαφορές της πίεσης μεταξύ της σύνδεσης κρύου και ζεστού νερού θα πρέπει να αντισταθμίζονται.

ΟΔΗΓΙΕΣ ΣΥΝΑΡΜΟΛΟΓΗΣΗΣ



- / Πριν τη συναρμολόγηση πρέπει να εξεταστεί το προϊόν για ζημιές μεταφοράς. Μετά την εγκατάσταση δεν αναγνωρίζονται ζημιές από τη μεταφορά ή επιφανειακές ζημιές.
- / Οι σωλήνες και η μπαταρία πρέπει να τοποθετηθούν σύμφωνα με τα ισχύοντα πρότυπα, να τεθούν υπό πίεση και να δοκιμαστούν.
- / Θα πρέπει να τηρούνται οι οδηγίες εγκατάστασης που ισχύουν σε κάθε κράτος.
- / Κατά τη συναρμολόγηση του προϊόντος από ειδικό προσωπικό θα πρέπει να ελέγχεται με ιδιαίτερη προσοχή η επιφάνεια στερέωσης, αν είναι επίπεδη σε όλη της την επιφάνεια (δεν πρέπει να εξέχουν αρμοί ή πλακάκια), αν η υποδομή του τοίχου είναι κατάλληλη για τη στερέωση του προϊόντος και αν παρουσιάζει ασθενή σημεία.
- / Προσοχή όταν τρυπάτε πάνω από σωλήνες ηλεκτρικού ή νερού!
- / Η κατανάλωση νερού πρέπει να έχει επαρκείς διαστάσεις.

ΤΕΧΝΙΚΑ ΧΑΡΑΚΤΗΡΙΣΤΙΚΑ

Λειτουργία πίεσης:	έως 1 MPa
Συνιστώμενη λειτουργία πίεσης:	0,1 - 0,5 MPa
Πίεση ελέγχου:	1,6 MPa (1 MPa = 10 bar = 147 PSI)
Θερμοκρασία ζεστού νερού:	έως 70°C
Συνιστώμενη θερμοκρασία ζεστού νερού:	65°C
Συνδέσεις:	G1/2 & G3/4
Κατανάλωση νερού στα 0,3 MPa:	58 l/min
10754180	έως 70°C / 4 min
Θερμική απολύμανση:	

- / Περιλαμβάνει βαλβίδα αντεπιστροφής.
- / Το προϊόν έχει σχεδιαστεί αποκλειστικά για πόσιμο νερό!

ΠΕΡΙΓΡΑΦΗ ΣΥΜΒΟΛΩΝ

-  Μην χρησιμοποιείτε σιλικόνη που περιέχει οξικό οξύ!
-  ΔΙΑΣΤΑΣΕΙΣ (βλ. Σελίδα 17)
-  ΑΝΤΑΛΛΑΚΤΙΚΑ (βλ. Σελίδα 37)
-  ΠΑΡΑΔΕΙΓΜΑΤΑ ΣΥΝΑΡΜΟΛΟΓΗΣΗΣ (βλ. Σελίδα 18)
-  Προσαρμόστε τη διάταξη των στοιχείων στις επι τόπου συνθήκες
-  Παροχή νερού DN20
-  Ζεστό νερό
-  Παροχή νερού DN20
-  Κρύο νερό
-  ΜΕΣΟΝ ΤΗΣ ΝΤΟΥΣΙΕΡΑΣ
-  ΑΝΟΙΞΤΕ ΤΗΝ ΠΑΡΟΧΗ ΤΟΥ ΝΕΡΟΥ / ΚΛΕΙΣΤΕ ΤΗΝ ΠΑΡΟΧΗ ΝΕΡΟΥ
-  ΦΟΡΑΤΕ ΓΑΝΤΙΑ ΠΡΟΣΤΑΣΙΑΣ ΧΕΡΙΩΝ
-  ΣΕΙΡΑ ΕΡΓΑΣΙΩΝ ΣΥΝΑΡΜΟΛΟΓΗΣΗΣ
-  ΤΑΠΩΣΤΕ ΤΙΣ ΑΠΟΡΡΟΕΣ
-  Τα περιττά στόμια εξόδου πρέπει να στεγανοποιηθούν με ένα τυφλό πώμα.
-  ΚΛΙΣΗ ΣΩΛΗΝΑ
-  Εγκαταστήστε τους αγωγούς νερού του καταιονιστήρα σώματος με κλίση.
-  ΑΠΑΡΑΙΤΗΤΗ ΕΝΙΣΧΥΣΗ ΤΟΙΧΟΥ
-  Σε αυτήν την περιοχή είναι απαραίτητη μία ενίσχυση του τοίχου.
-  ΣΗΜΑ ΕΛΕΓΧΟΥ (βλ. Σελίδα 17)

ΣΥΝΑΡΜΟΛΟΓΗΣΗ (βλ. Σελίδα 32) 

VARNOSTNA OPOZORILA

- ⚠ Pri montaži je treba nositi rokavice, da se preprečijo poškodbe zaradi zmečkanja ali urezov.
- ⚠ Ta izdelek se sme uporabljati le z namenom umivanja, vzdrževanja higiene in telesne nege.
- ⚠ Otroci kot tudi odrasle osebe z omejenimi telesnimi, duševnimi in/ali senzoričnimi sposobnostmi ne smejo nenadzorovano uporabljati tega izdelka. Osebe, ki so pod vplivom alkohola ali drog, tega izdelka ne smejo uporabljati.
- ⚠ Velike razlike v tlaku med priključkom za mrzlo in priključkom za toplo vodo je potrebno izravnati.

NAVODILA ZA MONTAŽO

















- / Pred montažo je treba izdelek preveriti glede morebitnih transportnih poškodb. Po vgradnji transportne ali površinske poškodbe ne bodo več priznane.
- / Cevi in armaturo je treba montirati, izprati in preveriti po veljavnih standardih.
- / Upoštevati je treba pravilnike o inštalacijah, ki veljajo v posamezni državi.
- / Pri montaži tega proizvoda s strani kvalificiranega strokovnega osebja je treba paziti na to, da je pritrdilna ploskev na celotni površini za pritrditev gladka (brez izstopajočih fug ali zasekov ploščic), da je struktura stene primerna za montažo proizvoda in ne kaže šibkih mest.
- / Pri vrtnanju bodite pozorni na električne vodnike in vodovodno napeljavo
- / Zmogljivost odtoka mora biti ustrezne velikosti.

TEHNIČNI PODATKI

Delovni tlak:	maks. 1 MPa
Priporočeni delovni tlak:	0,1 - 0,5 MPa
Preskusni tlak:	1,6 MPa (1 MPa = 10 bar = 147 PSI)
Temperatura tople vode:	maks. 70°C
Priporočena temperatura tople vode:	65°C
Priključki:	G1/2 & G3/4
Pretok vode pri 0,3 MPa:	58 l/min
10754180	maks. 70°C/4 min
Termična dezinfekcija:	

- / Zaščita proti povratnemu toku
- / Proizvod je zasnovan izključno za sanitarno vodo!

OPIS SIMBOLA

-  Ne smete uporabiti silikona, ki vsebuje ocatno kislino!
-  MERE (glejte stran 17)
-  REZERVNI DELI (glejte stran 37)
-  PRIMERNI MONTAŽE (glejte stran 18)
Razporeditev modulov priagodite gradbenim okolišninam.
-  Vodni priključek DN20
-  Topla voda
-  Vodni priključek DN20
-  Mrzla voda
-  SREDINA PRŠNE KADI
-  ODPRITE VODO / ZAPRITE VODO.
-  NOSITE ZAŠČITNE ROKAVICE
-  MONTAŽNO ZAPOREDJE
-  ODMAŠITEV ODVODOV
Izhod, ki ga ne potrebujete, zatesnite s čepom.
-  NAGIB VODOVODA
Položite vodovodne cevi za stranske šobe z naklonom.
-  POTREBNO JE OJAČANJE STENE
V tem območju je potrebno ojačanje stene.
-  PRESKUSNI ZNAK (glejte stran 17)

MONTAŽA (glejte stran 32) **OHUTUSJUHISED**

- ⚠ Kandke paigaldamisel muljumis- ja löikevigastuste vältimiseks kindaid.
- ⚠ Toodet tohib kasutada ainult pesemis-, hügieeni- ja kehapihustamismärkidel.
- ⚠ Lapsed, samuti kehaliste, vaimsete või tajupiirangutega täiskasvanud ei tohi dušisüsteemi järelvalveta kasutada. Alkoholi või narkootikumide mõju all olevad isikud ei tohi dušisüsteemi kasutada.
- ⚠ Kui külma ja kuumu vee ühenduste surve on väga erinev, tuleb need tasakaalustada.



PAIGALDAMISJUHISED

- / Enne paigaldamist tuleb toodet kontrollida transpordikahjustuste osas. Pärast paigaldamist ei tunnustata enam transpordi- või pinnakahjustuste kaebuseid.
- / Voolikute ja segisti paigaldamisel, loputamisel ja kontrollimisel tuleb lähtuda kehtivatest normatiividest
- / Vastavas riigis kehtivaid paigalduseeskirju tuleb järgida.
- / Toote paigaldamisel kvalifitseeritud spetsialistide poolt tuleb jälgida, et kinnituspind oleks kogu ulatuses ühtlaselt tasane (mitte ühtki üleseisvat vuuki või kaldus kahhelkivi), seina ülesehitus toote paigaldamiseks sobiv ja ilma nõrkade kohtadeta.
- / Arvestage puurimisel voolukaablite ja veejuhtmete asukohaga
- / Äravoolu jõudlus peab olema piisav.

TEHNILISED ANDMED

Töörõhk	maks. 1 MPa
Soovitav tööõhk:	0,1 - 0,5 MPa
Kontrollsurve:	1,6 MPa (1 MPa = 10 baari = 147 PSI)
Kuuma vee temperatuur:	maks. 70°C
Soovitav kuuma vee temperatuur:	65°C
ühendused:	G1/2 & G3/4
Läbivool, kui rõhk on 0,3 MPa:	10754180
Termiline desinfektsioon:	58 l/min maks. 70°C/4 min
/ Tagasivooluklapp	
/ Toode on ette nähtud eranditult joogivee jaoks!	

SÜMBOLITE KIRJELDUS

-  Ärge kasutage äädikhapet sisaldavat silikoonil!
-  MÕÕTUDE (vt lk 17)
-  VARUOSAD (vt lk 37)
-  PAIGALDUSE NÄITED (vt lk 18)
Kohandage moodulite asendit paigaldusoludega sobivaks.
-  Veeühendus DN20
-  Soe vesi
-  Veeühendus DN20
-  Külma vesi
-  DUŠIVANNI KESE
-  KEERAKE VESI LAHTI / KEERAKE VESI KINNI
-  KANDKE KAITSEKINDAID
-  MONTAŽIJÄRJESTUS
-  SULGEGE ÄRAVOOLUAVAD
Mittevajalik väljavool tuleb sulgeda korgiga.
-  TORUSTIKU LANGUS
Paigaldage kehakuši jaoks vajalikud veetorud kaldega.
-  VAJALIK SEINATUGEVDUS
Selles alas tuleb seina tugevdada.
-  KONTROLLSERTIFIKAAT (vt lk 17)

PAIGALDAMINE (vt lk 32) 

△ DROŠĪBAS NORĀDES

- △ Montāžas laikā, lai izvairītos no saspiedumiem un iegriezumiem, nepieciešams nēsāt cimdus.
- △ Šo produktu drīkst izmantot tikai, lai mazgātos, higiēnai un ķermeņa tīrīšanai.
- △ Bērni, kā arī pieaugušie ar fiziskiem, garīgiem un/vai sensoriskiem ierobežojumiem nedrīkst lietot šo produktu bez uzraudzības. Personas, kas atrodas alkohola vai narkotisko vielu iespaidā, nedrīkst lietot šo dušas sistēmu.
- △ Jāizlīdzina spiediena atšķirības starp aukstā un karstā ūdens pievadiem.

NORĀDĪJUMI MONTĀŽAI

- / Pirms montāžas nepieciešams pārbaudīt, vai produktam transportēšanas laikā nav radušies bojājumi. Pēc iebūvēšanas bojājumi, kas radušies transportēšanas laikā, vai virsmas bojājumi netiek atzīti.
- / Cauruļvadi un armatūra ir jāuzstāda, jāizskalo un jāpārbauda saskaņā ar spēkā esošajiem standartiem.
- / Jāievēro attiecīgās valstīs spēkā esošās montāžas prasības.
- / Kvalificētiem speciālistiem, montējot produktu, jāpiegriež vērība tam, lai piestiprināšanas virsma visā piestiprināšanas zonā ir gluda (nav fūgu vai flīžu iecirtumu), sienas uzbūve ir piemērota produkta montāžai un tajā nav nestabilu vietu.
- / Urbjot pievērsiet uzmanību elektrības un ūdens vadiem!
- / Noplūdei jānodrošina pietiekama ūdens caurplūde.

TEHNISKIE DATI

Darba spiediens:	maks. 1 MPa
Ieteicamais darba spiediens:	0,1 - 0,5 MPa
Pārbaudes spiediens:	1,6 MPa (1 MPa = 10 bar = 147 PSI)
Karstā ūdens temperatūra:	maks. 70°C
Ieteicamā karstā ūdens temperatūra:	65°C
Pieslēgumi:	G1/2 & G3/4
Caurteces intensitāte pie 0,3 MPa:	58 l/min
10754180	
Termiskā dezinfekcija:	maks. 70°C / 4 min

- / Drošības vārsts
- / Izstrādājums ir paredzēts tikai dzeramajam ūdenim!

SIMBOLU NOZĪME

-  Neizmantojot silikonu, kas satur etiķskābi!
-  IZMĒRUS (skat. lpp. 17)
-  REZERVES DAĻAS (skat. lpp. 37)
-  MONTĀŽAS PIEMĒRI (skat. lpp. 18)
Moduļu izkārtojumu pielāgojiet ēkas apstākļiem.
-  Ūdensvada pieslēgvietā DN20
Siltais ūdens
-  Ūdensvada pieslēgvietā DN20
Aukstais ūdens
-  DUŠAS PALIKTŅA VIDUS
-  ATGRIEZIET ŪDENI / NOSLĒGT ŪDENI
-  VALKĀT AIZSARGCIMDUS
-  MONTĀŽAS SECĪBA
-  NOSLĒDZIET ATVERES
Neizmantojiet izteku aizbāzīt ar aizbāzni.
-  CAURULES KRITUMS
Montēt ūdens cauruļvadu sānu (ķermeņa) dušām ar atbilstošu slīpumu.
-  NEPIECIEŠAMA SIENAS STIPRINĀŠANA
Šajā zonā ir nepieciešams pastiprināt sienu.
-  PĀRBAUDES ZĪME (skat. lpp. 17)

MONTĀŽA (skat. lpp. 32) 

△ SIGURNOSNE NAPOMENE

- △ Prilikom montaže se radi sprečavanja prignječenja i posekotina moraju nositi rukavice.
- △ Proizvod sme da se koristi samo za kupanje, tuširanje i ličnu higijenu.
- △ Deca, kao i telesno, mentalno i/ili senzorno hendikepirane odrasle osobe ne smeju da koriste proizvod bez nadzora. Osobe koje su pod uticajem alkohola ili droga ne smeju da koriste proizvod.
- △ Velika razlika u pritisku između vruće i hladne vode mora biti izbalansirana.

INSTRUKCIJE ZA MONTAŽU





- / Pre montaže se mora proveriti da li je proizvod oštećen pri transportu. Nakon ugradnje se ne priznaju nikakve reklamacije koje se odnose na površinska i transportna oštećenja.
- / Vodovi i armatura moraju biti postavljeni, isprani i testirani prema važećim normama.
- / Treba se pridržavati propisa koji u određenim zemljama važe za instalacije.
- / Kada proizvod montira kvalifikovano stručno osoblje treba paziti da čitava površina na koju se učvršćuje bude ravna (bez istaknutih fuga ili krivljenja pločica), da je zidna konstrukcija primerena montaži proizvoda i da nema slabih mesta.
- / Prilikom bušenja treba paziti na električne kablove i vodovodne cevi!
- / Mora se predvideti dovoljan kapacitet odvoda.

TEHNIČKI PODACI

Radni pritisak:	maks. 1 MPa
Preporučeni radni pritisak:	0,1 - 0,5 MPa
Probni pritisak:	1,6 MPa (1 MPa = 10 bar = 147 PSI)
Temperatura vruće vode:	maks. 70°C
Preporučena temperatura vruće vode:	65°C
Priključci:	G1/2 & G3/4
Protok vode pri pritisku od 0,3 MPa:	58 l/min
10754180	
Termička dezinfekcija:	maks. 70°C / 4 min

- / Zaštita od povratnog toka
- / Proizvod je koncipiran isključivo za pijaću vodu!

OPIS SIMBOLA

-  Nemojte koristiti silikon koji sadrži sirćetnu kiselinu!
-  MERE (vidi stranu 17)
-  REZERVNI DELOVI (vidi stranu 37)
-  PRIMERI MONTAŽE (vidi stranu 18)
Raspored modula prilagodite građevinskim uslovima na mestu postavljanja.
-  priključak za vodu DN20
Topla voda
-  priključak za vodu DN20
Hladna voda
-  SREDINA TUŠ-KADA
-  OTVORITE DOTOK VODE / ZATVORITE DOTOK VODE
-  NOSITE ZAŠTITNE RUKAVICE
-  REDOSLED MONTAŽNIH RADOVA
-  ODČEPLJIVANJE ODVODA
Izlaz koji se ne koristi, mora se zatvoriti slepim čepom.
-  NAGIB CEVI
Položite vodovodne cevi za bočni tuš s nagibom.
-  NEOPHODNO OJAČANJE ZIDA
U ovoj oblasti je potrebno ojačanje zida.
-  ISPITNI ZNAK (vidi stranu 17)

MONTAŽA (vidi stranu 32) 

△ SIKKERHETSHENVISNINGER

- △ Bruk hansker under montasjen for å unngå klem- og kuttskader.
- △ Produktet skal kun brukes for bade-, hygiene- og kroppshygiene.
- △ Barn og voksne med fysiske og psykiske og/eller sensoriske handicap skal ikke bruke dusjsystemet uten oppsyn. Personer som er påvirket av alkohol eller narkotika skal ikke bruke dusjsystemet.
- △ Store trykkdifferanser mellom kaldt- og varmtvannstilkoblinger skal utlignes.

MONTAGEHENVISNINGER

- / Før montasjen skal produktet sjekkes for transportskader. Etter monteringen aksepteres ikke noen transport- eller overflateskader.
- / Ledningene og armaturen skal monteres, spyles og sjekkes iht. de gyldige normer.
- / Gjeldende retningslinjer for rørleggerarbeid i de enkelte land skal følges.
- / Under monteringen av produktet gjort av kvalifisert fagpersonell, skal man påse at monteringsoverflaten på hele festeområdet er plant (ingen utstikkende fuger eller flisekanter), at veggoppbyggingen egner seg for produktmontasjen og ikke viser svake punkter.
- / Ved boring skal det passes på strøm- og vannledninger!
- / Utløpsytelsen skal være tilstrekkelig dimensjonert.

TEKNISKE DATA

Driftstrykk	maks. 1 MPa
Anbefalt driftstrykk:	0,1 - 0,5 MPa
Prøvetrykk	1,6 MPa
	(1 MPa = 10 bar = 147 PSI)
Varmtvannstemperatur	maks. 70°C
Anbefalt temperatur for varmt vann	65°C
Tilkoblinger:	G1/2 & G3/4
Gjennomstrømningsytelse ved 0,3 MPa:	58 l/min
10754180	
Termisk desinfisering:	maks. 70°C / 4 min
/ Egensikker mot tilbakeflyt	
/ Produktet er utelukkende designet for drikkevann!	

SYMBOLBESKRIVELSE

-  Ikke bruk silikon som inneholder eddiksyre!
-  MÅL (se side 17)
-  SERVICEDELER (se side 37)
-  MONTASJE- EKSEMPEL (se side 18)
Modulenes anordning tilpasses omstendighetene
-  Vanntilkobling DN20
-  Varmtvann
-  Vanntilkobling DN20
-  Kaldtvann
-  MIDTEN PÅ DUSJKAR
-  VANN SETTES PÅ / SLÅ AV VANN
-  BRUK VERNEHANSKER
-  MONTASJE REKKEFØLGE
-  STOPPE TIL AVGANGER
Utgangen som ikke brukes kan tettes med en blindplugg.
-  LEDNINGSFALL
Vannledninger for sidedusjer installeres med fall.
-  VEGGFORSTERKNING ER NØDVENDIG
I dette området skal veggen forsterkes.
-  PRØVEMERKE (se side 17)

△ УКАЗАНИЯ ЗА БЕЗОПАСНОСТ

- △ При монтажа трябва да се носят ръкавици, за да се избегнат наранявания поради притискане или порязване.
- △ Позволено е използването на продукта само за къпане, хигиена и цели на почистване на тялото.
- △ Не е позволено деца, както и възрастни с физически, умствени и/или сензорни ограничения да използват продукта без надзор. Не е позволено използването на системата на продукта от лица, употребили алкохол или дрога.
- △ Големите разлики в налягането между изводите за студената и топлата вода трябва да се изравняват.

УКАЗАНИЯ ЗА МОНТАЖ

















- / Преди монтажа продуктът трябва да се провери за транспортни щети. След монтажа не се признават транспортни или повърхностни щети.
- / Тръбопроводите и арматурата трябва да се монтират, промият и проверят в съответствие с валидните норми.
- / Трябва да бъдат спазвани валидните в съответните страни предписания за инсталиране.
- / При монтаж на продукта от квалифицирани специалисти да се внимава за това, закрепващата повърхност в целия диапазон на закрепването да бъде равна (без изпъкнали fugи или изместване на плочки), конструкцията на стената да е подходяща за монтаж на продукта и да няма слаби места.
- / При пробиването внимавайте за електро- и водопроводите!
- / Трябва да се изчисли достатъчна мощност на изтичане.

ТЕХНИЧЕСКИ ДАННИ

Работно налягане:	макс. 1 MPa
Препоръчително работно налягане:	0,1 - 0,5 MPa
Контролно налягане:	1,6 MPa
	(1 MPa = 10 bar = 147 PSI)
Температура на горещата вода:	макс. 70°C
Препоръчителна температура на горещата вода:	65°C
Изводи:	G1/2 & G3/4
Мощност на потока при 0,3 MPa:	58 л/мин
10754180	
Термична дезинфекция:	макс. 70°C / 4 мин

- / Самозащитен против обратно изтичане
- / Продуктът е разработен само за питейна вода!

ОПИСАНИЕ НА СИМВОЛИТЕ

-  Не използвайте силикон, съдържащ оцетна киселина!
-  РАЗМЕРИ (вижте стр. 17)
-  СЕРВИЗНИ ЧАСТИ (вижте стр. 37)
-  ПРИМЕРИ ЗА МОНТАЖ (вижте стр. 18)
Подреждането на модулите се изпълнява в съответствие с конструктивните дадености.
-  Извод за вода DN20
-  Топла вода
-  Извод за вода DN20
-  Студена вода
-  СРЕДА НА КОРИТОТО НА ДУШ-КАБИНАТА
-  ВКЛЮЧВАНЕ НА ВОДАТА / ИЗКЛЮЧВАНЕ НА ВОДАТА
-  НОСЕТЕ ЗАЩИТНИ РЪКАВИЦИ
-  ПОСЛЕДОВАТЕЛНОСТ НА МОНТАЖА
-  ЗАТАПВАНЕ НА ИЗВОДИТЕ
Излишният извод може да се уплътни с глуха пробка.
-  НАКЛОН НА ТРЪБОПРОВОДА
Водопроводните линии за страничните разпръскватели полагайте с наклон.
-  НЕОБХОДИМО Е УСИЛВАНЕ НА СТЕНАТА
В тази област е необходимо подсилване на стената.
-  КОНТРОЛЕН ЗНАК (вижте стр. 17)

△ UDHËZIME SIGURIE

- △ Për të evituar lëndimet e pickimeve ose të prerjeve gjatë procesit të montimit duhet që të vishni doreza.
- △ Produkti duhet të përdoret vetëm qëllimet e banjave, të higjienës dhe të larjes së trupit.
- △ Fëmijët dhe të rriturit me aftësi të kufizuara fizike, mendore dhe/ose ndijuese nuk duhet ta përdorin produktin pa qenë nën mbikëqyrje. Personat që janë nën ndikimin e drogave ose të alkoolit nuk duhet ta përdorin produktin.
- △ Ndryshimet e mëdha të presionit mes lidhjeve të ujit të ftohtë dhe atij të ngrohtë duhen ekuilibruar.

UDHËZIME PËR MONTIMIN

- / Përpara montimit duhet që produkti të kontrollohet për dëmtime nga transporti. Pas instalimit nuk do të njihet asnjë dëmtim nga transporti ose dëmtim i sipërfaqes.
- / Tubacionet dhe rubinetet duhet që të montohen, të shpëlahen dhe të kontrollohen sipas standardeve në fuqi
- / Duhet të respektohen linjat udhëzuese të instalimit, të vlefshme për vendet respektive.
- / Gjatë montimit të produktit nga teknikët e specializuar duhet mbajtur parasysh që sipërfaqja e montimit gjendet brenda zonës së përgjithshme të planit të montimit (nuk ka vendbashkime të dala ose mospërputhje të pllakave), që struktura e murit është e përshtatshme për montimin e produktit dhe që nuk paraqet asnjë pikë të dobët.
- / Gjatë shpimit bëni kujdes për të gjitha linjat elektrike dhe tubacionet e ujit
- / Kapaciteti i rrjedhjes duhet dimensionuar në mënyrë të mjaftueshme.

TË DHËNA TEKNIKE

Presioni gjatë punës	maks. 1 MPa
Presioni i rekomanduar:	0,1 - 0,5 MPa
Presioni për provë:	1,6 MPa (1 MPa = 10 bar = 147 PSI)
Temperatura e ujit të ngrohtë	maks. 70°C
Temperatura e rekomanduar e ujit të ngrohtë:	65°C
Lidhjet:	G1/2 & G3/4
Kapaciteti i rrjedhjes në 0,3 MPa:	10754180 58 l/min
Dezinfektim Termik:	maks. 70°C/4 min

- / Siguresa kundër rrjedhjes në drejtim të kundërt
- / Produkti është projektuar ekskluzivisht për ujë të pijshëm!

PËRSHKRIMI I SIMBOLIT

 Mos përdorni silikon që në përbërje ka acid acetik.

 PËRMASAT (shih faqen 17)

 PJESËT E SERVISIT (shih faqen 37)

 SHEMBUJ TË MONTIMIT (shih faqen 18)
Përshtateni vendosjen e modulit sipas kushteve të ndërtimit.

 Lidhja me rrjetin e ujit DN20

 Uji i ngrohtë

 Lidhja me rrjetin e ujit DN20

 Uji i ftohtë

 MESI I VASKËS SË DUSHIT

 HAPNI UJIN / MBYLLNI UJIN.

 VENDOSNI DOREZA MBROJTËSE

 RADHA E MONTIMIT

 BLOKIMI I DALJEVE

Dalja që nuk nevojitet duhet izoluar me tapë qorre.

 PENDENCA E TUBACIONIT
Vendosni tubacionet e ujit për spërkatëset anësore me pjerrësi.

 NEVOJITET PËRFORCIMI I MURIT
Në këtë zonë është e nevojshëm një përforcim i murit.

 SHENJA E KONTROLLIT (shih faqen 17)

MONTIMI (shih faqen 32)



△ تنبيهات الأمان

- △ يجب ارتداء قفازات لليد أثناء التركيب لتجنب حدوث أضرار الإحتشاش أو الجروح.
- △ لا يجب استخدام المنتج إلا في أغراض الاستحمام والأغراض الصحية وأغراض تنظيف الجسم.
- △ لا يسمح لأي أطفال أو أفراد بالغين يعانون من إعاقات بدنية أو ذهنية أو حسية أو يعانون من جميع هذه الإعاقات باستخدام المنتج إلا تحت إشراف آخرين. كما أنه لا يسمح لأي شخص تحت تأثير تناول الكحول أو المخدرات باستخدام نظام الدش.
- △ يجب أن يكون تيار الماء الساخن والماء البارد متعادلين في الضغط.

تعليمات التركيب

- / قبل القيام بعملية التركيب، يجب فحص المنتج للتأكد من خلوه من أية تلفيات ناتجة عن النقل. بعد القيام بعملية التركيب، لن يتم الاعتراف بوجود أية تلفيات سطحية أو تلفيات ناتجة عن عملية النقل.
- / يجب تركيب وغسيل واختبار التوصيلات وخلطات المياه طبقاً للمعايير السارية.
- / يجب مراعاة القواعد الخاصة بالتركيب وأعمال السباكة وفقاً للوائح الخاصة بكل بلد.
- / عند التركيب بواسطة عمال تركيب متخصصين يجب الإنتباه إلى أن مساحة التثبيت في مكان التركيب بوجه عام مسطحة (لا توجد روابط أو فروق للربط بين البلاطات). لذا يجب التأكد من أن الحائط الذي سيتم تركيب المنتج عليه صالح لذلك وأنه لا يوجد به نقاط ضعف.
- / يجب الحذر عند التقب فوق وصلات كهرياء أو مياه!
- / يجب أن يكون الأداء من حيث حجز الفضلات ذا حجم مناسب.

المواصفات الفنية

الحد الأقصى 1 ميجاباسكال	ضغط التشغيل:
0,5 - 0,1 ميجاباسكال	ضغط التشغيل الموصى به:
1,6 ميجاباسكال	ضغط الاختبار:
(1 ميجاباسكال = 10 بار = 147 PSI)	درجة حرارة الماء الساخن:
الحد الأقصى 70°C	درجة الحرارة الموصى بها للماء الساخن:
65°C	التوصيلات:
G1/2 & G3/4	معدل التدفق عند ضغط 0,3 ميجاباسكال:
58 لتر / الدقيقة	10754180
الحد الأقصى 70°C / 4 الدقيقة	تعقيم حراري:
	/ خاصية عدم التدفق العكسي
	/ المنتج مخصص فقط لماء الشرب!

وصف الرمز

- هام! لا تستخدم السليكون الذي يحتوي على أحماض!
- أبعاد (راجع صفحة 17)
- قطع الغيار (راجع صفحة 37)
- مثال على التركيب (راجع صفحة 18)
- يجب ضبط ترتيب الأنظمة حسب معطيات البناء
- توصيلة مياه DN20
- ماء دافئ
- توصيلة مياه DN20
- ماء بارد
- بانيو مزود بدش في المنتصف
- افتح خلط الماء. / قم بإيقاف المياه
- يجب ارتداء قفازات الحماية
- ترتيب التركيب
- س المخارج
- قم بسد المنفذ غير المستخدم.
- مهبط توصيلة
- قم بتركيب مواسير المياه للدش العادي المنحدر.
- المنطقة الخاصة بالدعم المطلوب للجدار
- يلزم هذا في النطاق وجود تقوية للحائط.
- شهادة اختبار (راجع صفحة 17)

التركيب (راجع صفحة 32)



▲ BIZTONSÁGI UTASÍTÁSOK

- ▲ A szerelésnél a zúzódások és vágási sérülések elkerülése érdekében kesztyűt kell viselni.
- ▲ A terméket csak fürdéshez, mosakodáshoz, és egészségügyi tisztálkodáshoz szabad használni.
- ▲ Gyermekek, valamint testileg, szellemileg fogyatékos és/vagy érzékelésben korlátozott személyek nem használhatják felügyelet nélkül a terméket. Alkohol és kábítószer befolyása alatt álló személyek nem használhatják a terméket.
- ▲ A hidegvíz- és a melegvíz-csatlakozások közötti nagy nyomáskülönbséget kikell egyenlíteni!

SZERELÉSI UTASÍTÁSOK

















- / A szerelés előtt ellenőrizni kell, hogy a terméknek nincs-e szállítási sérülése. Beépítés után a szállítási- vagy felületi sérüléseket nem ismerik el.
- / A vezetékeket és a csaptelepet az érvényes szabványoknak megfelelően kell felszerelni, öblíteni és ellenőrizni
- / Az egyes országokban érvényes installációs irányelveket be kell tartani.
- / A termék képzett szakember általi felszerelése esetén ügyelni kell arra, hogy a rögzítési felület teljesen sima legyen (ne legyen kiálló fuga vagy csempe), a fal szerkezete a termék felszerelésére alkalmas legyen, és ne legyen gyenge pontja.
- / Fúrás esetén ügyelni kell az áram- és vízvezetékekre!
- / A kifolyási teljesítményt megfelelően kell dimenzionálni.

MŰSZAKI ADATOK

Üzemi nyomás:	max. 1 MPa
Ajánlott üzemi nyomás:	0,1 - 0,5 MPa
Nyomáspróba:	1,6 MPa
	(1 MPa = 10 bar = 147 PSI)
Forróvíz hőmérséklet:	max. 70°C
Forróvíz javasolt hőmérséklete:	65°C
Csatlakozás:	G1/2 & G3/4
Átfolyási teljesítmény 0,3 MPa:	
10754180	58 l/perc
Termikus fertőtlenítés:	max. 70°C/4 perc

- / Visszafolyás gátlóval
- / A terméket kizárólag ivóvízhez tervezték!

SZIMBÓLUMOK LEÍRÁSA

-  Ne használjon ecetsavtartalmú szilikon!
-  M É R E T E T (lásd a oldalon 17)
-  TARTOZÉKOK (lásd a oldalon 37)
-  SZERELÉSI PÉLDÁK (lásd a oldalon 18)
A modulok elrendezését az építési adottságokhoz kell igazítani.
-  Vízcsatlakozás DN20
-  Melegvíz
-  Vízcsatlakozás DN20
-  Hidegvíz
-  ZUHANYTÁLCA KÖZEPE
-  NYISSUK MEG A VIZET. / ZÁRJUK EL A VIZET
-  VISELJEN VÉDKESZTYŰT
-  SZERELÉSI SORREND
-  KIMENETEKET LEZÁRNI
A fölösleges kimenetet vakdugóval kell lezárni.
-  VEZETÉK ESÉSE
Az oldalzuhanyokhoz a vízvezetékét lejtéssel ajánlott beszerelni.
-  SZÜKSÉGES A FAL MEGERŐSÍTÉSE
Ezen a területen a fal megerősítésére van szükség.
-  VIZSGAJEL (lásd a oldalon 17)



AXOR ShowerCollection
10754180

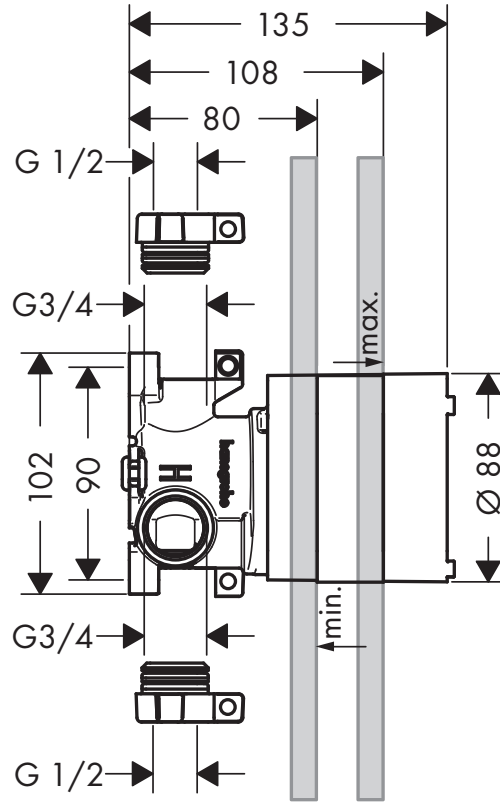
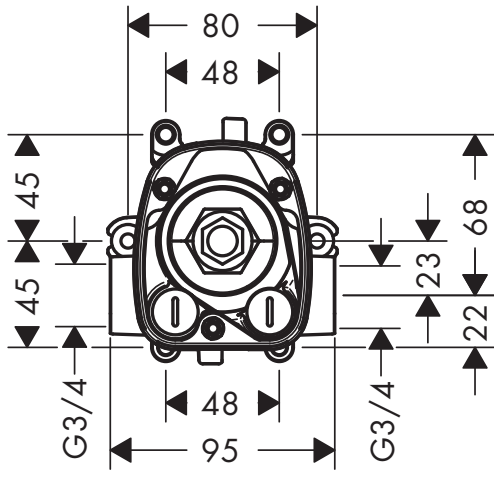

P-IX

DVGW

SVGW

ACS

WRAS

ETA

KIWA



10754180

X

X

X

1401

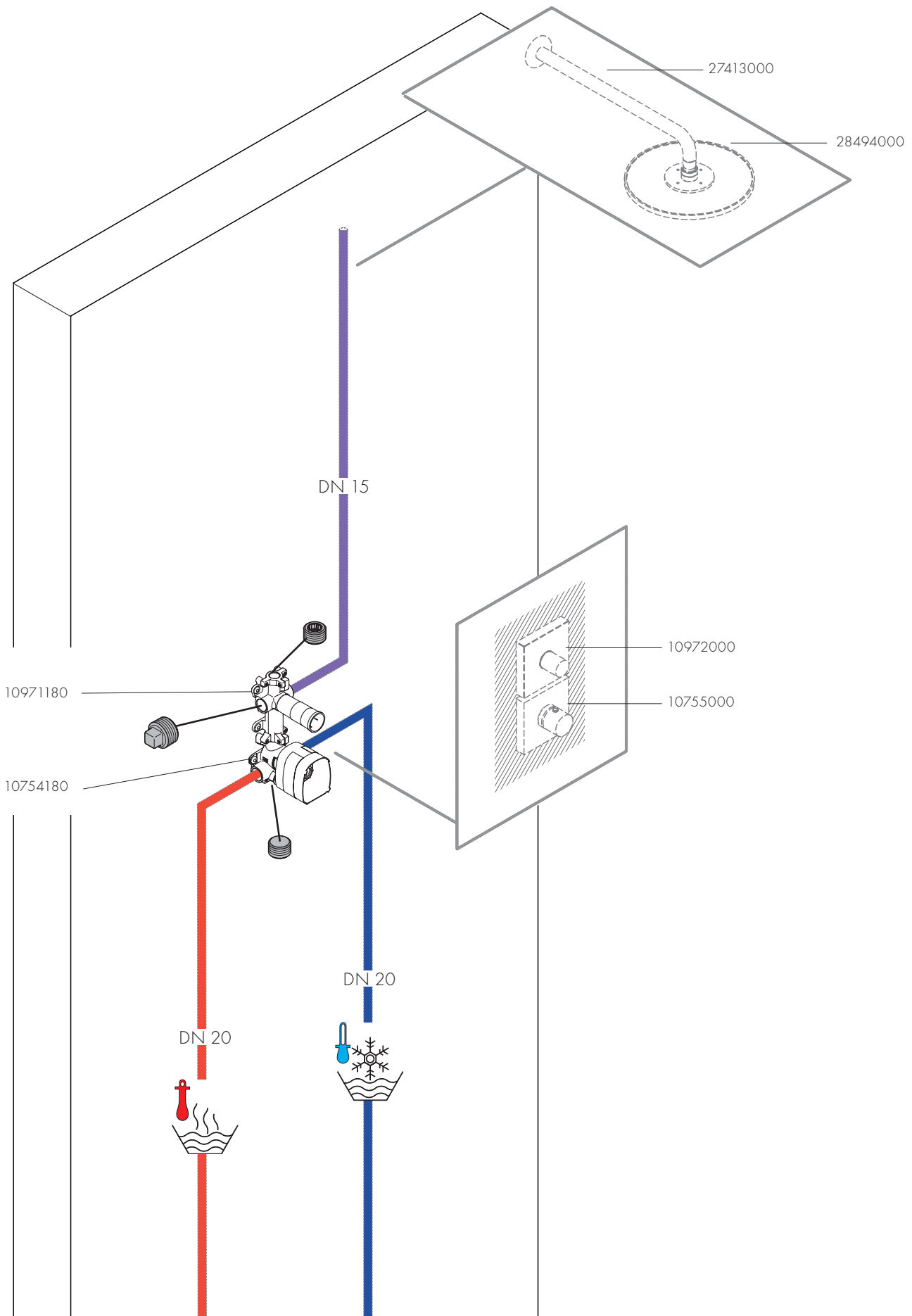

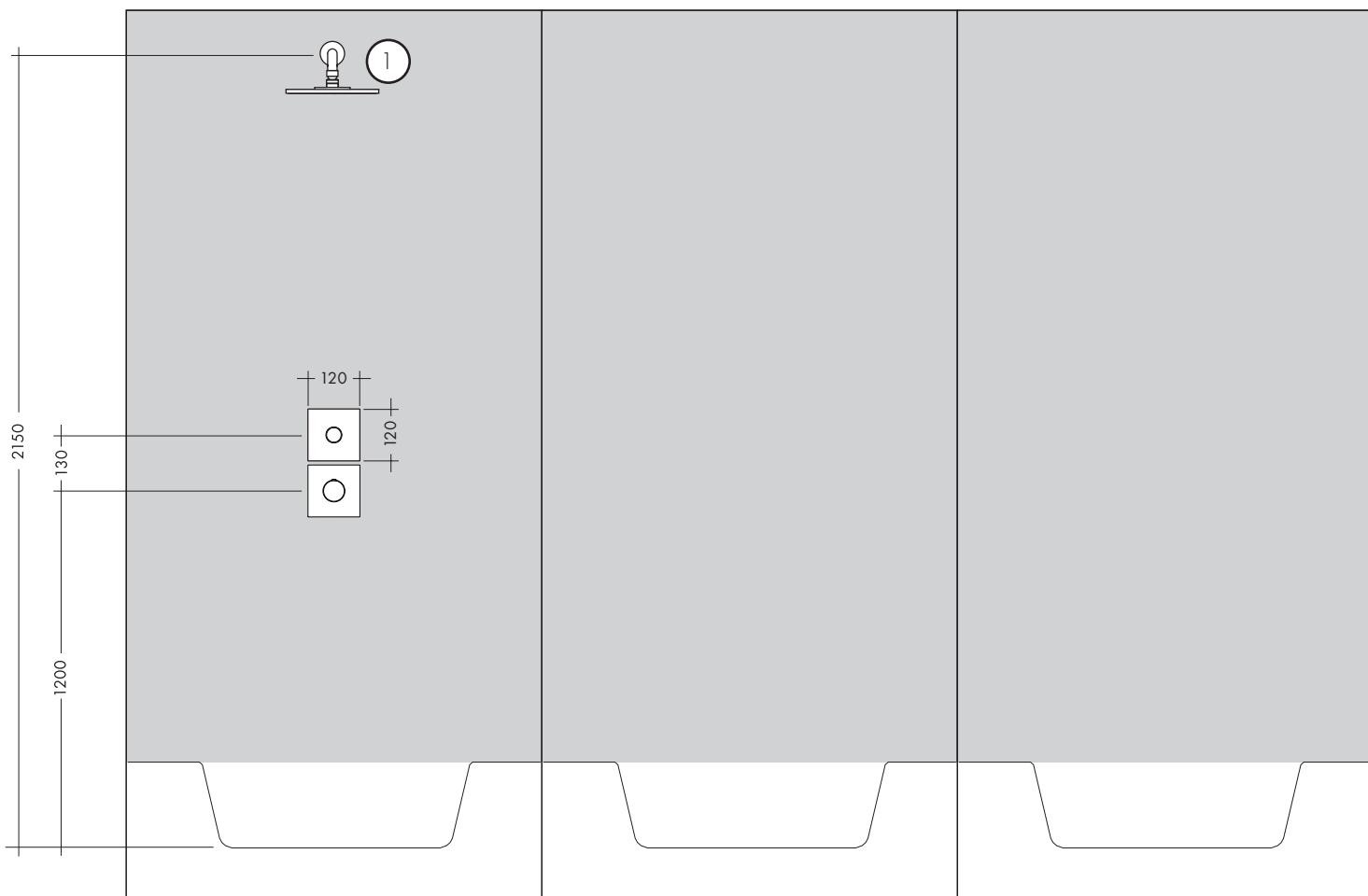
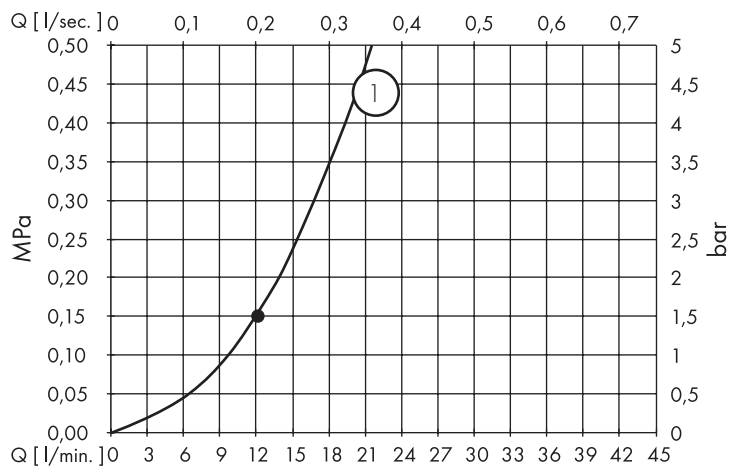

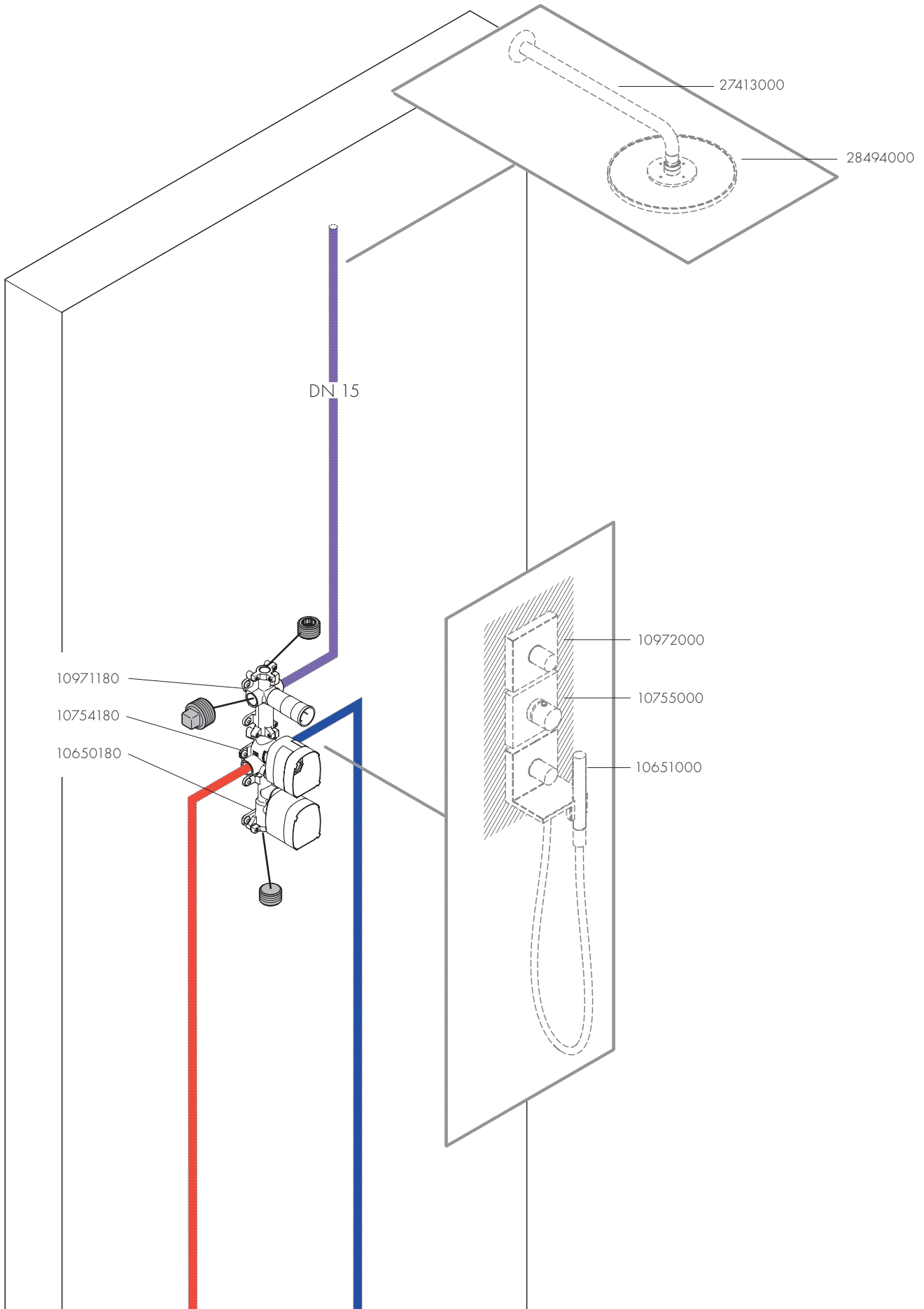

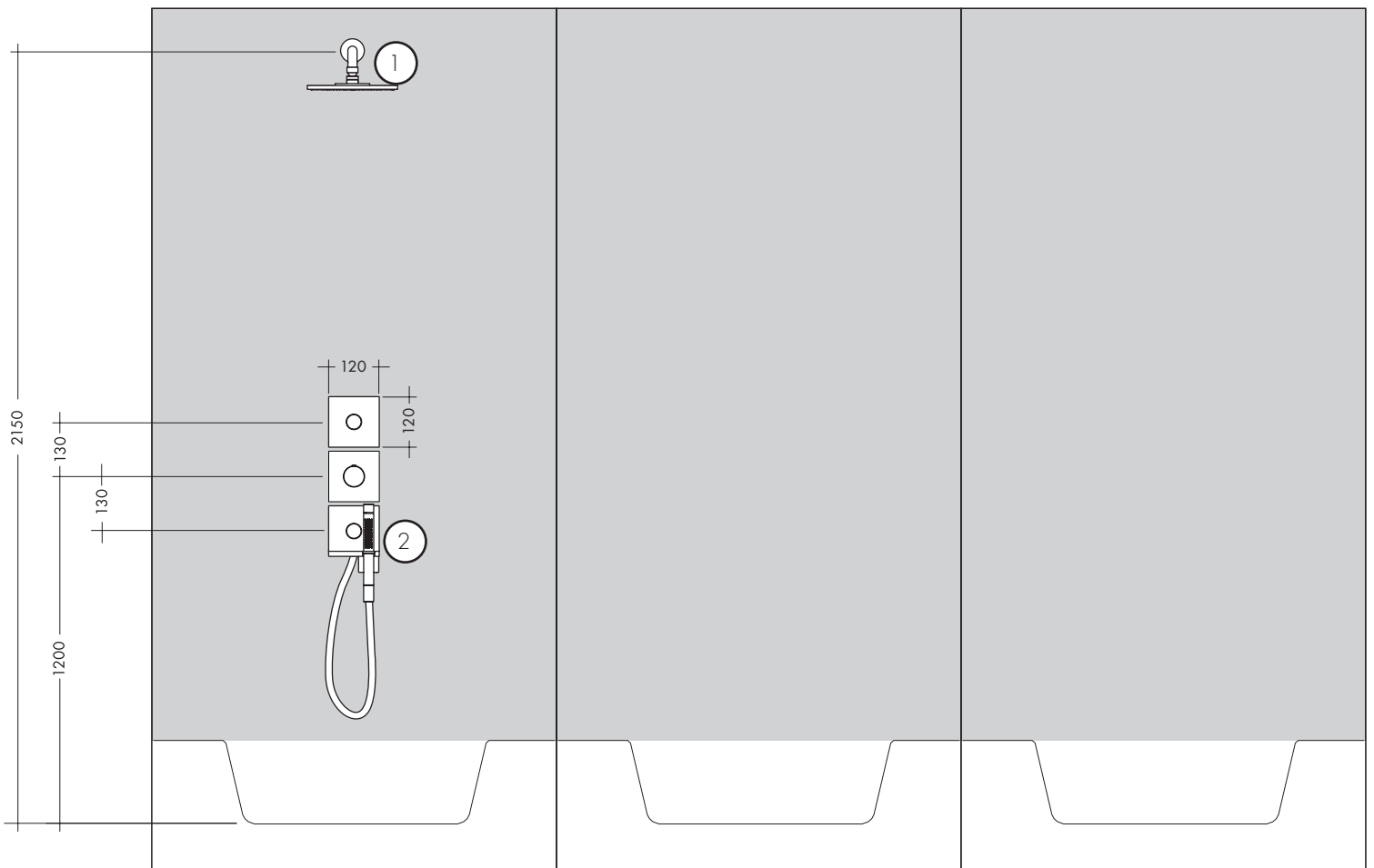
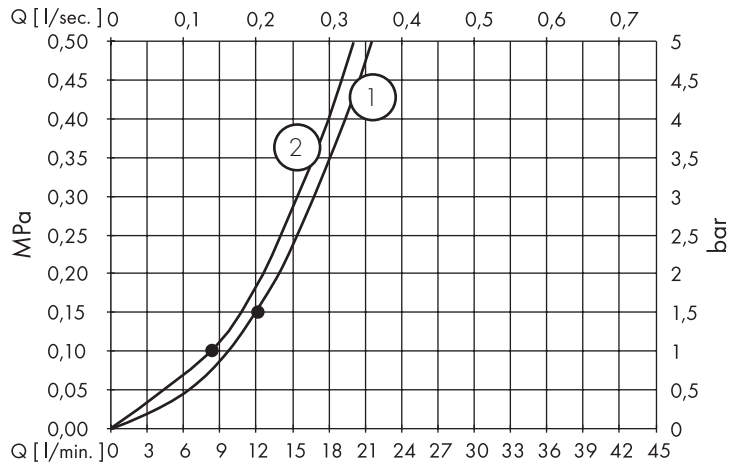

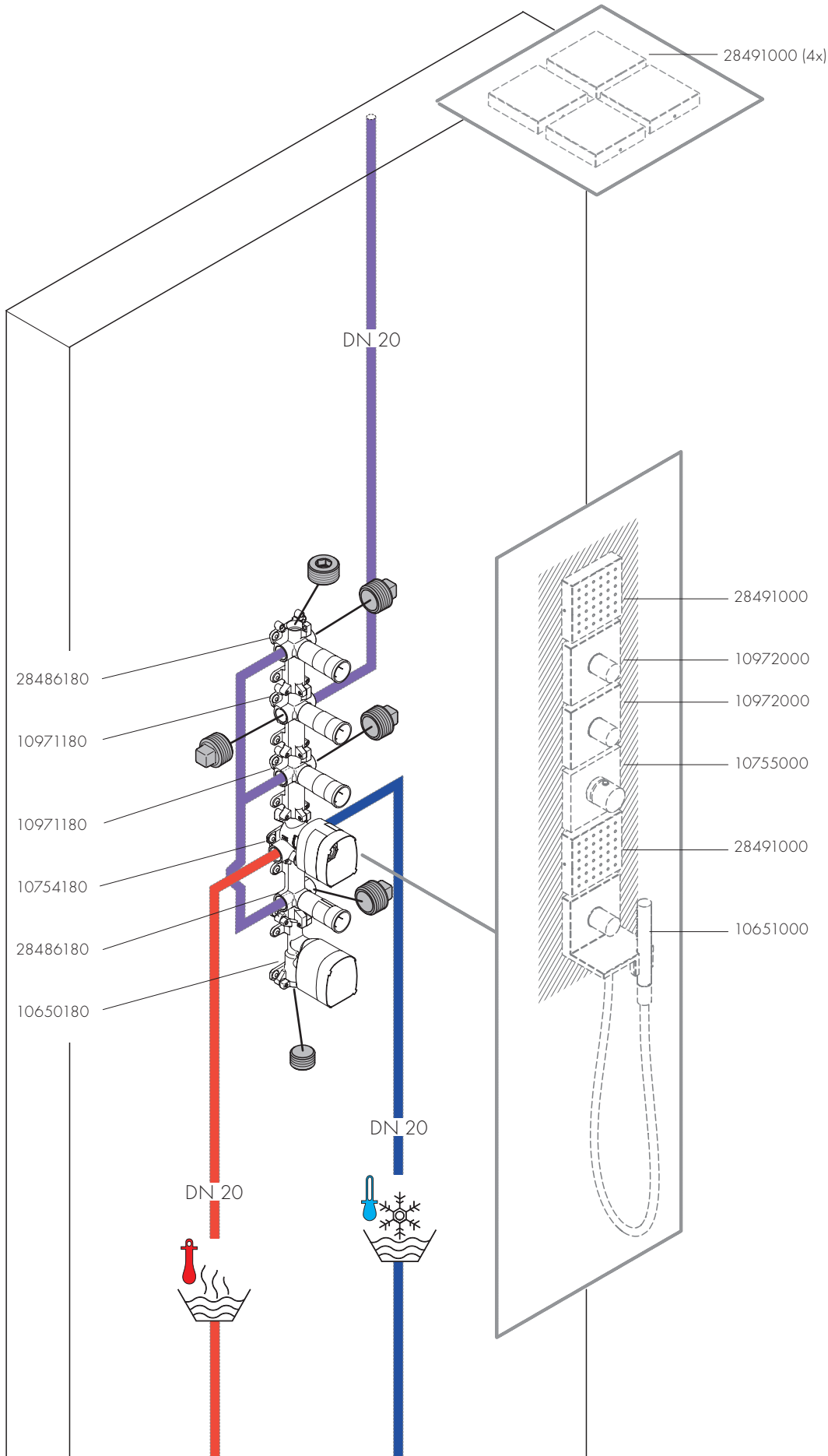

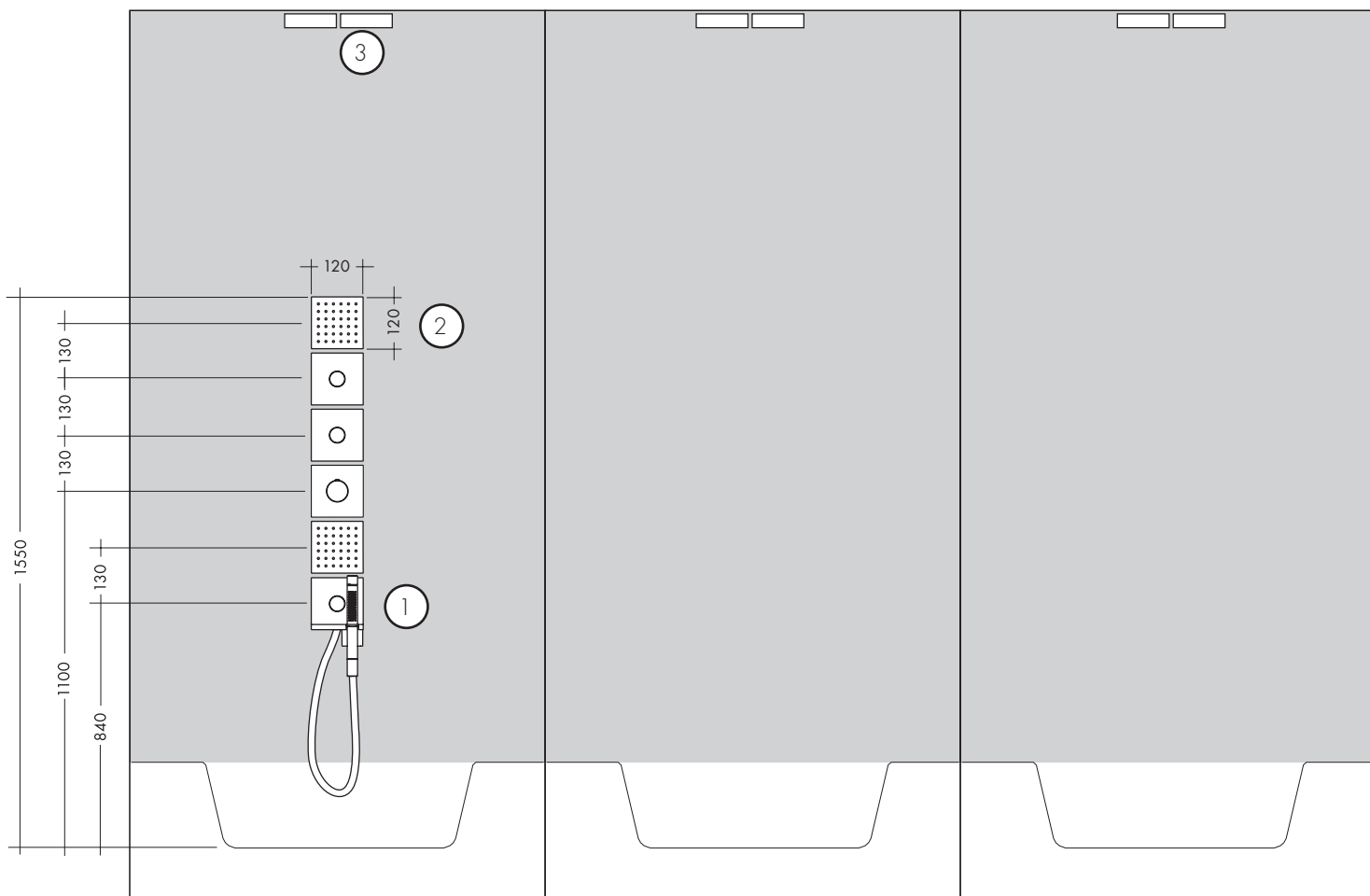
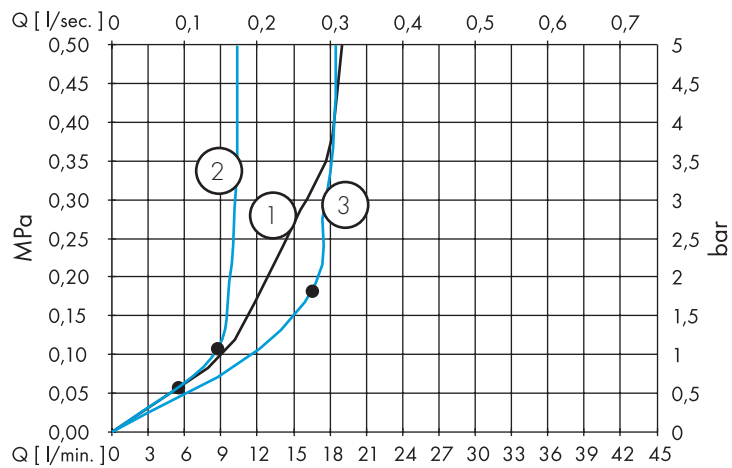

AXOR Showerheaven (970 x 970)
10621800 / 10623800

AXOR Showerheaven (720 x 720)
10625800 / 10627800

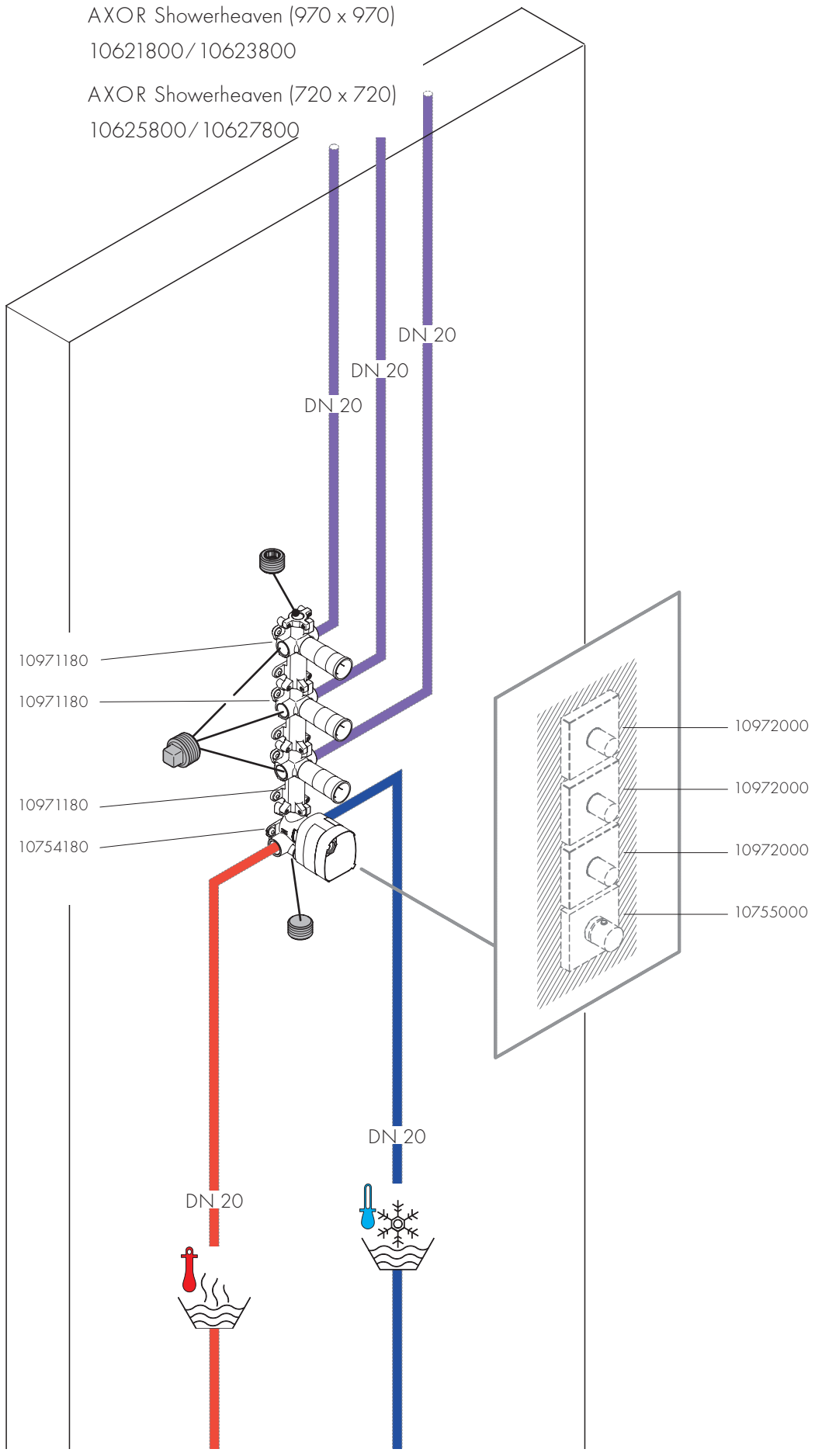

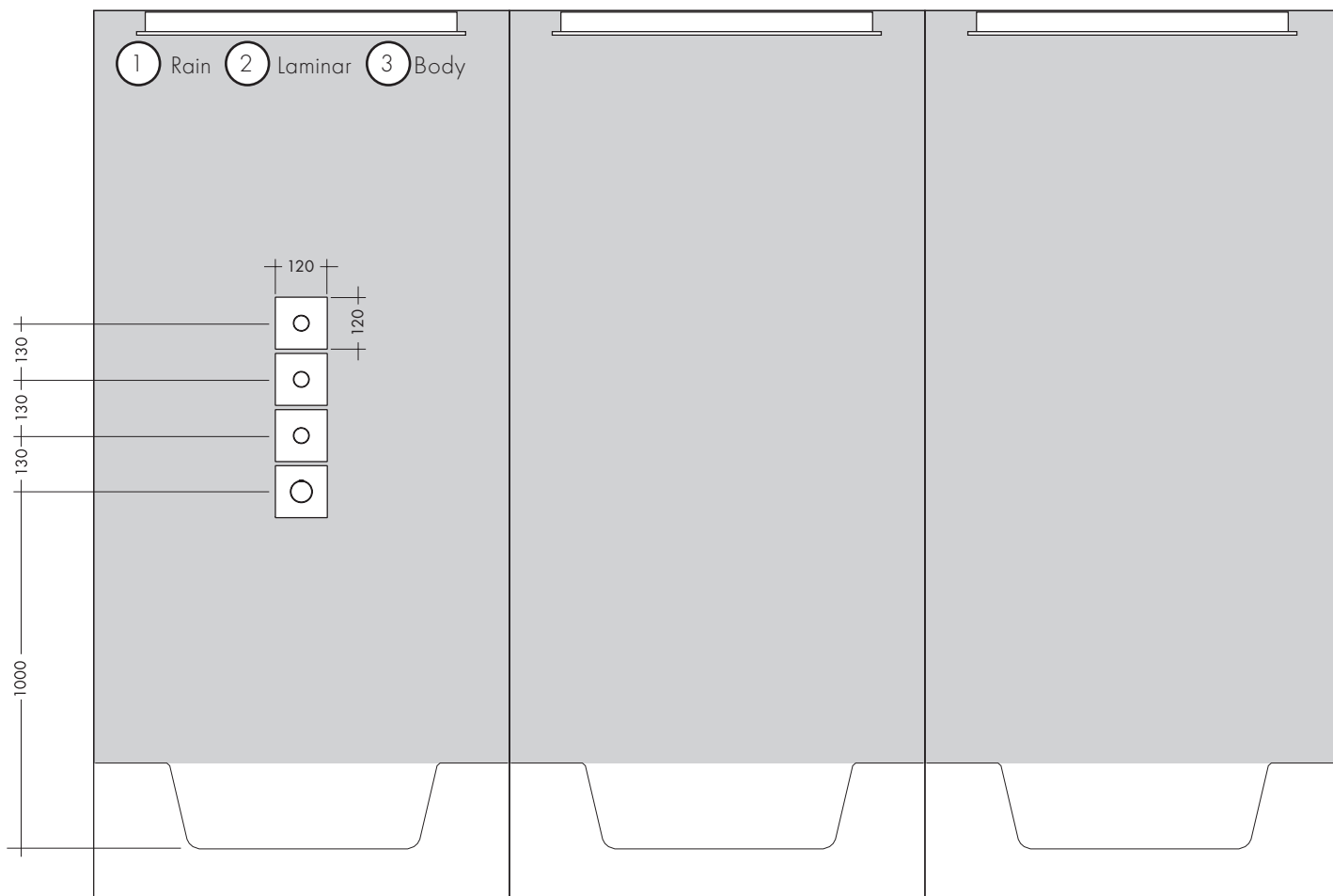
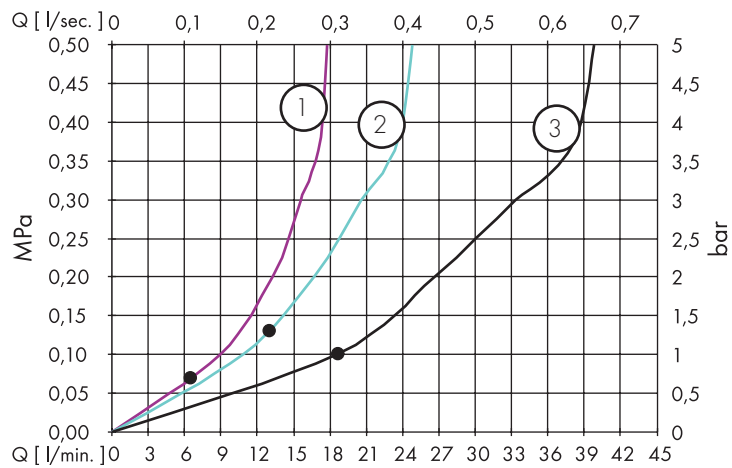

AXOR Showerheaven (970 x 970)

10621800/10623800

AXOR Showerheaven (720 x 720)

10625800/10627800

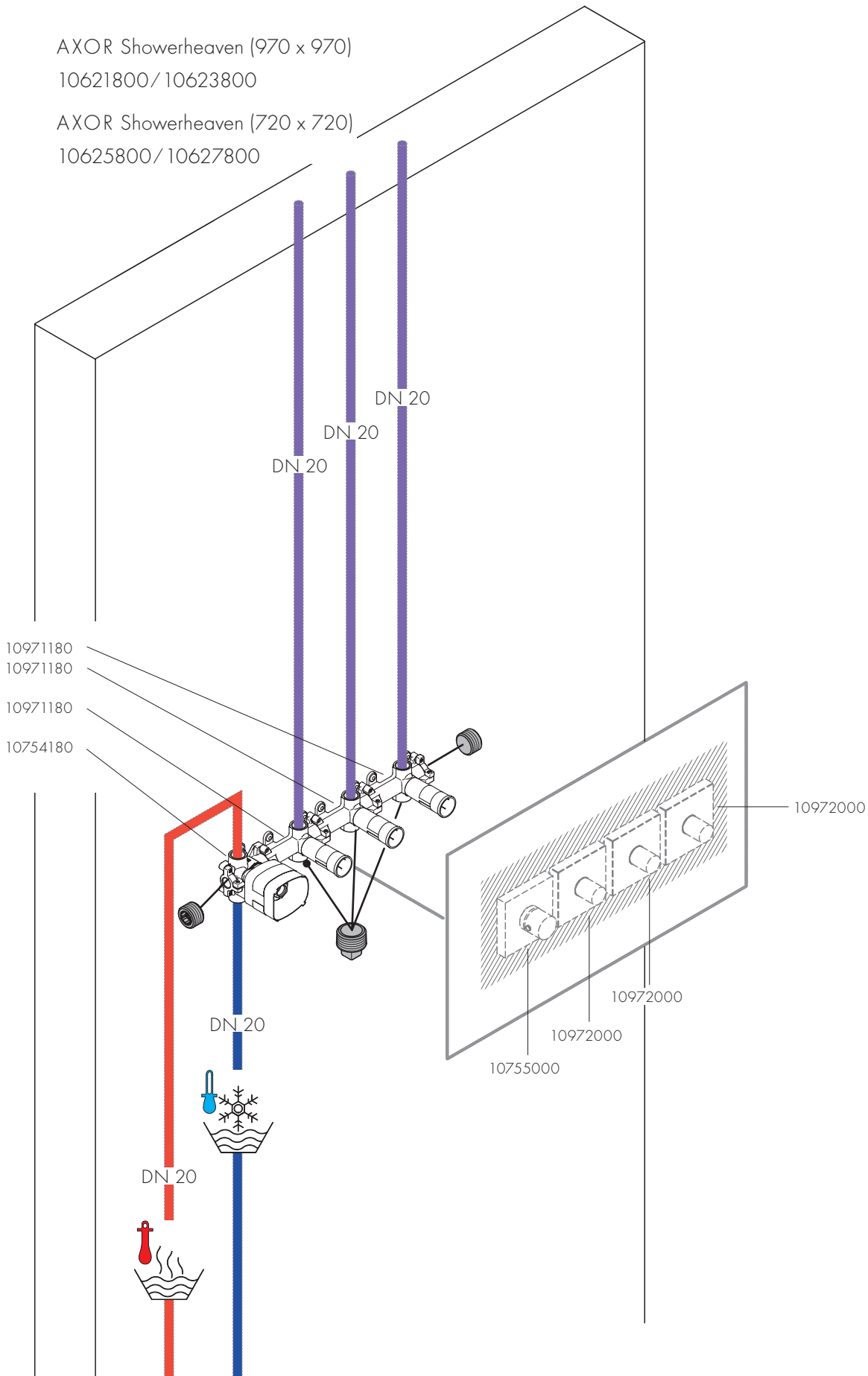

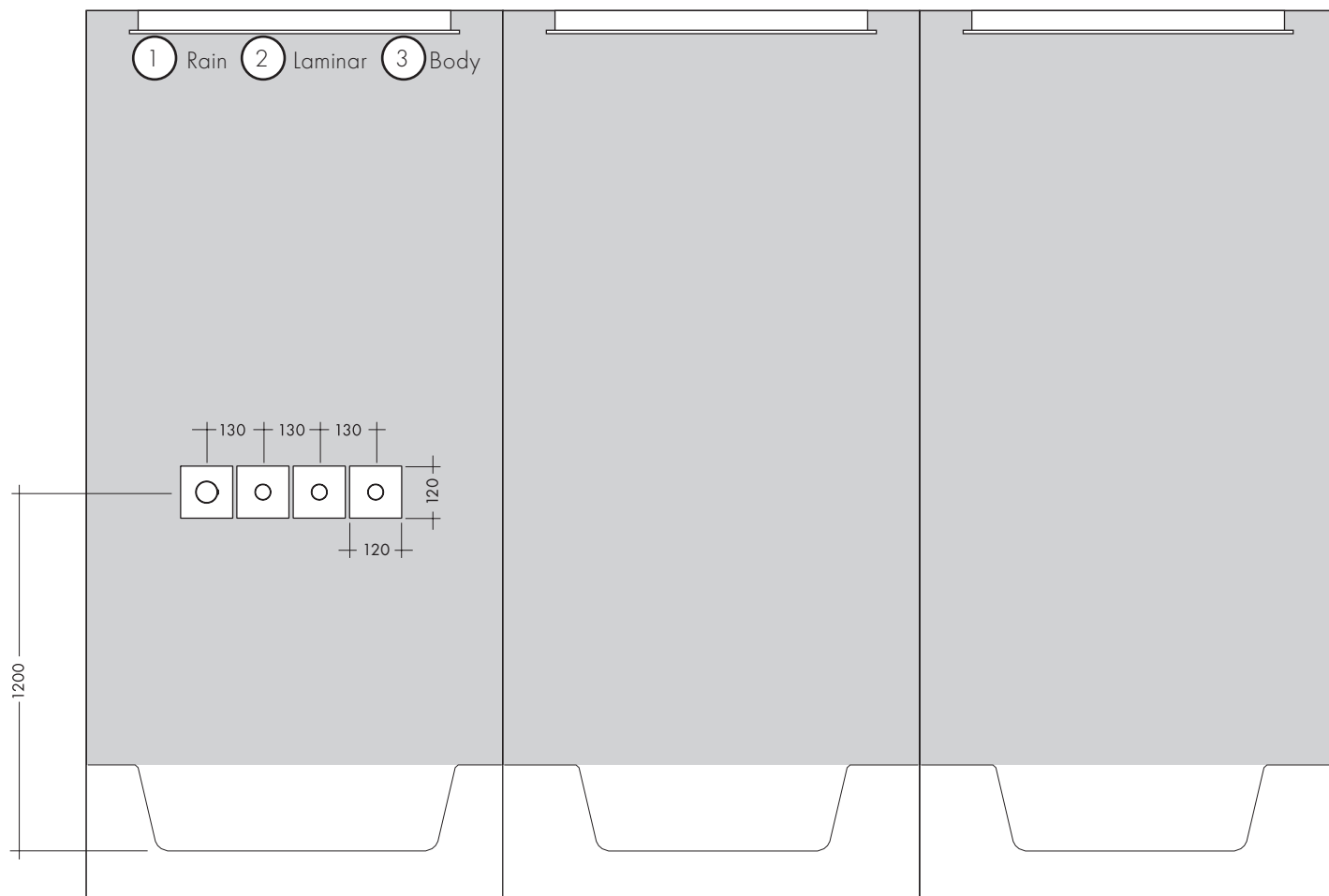
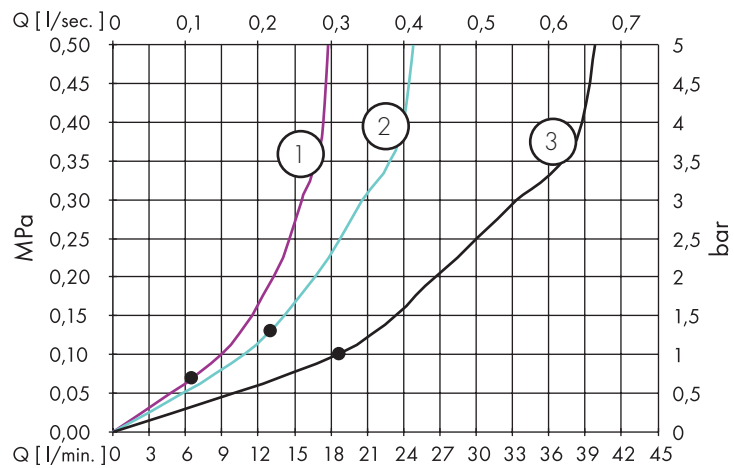

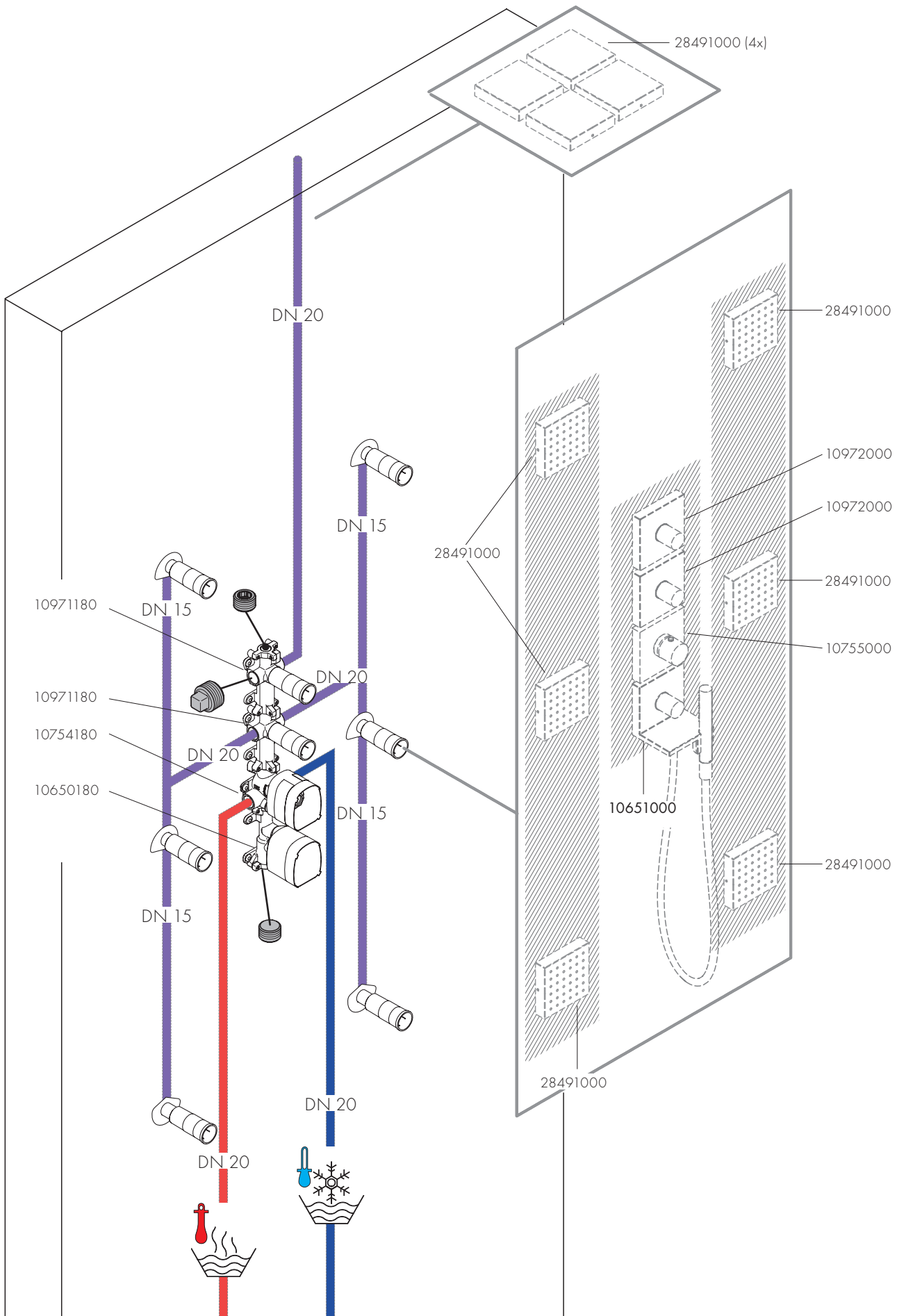

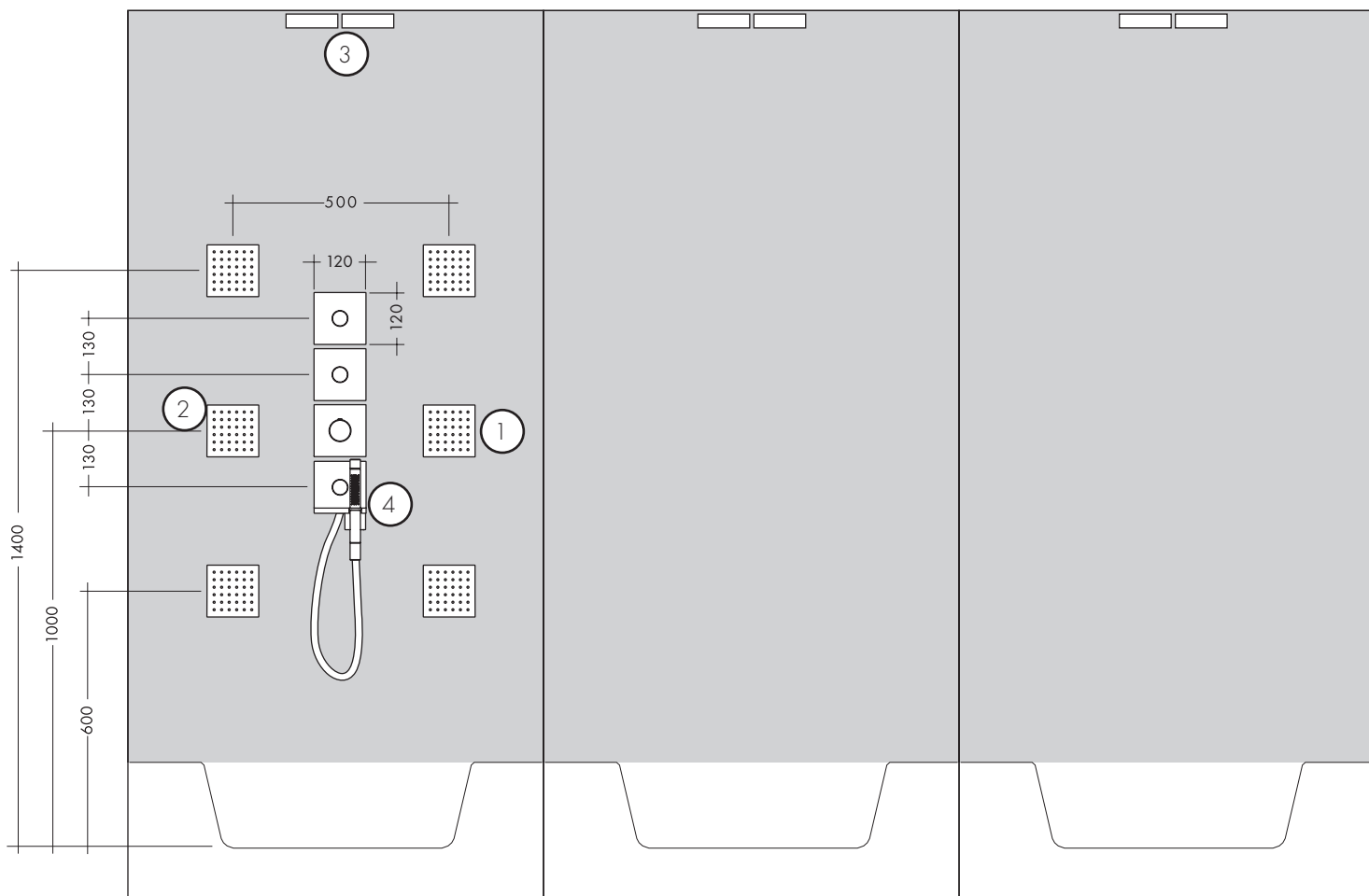
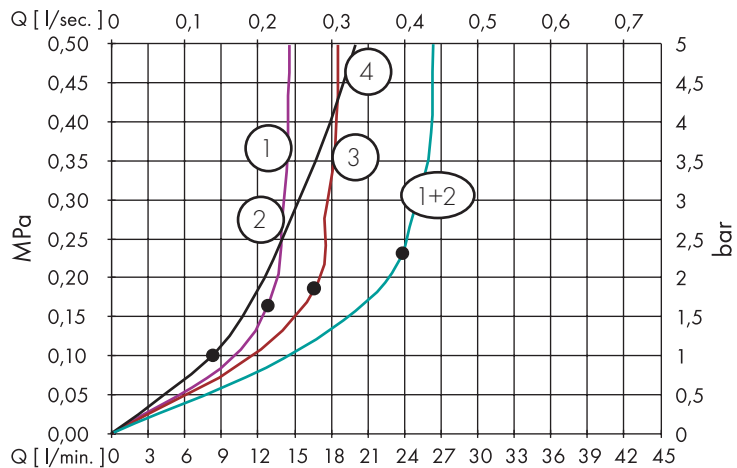

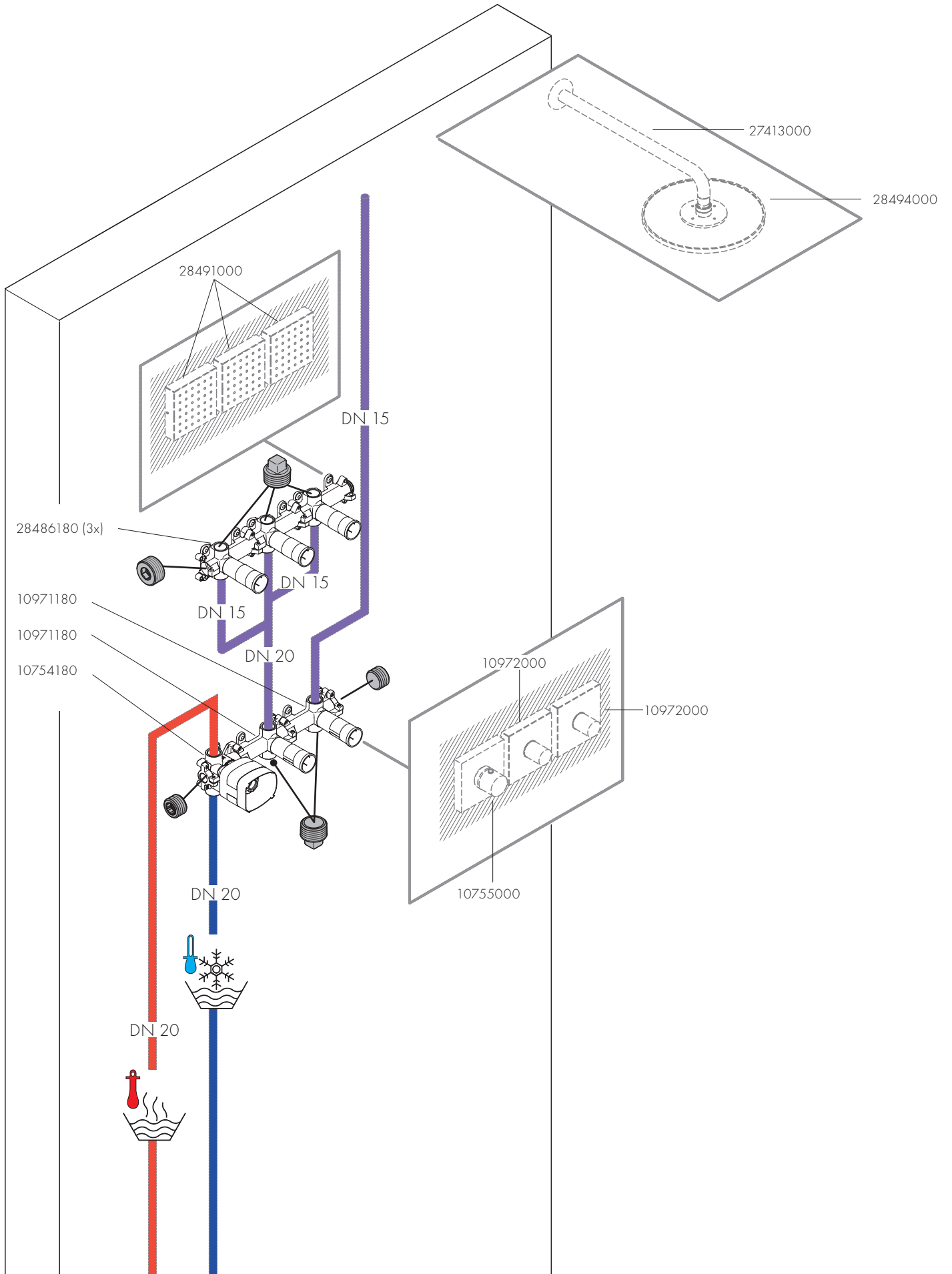

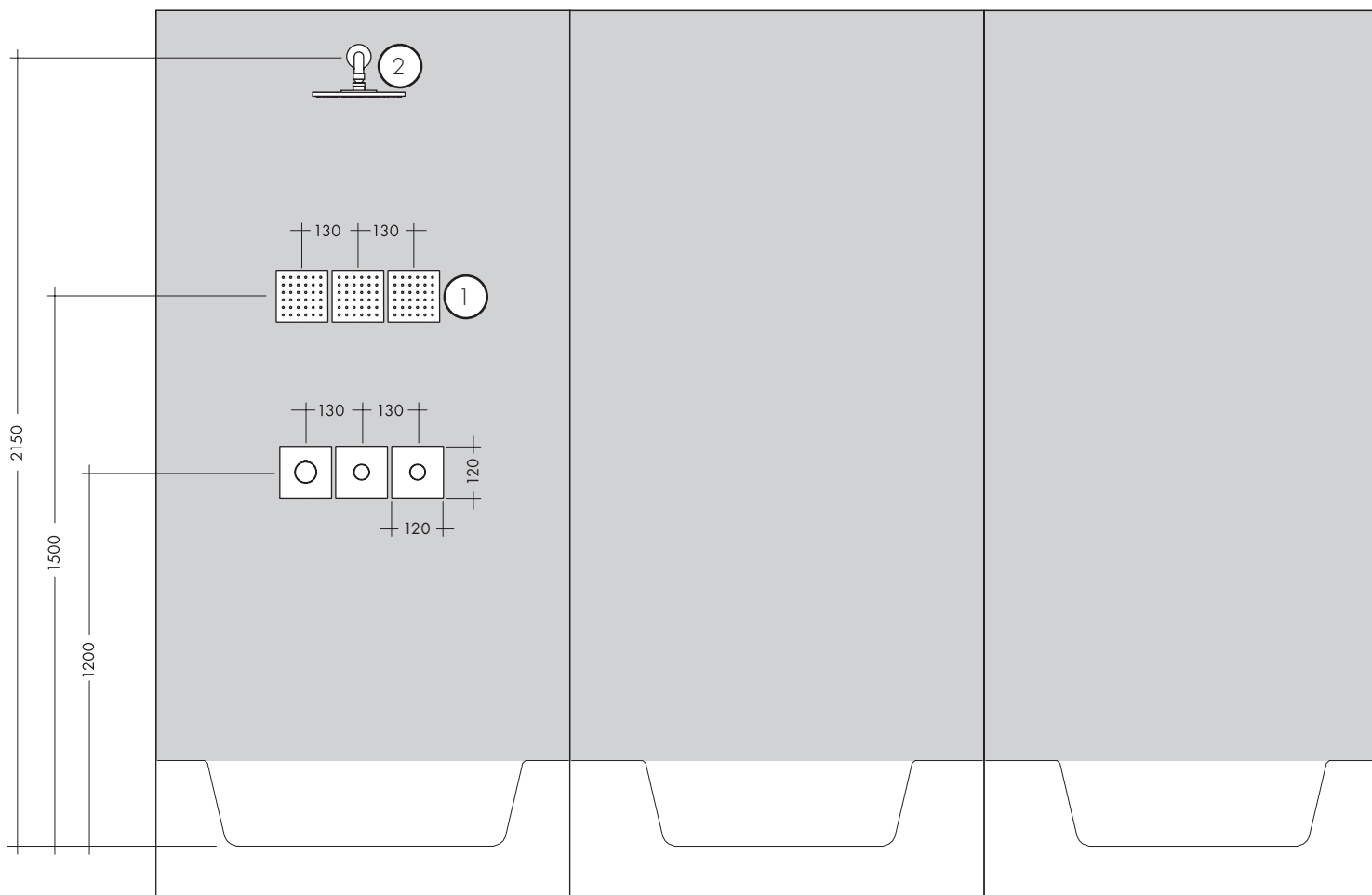
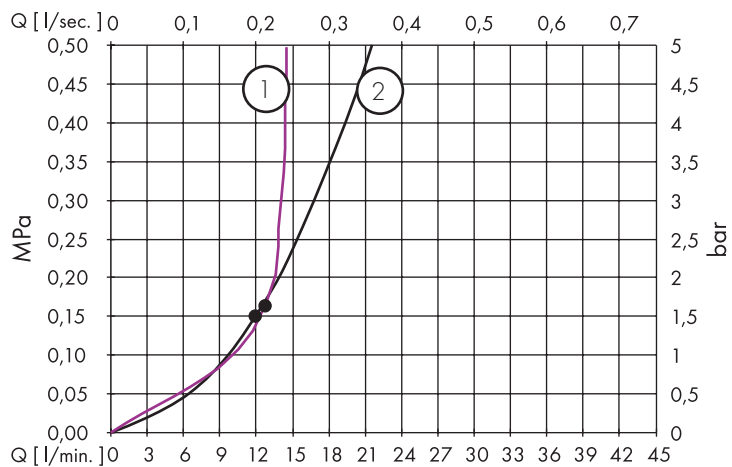

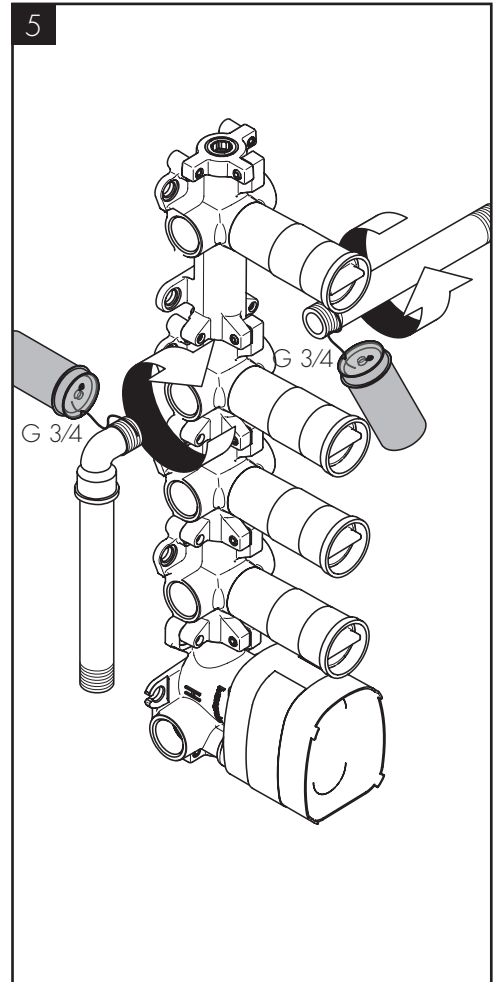
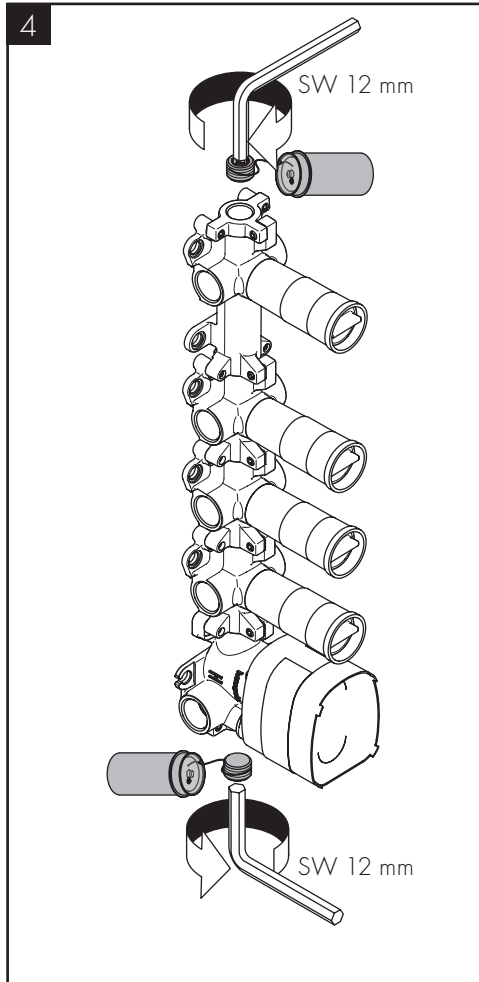
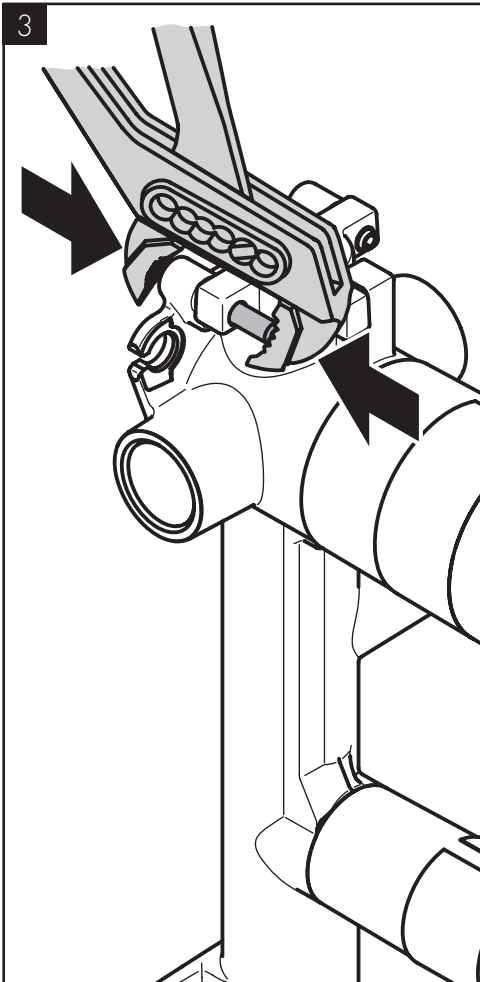
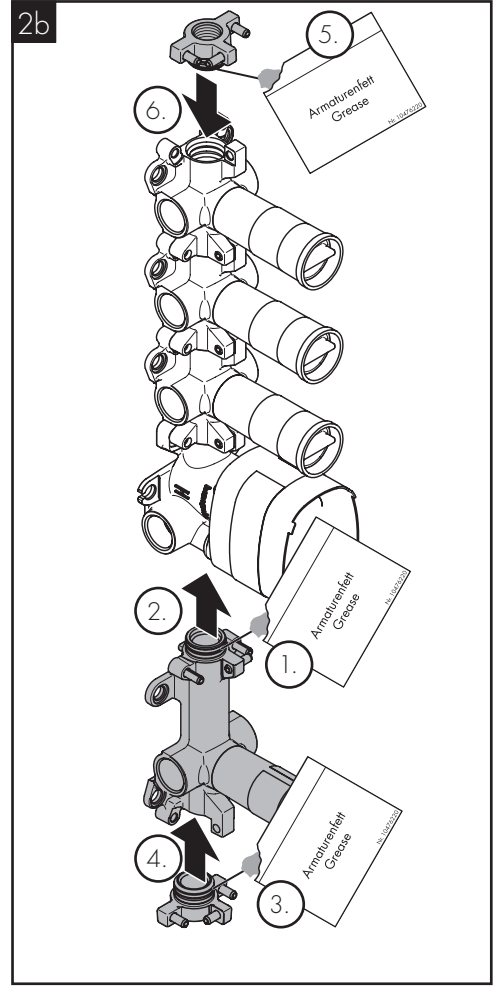
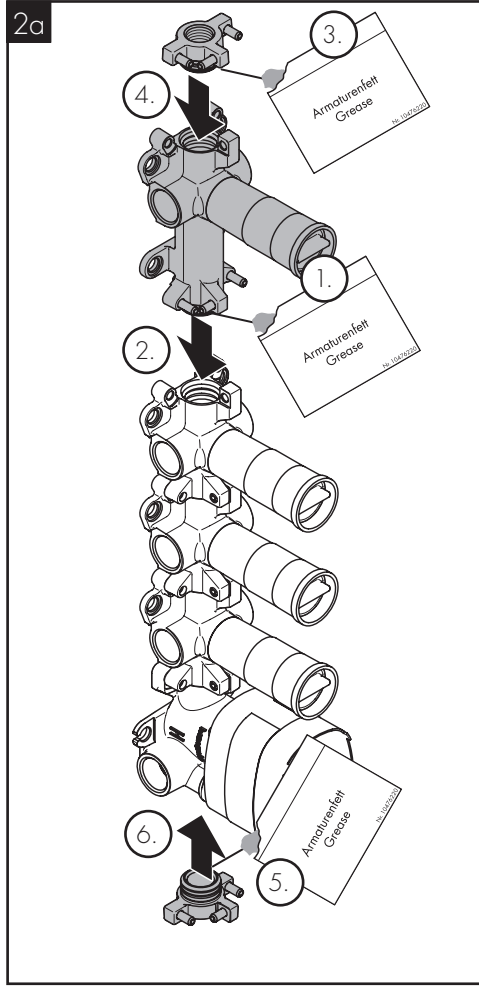
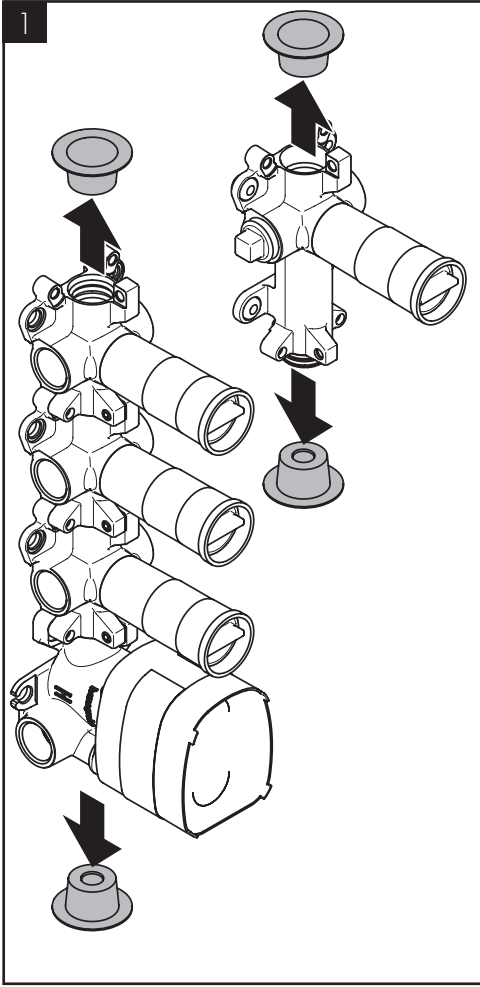

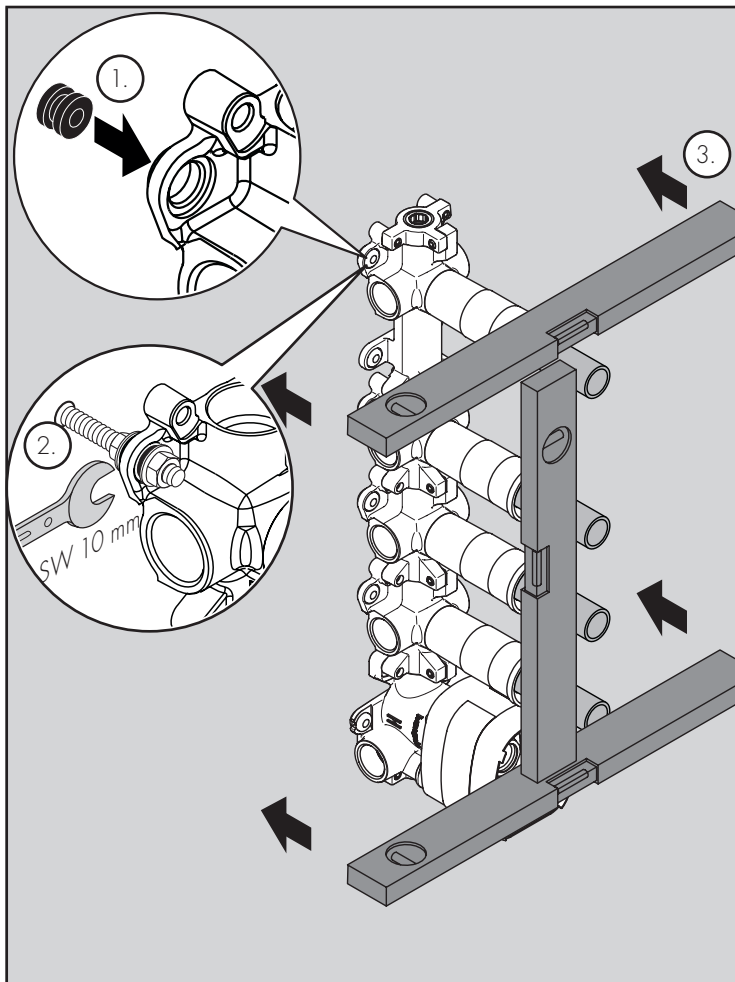
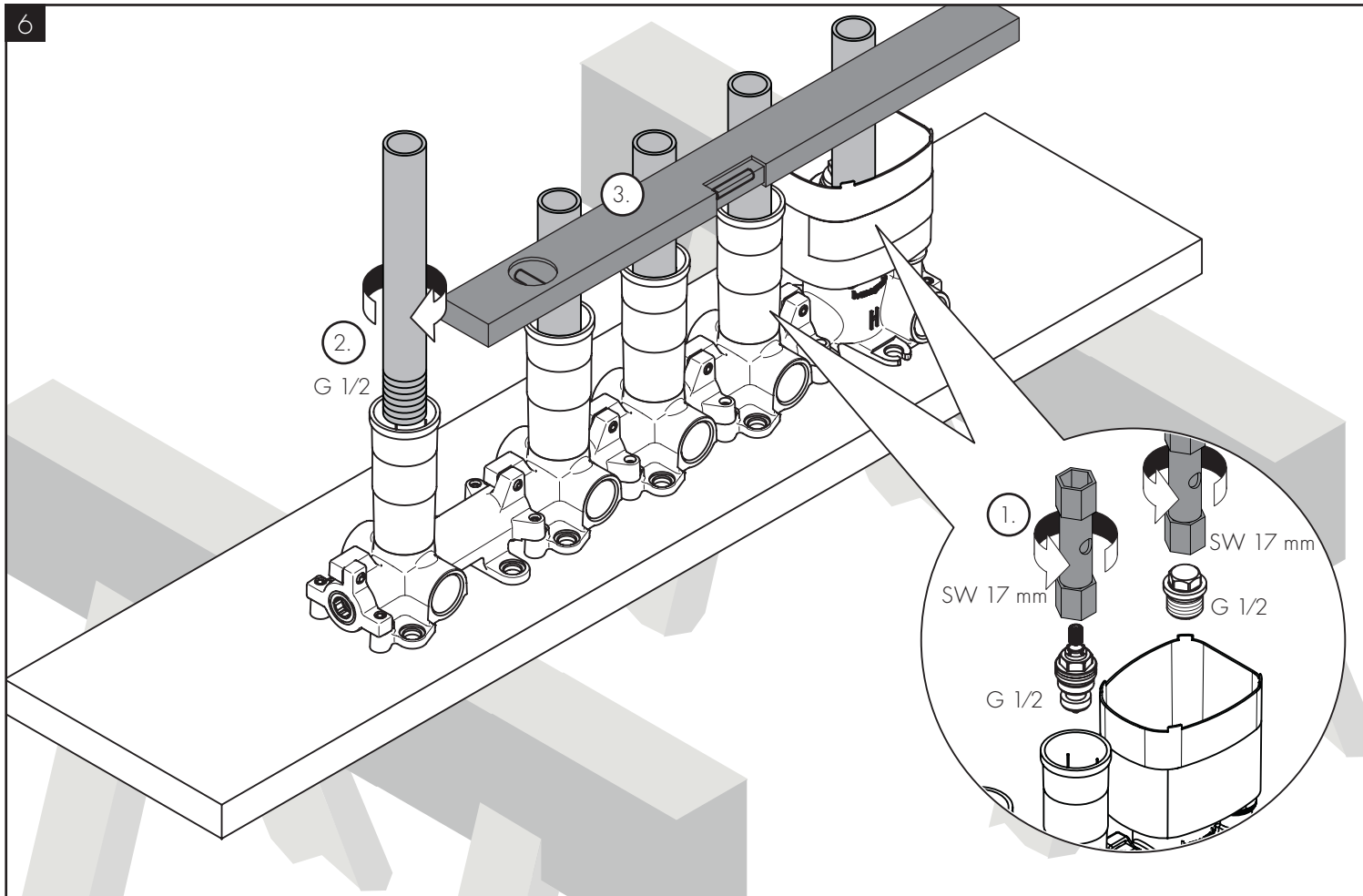

max./maks./最大/بیشترین/не
 более./ne daugiau kaip/ħak/azami/
 έως

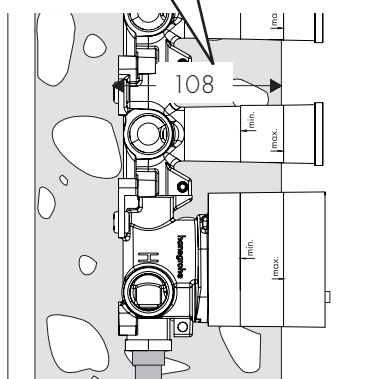

min./分钟/بیشترین/мин/перс/dak

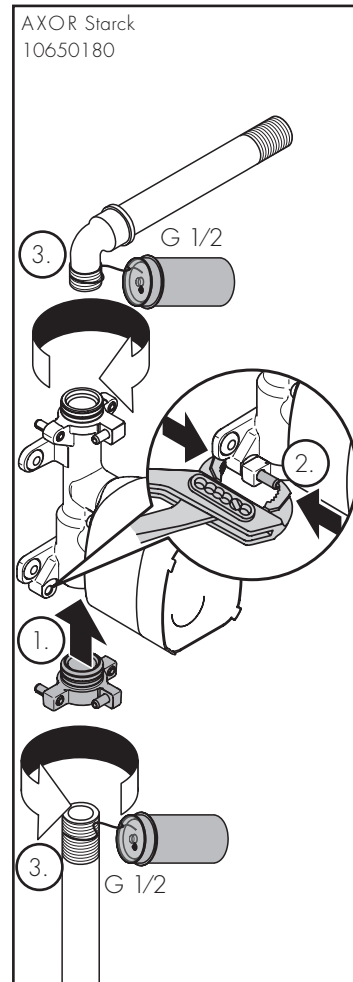
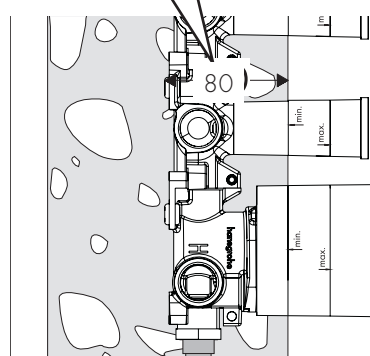



- DE / Spülen der Leitungen
 FR / Rincer les conduites
 EN / Flushing of the pipes.
 IT / Far scorrere l'acqua nel tubo
 ES / limpiar lavando los conductos
 NL / Doorspoelen van de leidingen
 DK / Skylling af ledninger
 PT / Lavagem das tubagens
 PL / Płukanie przewodów
 RU / Промывка трубопроводов
 CS / vypláchnout vedení
 SK / Vypláchnutie vedení.
 ZH / 冲洗管道。
 HU / A vezetékek öblítése
 FI / Johdotusten huuhtelu
 SV / Spola ledningarna
 LT / Išplauti vamzdžius
 HR / Ispiranje slavina
 TR / Hatların yıkanması
 RO / Spălarea conductelor
 EL / Καθαρισμός των αγωγών
 SL / Izpiranje cevi
 ET / Torude loputamine
 LV / Ūdens vada skalošana
 SR / Ispiranje cevi
 NO / Spyling av ledninger
 BG / Промиване на тръбопроводите
 SQ / Shpëlarja e lidhjeve
 AR / ريساومنا لبيسة

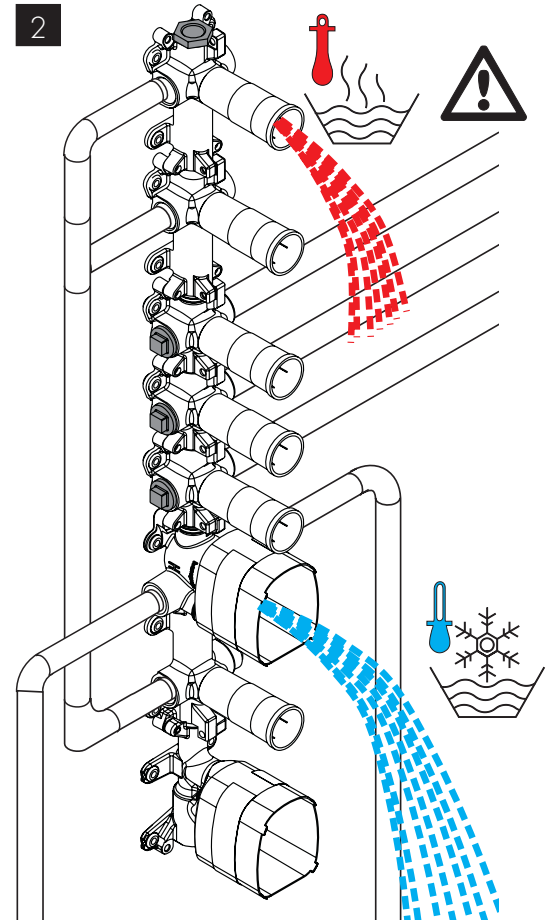
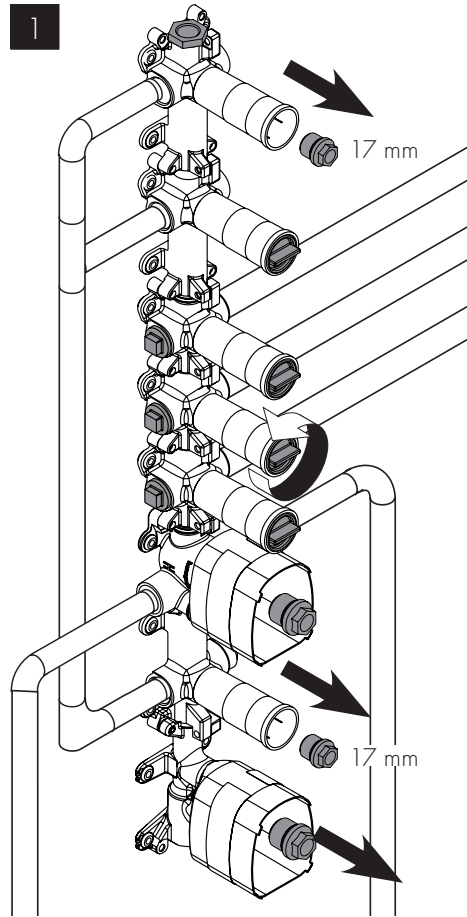

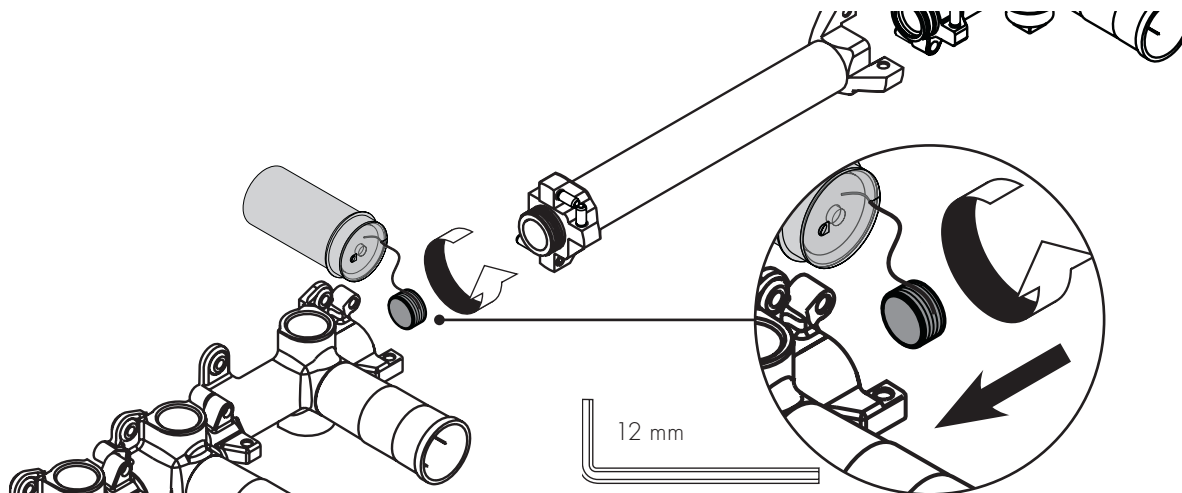

DE / Stopfen einschrauben

Folgt nach dem Grundkörper 40878/40877 kein Absperrventil, dann beigelegten Stopfen eindichten und einschrauben. So wird stagnierendem Wasser vorgebeugt.

FR / Visser l'obturateur

Si une vanne d'arrêt ne se trouve pas en aval du corps de base 40878/40877, étancher et visser l'obturateur fourni, évitant la stagnation d'eau.

EN / Screw in the plug

If there is no shutoff valve behind the basic body 40878/40877, seal the included plug and screw it in. This will prevent stagnating water.

IT / Avvitare i tappi

Se dopo il corpo base 40878/40877 non segue nessuna valvola d'arresto, allora ermetizzare il tappo e avvitarlo. Con ciò si previene a dell'acqua stagnata.

ES / Enrosca tapones

Si después del cuerpo básico 40878/40877 no sigue ninguna válvula de cierre, entonces se debe hermetizar y enrosca los tapones incluidos. De este modo se evita la acumulación de agua.

NL / Stop erin schroeven.

Indien na het basislichaam 40878/40877 geen afsluitklep volgt, moet de bijgevoegde stop afgedicht en ingeschroefd worden. Zo wordt stilstaand water voorkomen.

DK / Prop skrues i

Er der ikke nogen afspærringsventil efter grundelementet 40878/40877, tættes vedlagte prop ind og skrues i. Således forebygges stagnerende vand.

PT / Enrosca o bujão

Se depois do corpo base 40878/40877 não se seguir nenhuma válvula de vedação, não se deve enrosca nem vedar o bujão fornecido. Desta forma previne a formação de água estagnada

PL / Wkręcanie korka

Jeżeli za korpusem 40878/40877 nie ma żadnego zaworu odcinającego, wówczas należy uszczelnić i wkręcić dołączony korek. W ten sposób zapobiega się gromadzeniu wody.

CS / Našroubování uzávěrů

Jestliže za základním tělesem 40878/40877 nenásleduje uzavírací ventil, potom utěsněte a našroubujte přiložené uzávěry. Předěje se tím stagnující vodě.

SK / Naskrutkovanie uzáverov

Ak za základným telesom 40878/40877 nie je uzatvárací ventil, potom utesnite a naskrutkujte priložené uzávěry. Predide sa tým stagnujúcej vode.

ZH / 拧固堵头

基础 40878 40877 之后无截止阀，因此用堵头进行密封并用螺钉拧固。以防水平滞。

RU / Ввинтите заглушки

Если за основной частью 40878/40877 нет запорного клапана, тогда загерметизируйте и ввинтите приложенные заглушки. Таким образом, удаётся предотвратить застаивание воды.

HU / Dugó becsavarása

Ha a 40878/40877 készüléktől után nincs zárószelvény, akkor a mellékelt dugó kell behelyezni és becsavarni. Így meg lehet előzni a víz pangását.

FI / Tulpat ruuvataan kiinni

Jos perusosan 40878/40877 jälkeen ei tule sulkuventtiiliä, mukana olevat tulpat tiivistetään ja ruuvataan kiinni. Näin estetään veden kerääntyminen.

SV / Skruva i propp

Om det inte finns en spärrventil efter basenheten 40878/40877 ska den medföljande proppen sättas i och skrivas fast. Detta förebygger vattenstagnation.

LT / Kamščio užsukimas

Jeigu už pagrindinės dalies 40878/40877 nėra skiriamoji vožtuvu, užsandarinkite ir užsukite pridodamus kamščius. Taip išvengiama vandens užsistovėjimo.

HR / Zavrtanje čepa

Ako iza tijela 40878/40877 ne slijedi zaporni ventil, onda priloženi čep treba zabrtviti i zavrtnuti. Na taj se način izbjegava stagniranje vode.

TR / Tapayı takın

Temel gövde 40878/40877' den sonra kapatma vanası yoksa, birlikte verilen tapayı izole edin ve vidalayın. Böylece suyun durgunlaşması önlenir.

RO / Înșurubarea dopului

În cazul în care după corpul de bază 40878/40877 nu este montată o supapă de închidere, etanșajți dopul anexat și înșurubați-l. În acest fel veți evita formarea apei stagnante.

EL / Βιδώστε το βύσμα

Εφόσον δεν εγκατασταθεί μετά το βασικό στοιχείο 40878/40877 μια βαλβίδα διακοπής, θα πρέπει το βύσμα να βιδωθεί και να στεγανοποιηθεί ώστε να μην συγκεντρώνεται νερό.

SL / Uvijte zamašek

Če za osnovnim elementom 40878/40877 ni nameščena zaporna ventila, zatesnite in uvijte priložen zamašek. Tako preprečite nabiranje stagnirajoče vode.

ET / Keerake kork sisse.

Kui põhikerale 40878/40877 ei järgne sulgurventiili, siis tihendage kork ja keerake sisse. Sellega väldite seisvat vett.

LV / Aizbāžņu ieskrūvēšana

Ja pēc pamatnes 40878/40877 neseko slēgvārsts, noblīvējiet un ieskrūvējiet pievienotos aizbāžņus. Tādējādi tiek novērsta ūdens sastāšanās.

SR / Skru inn plugg

Hvis ikke det følger en sperreventil etter basiskabinettet 40878/40877 skal man skru inn og tette med medlevert plugg. Slik forebygges stagnerende vann.

NO / Skru inn plugg

Hvis ikke det følger en sperreventil etter basiskabinettet 40878/40877 skal man skru inn og tette med medlevert plugg. Slik forebygges stagnerende vann.

BG / Завинтете пробката

Ако след основното тяло 40878/40877 няма спиращен клапан, тогава уплътнете и завинтете приложената пробка. Така се предотвратява застоя на вода.

SQ / Vidhosni tapën

Nëse pas njësisë kryesore 40878/40877 nuk vjen asnjë valvul bllokuese, atëherë izoloni dhe vidhosni tapat e dërguara. Në këtë mënyrë do të parandalohet uji i ndenjtur.

AR /

تركيب السدادات

إذا لم يتبع الجسم الرئيسي / صمام مانع للتدفق، قم بتركيب السدادات المرفقة وثبتها بإحكام، مما سيمنع تكون أي مياه راكدة.

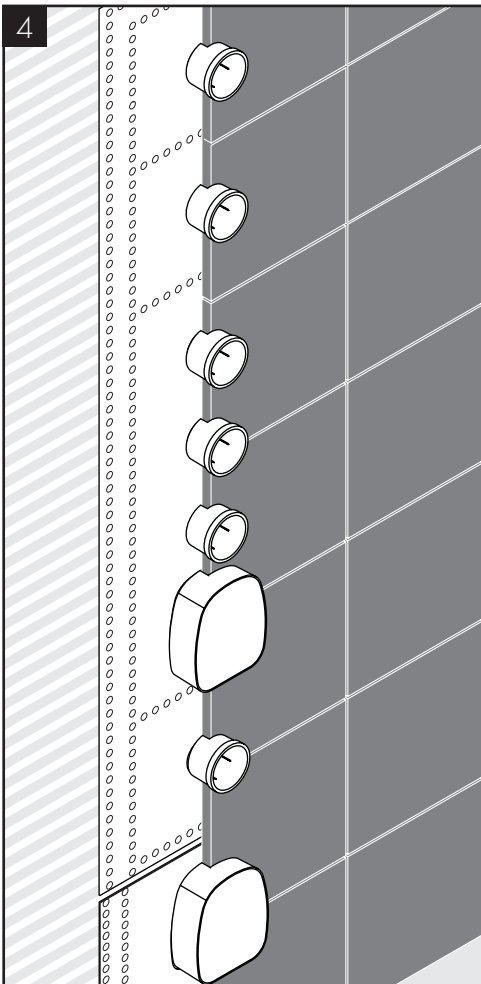
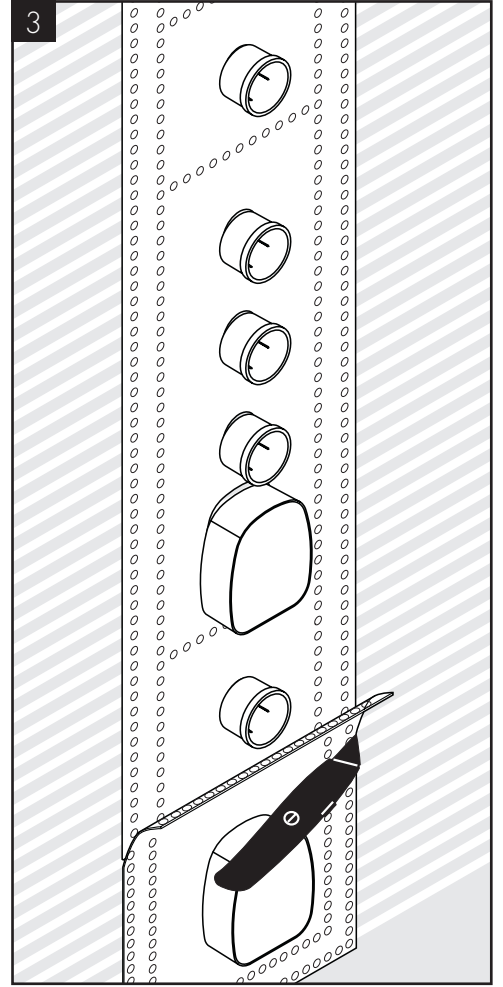
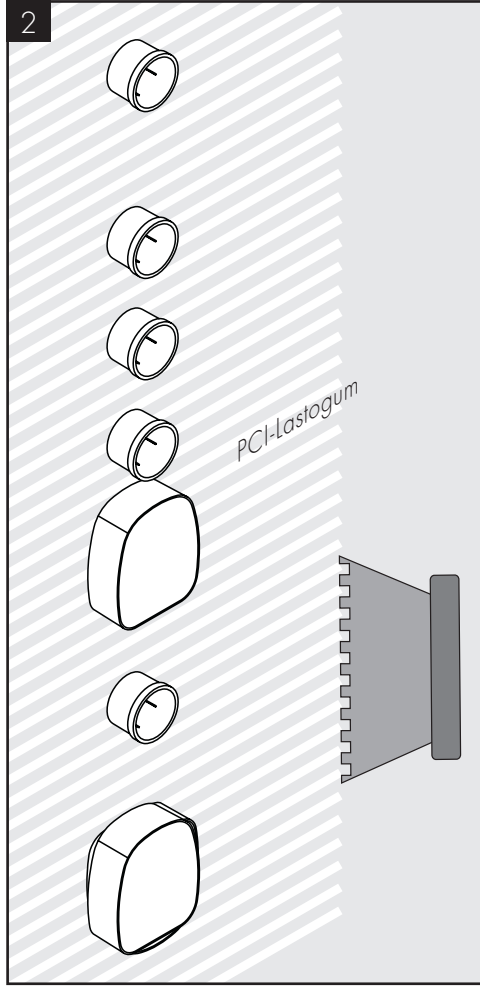
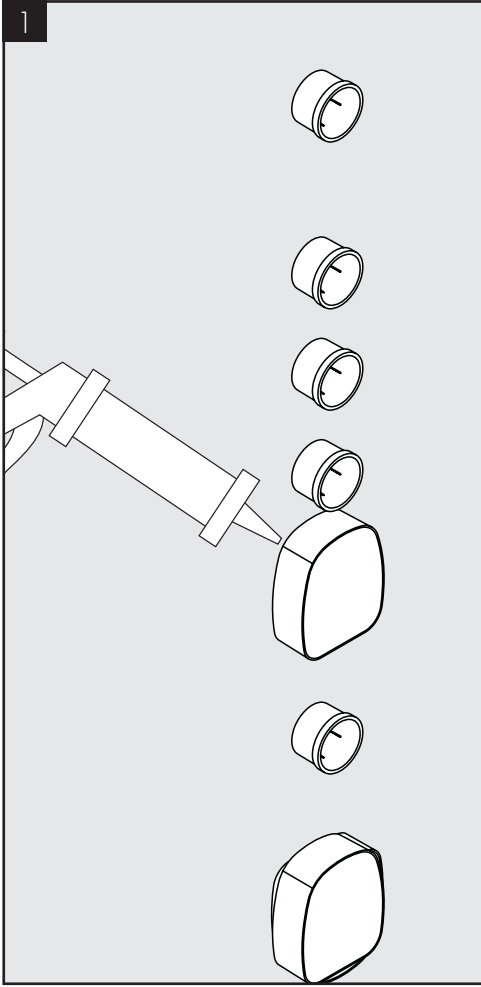

AXOR ShowerCollection

10754180

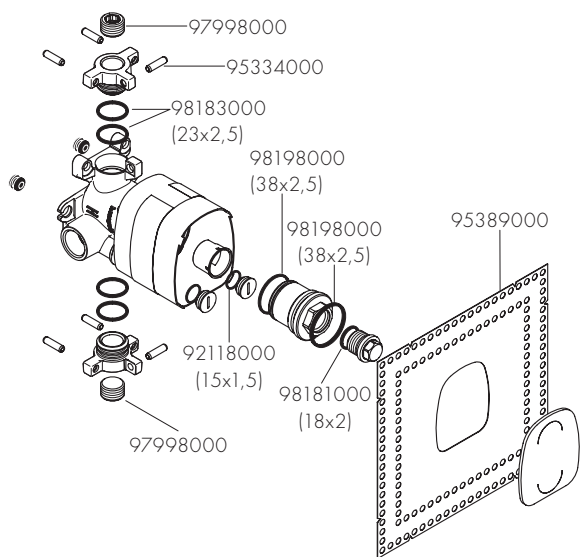

AXOR

AXOR / Hansgrohe SE
Austraße 5-9
77761 Schiltach
Deutschland

info@axor-design.com
axor-design.com

03/2019
9.04952.03