

Installation

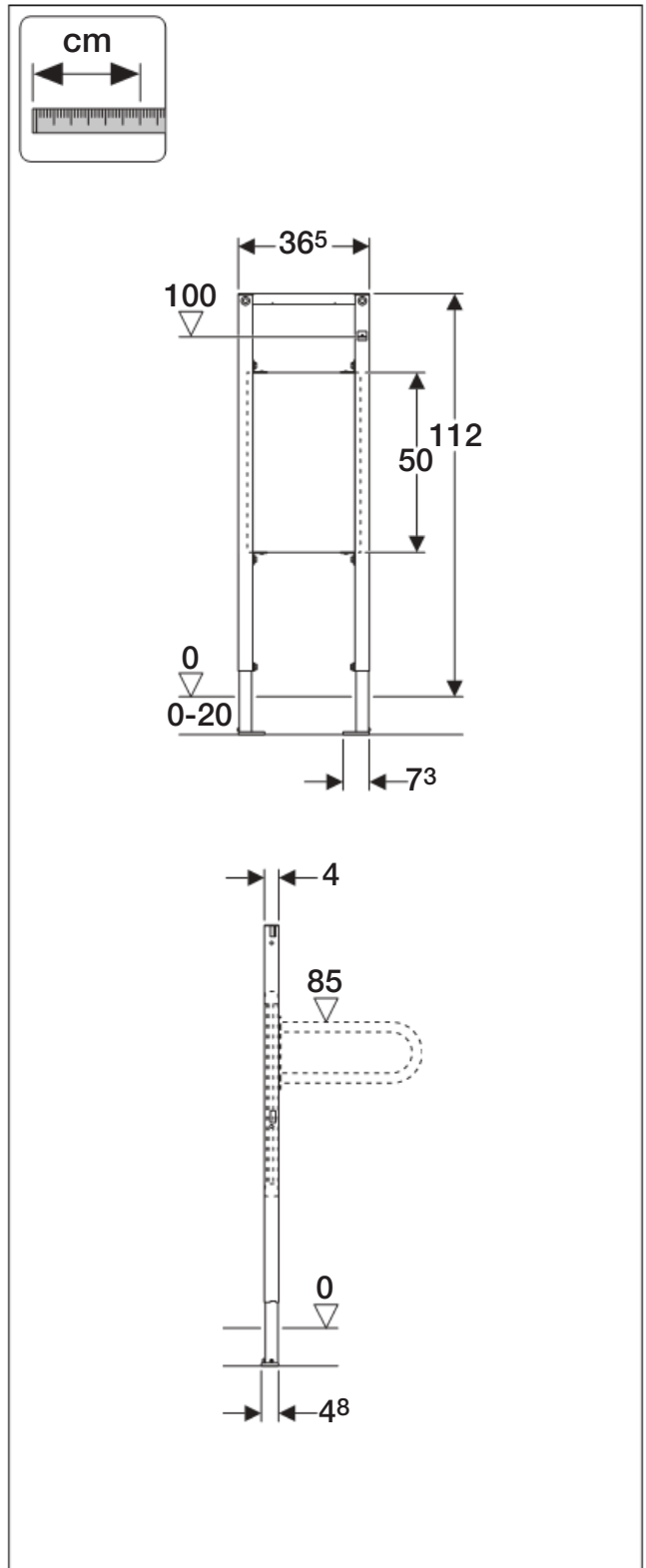

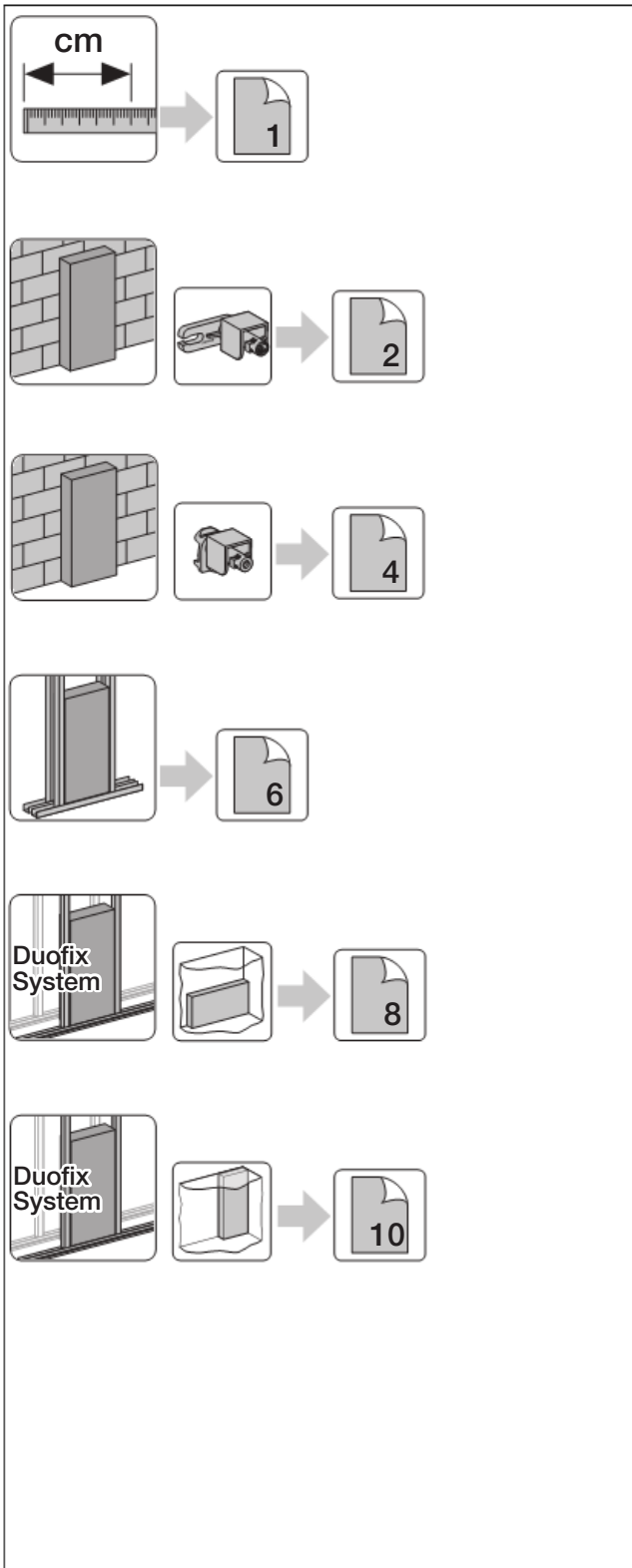

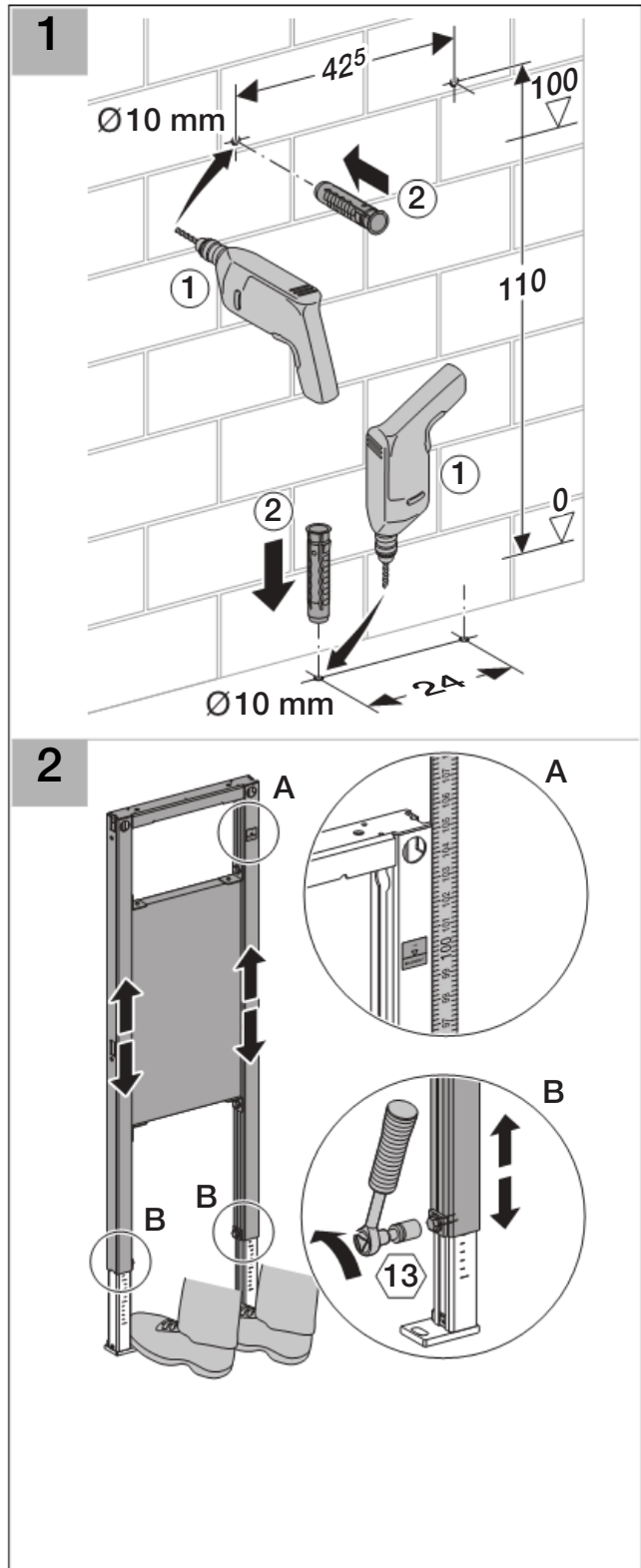

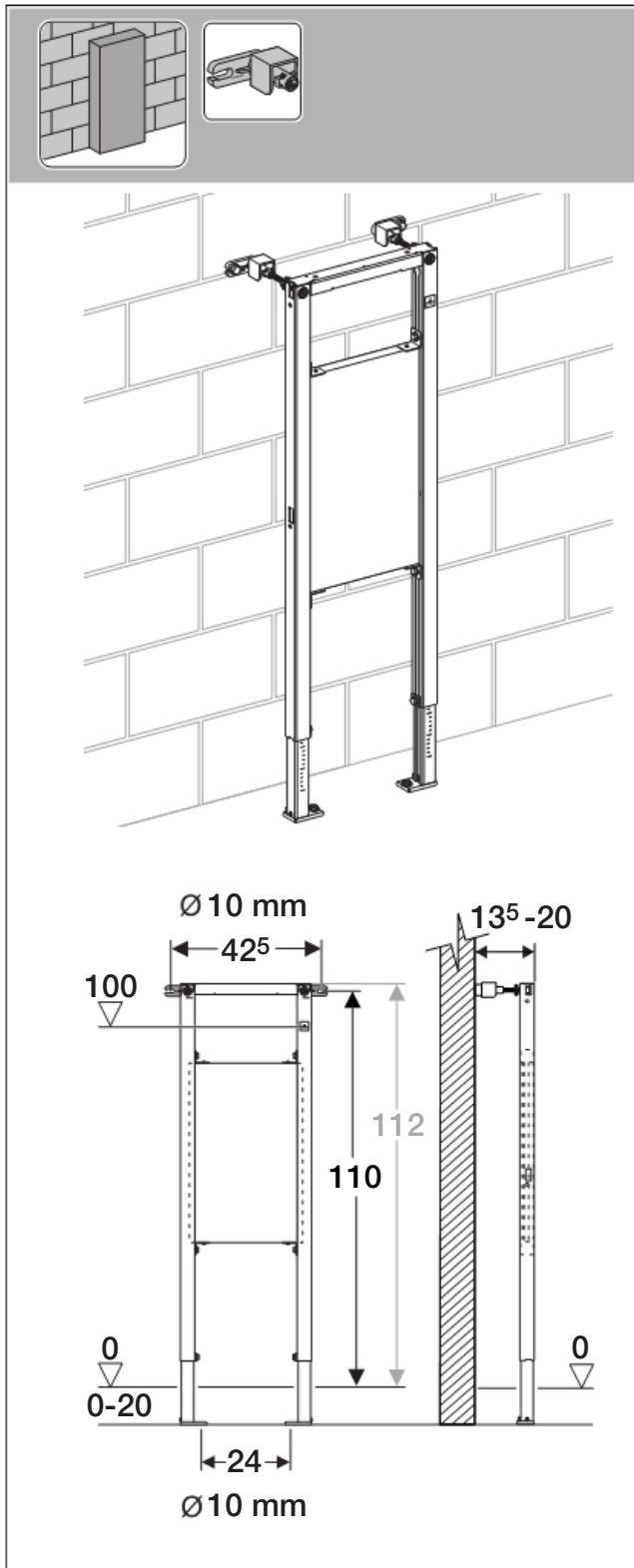
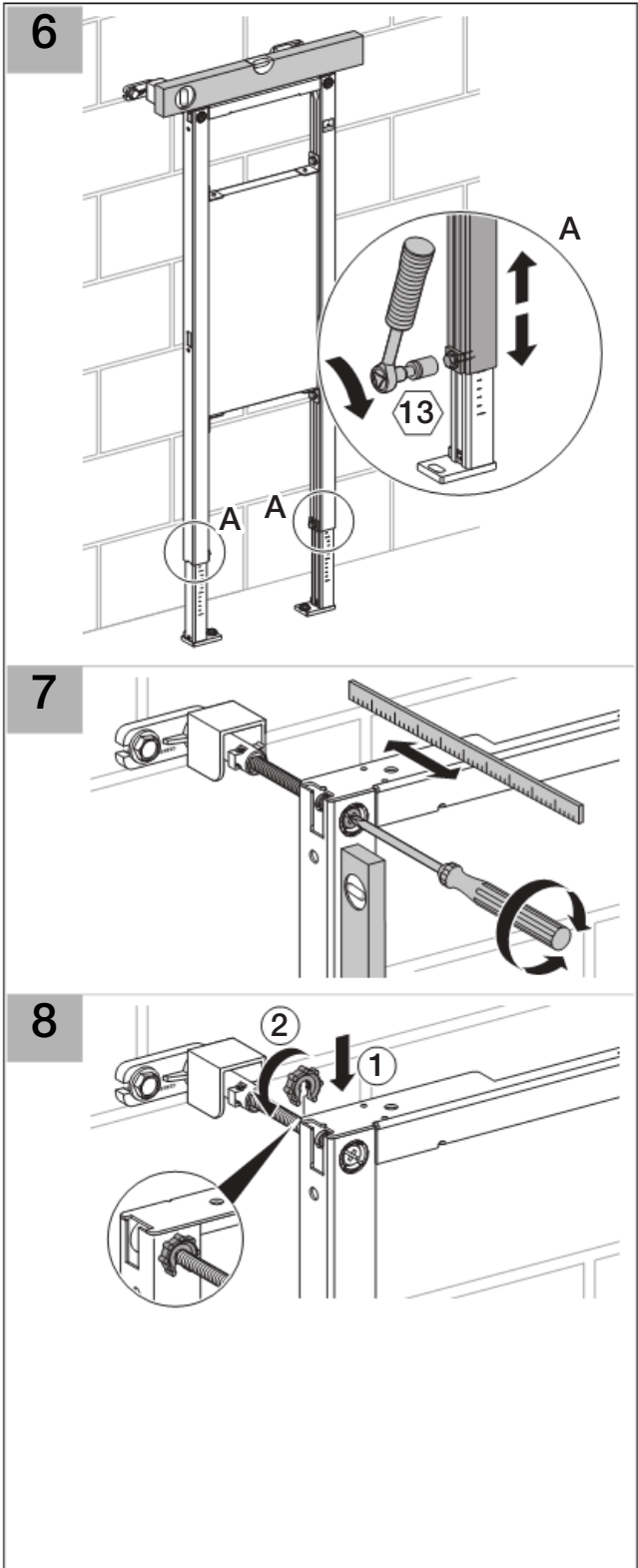
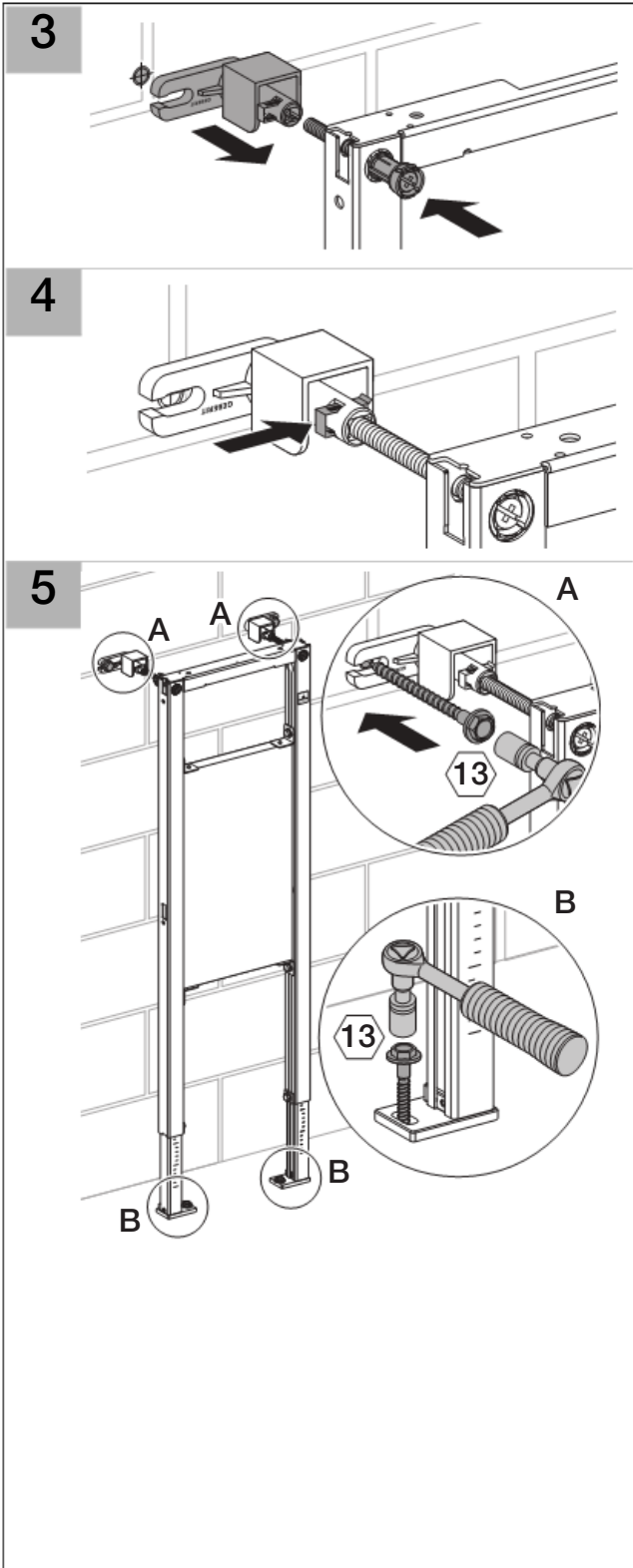
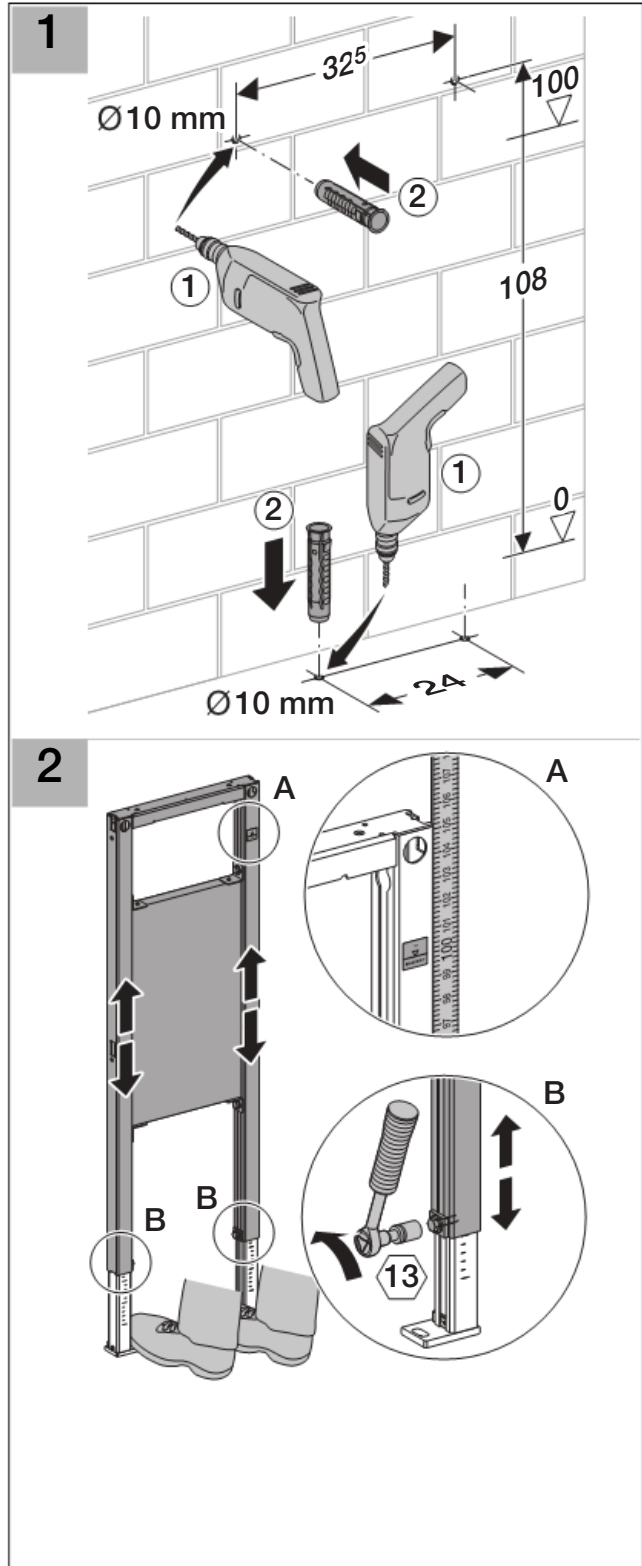
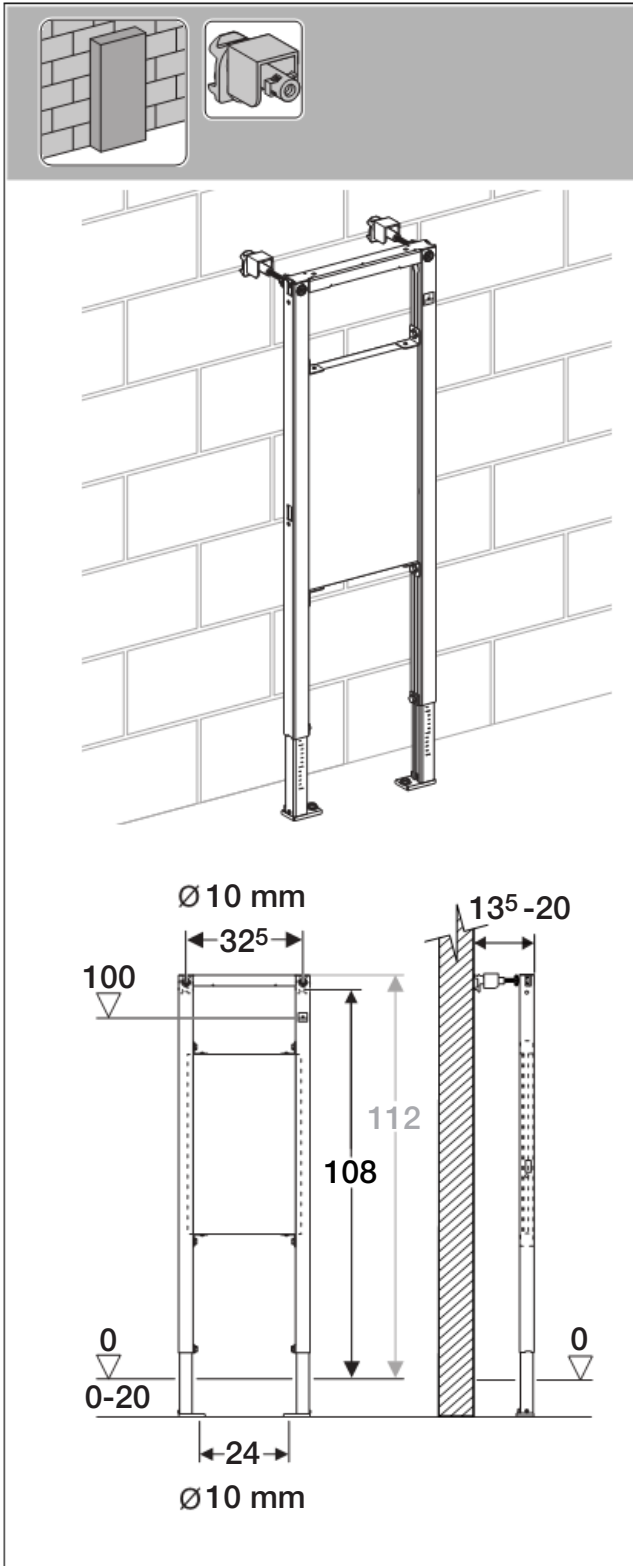

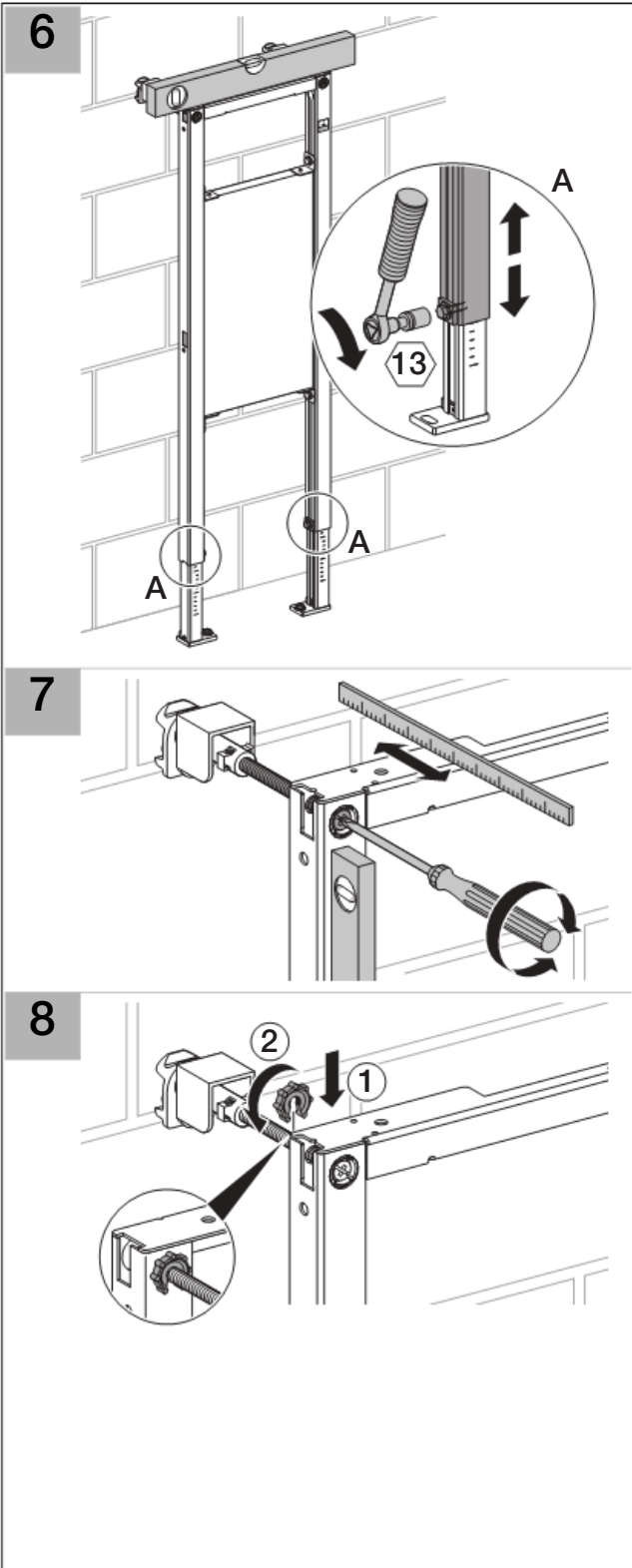
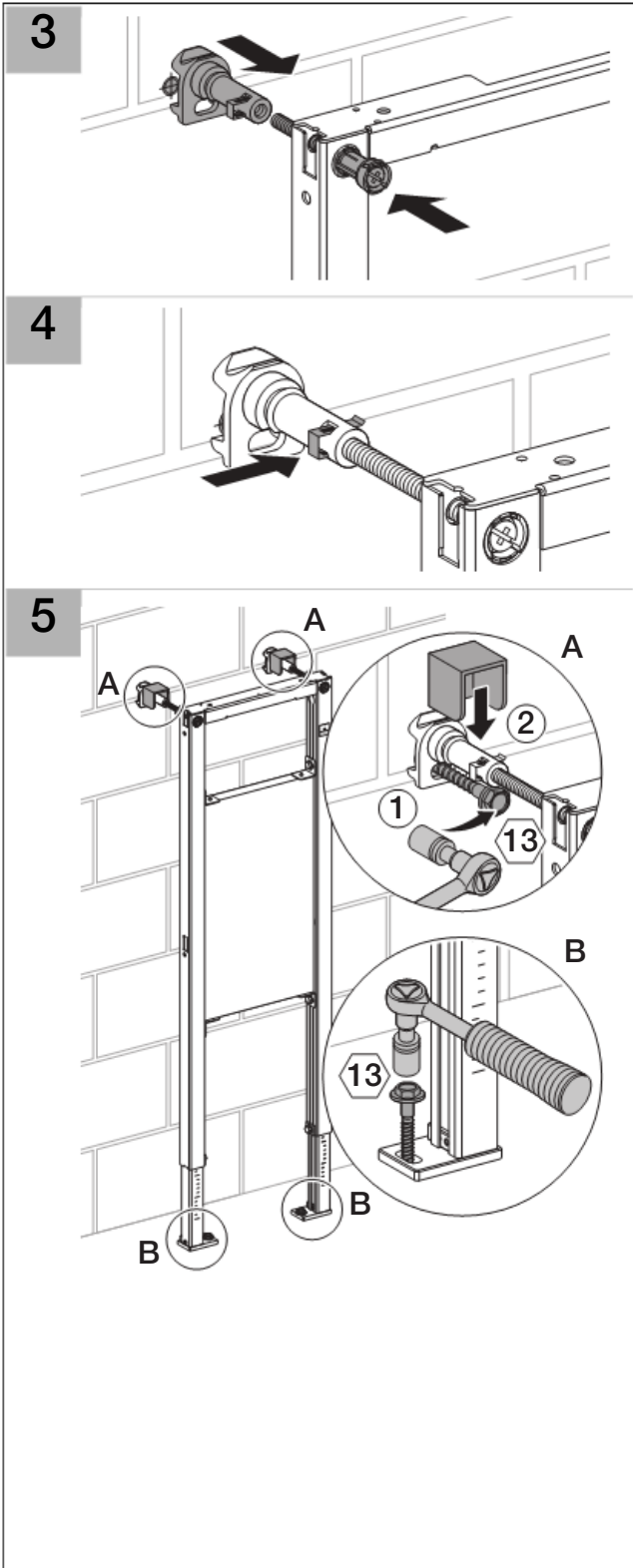

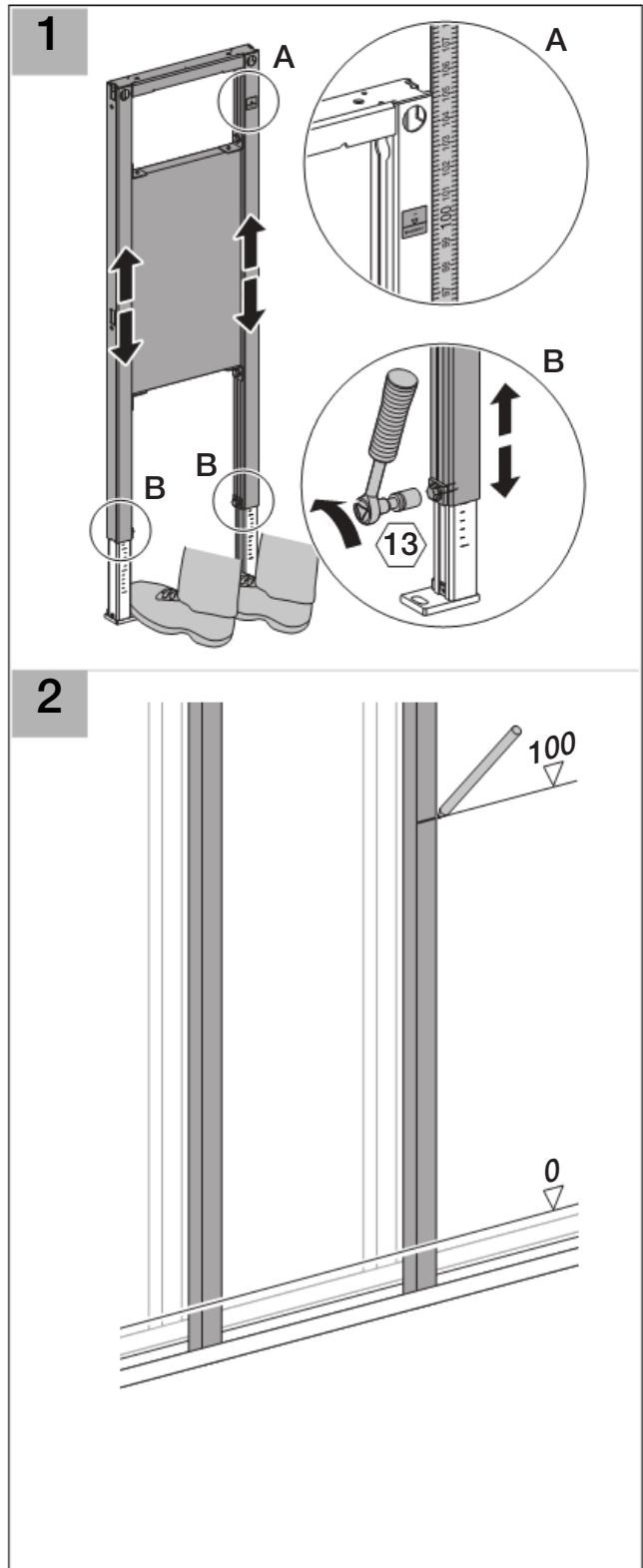
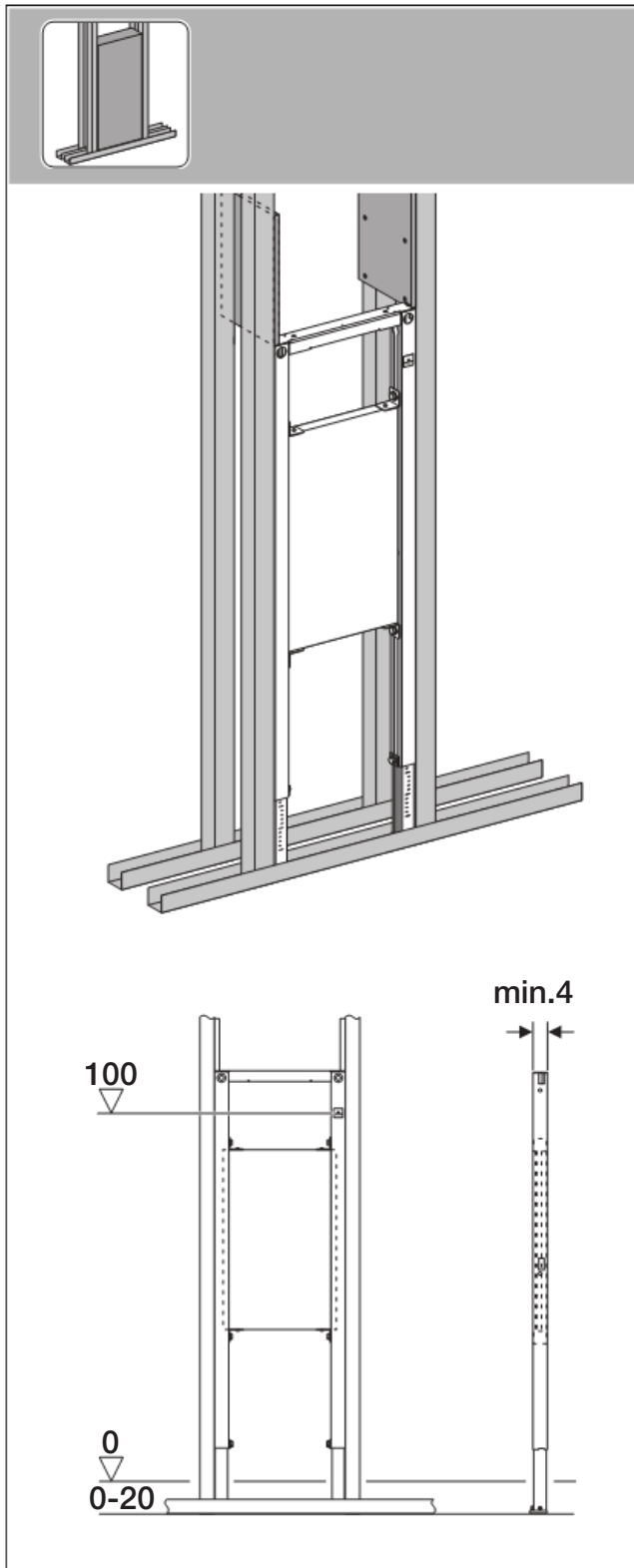

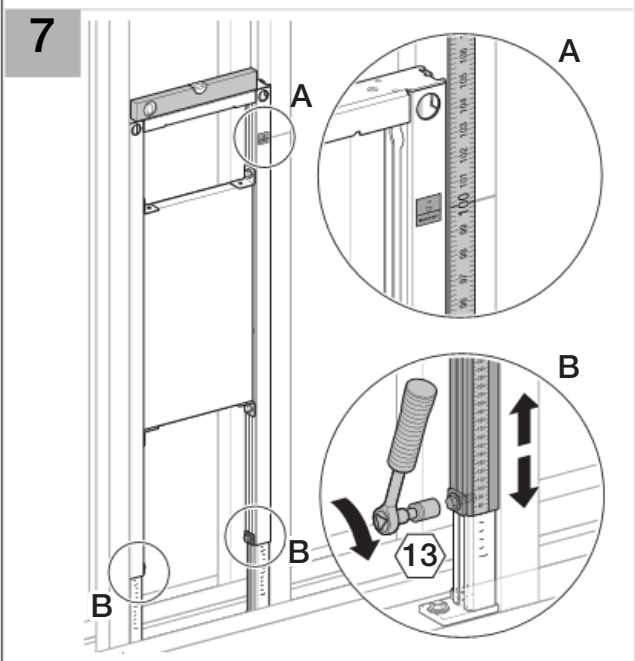
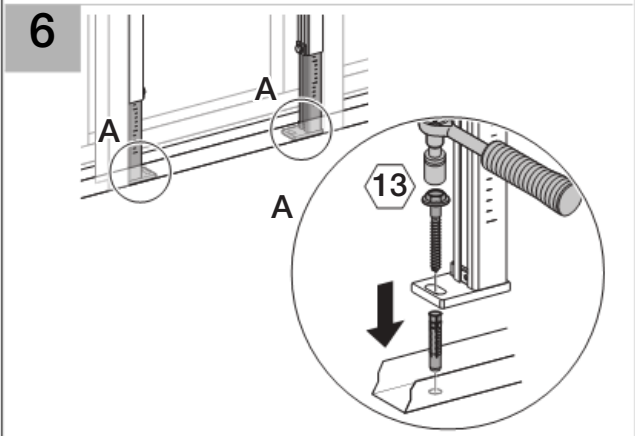
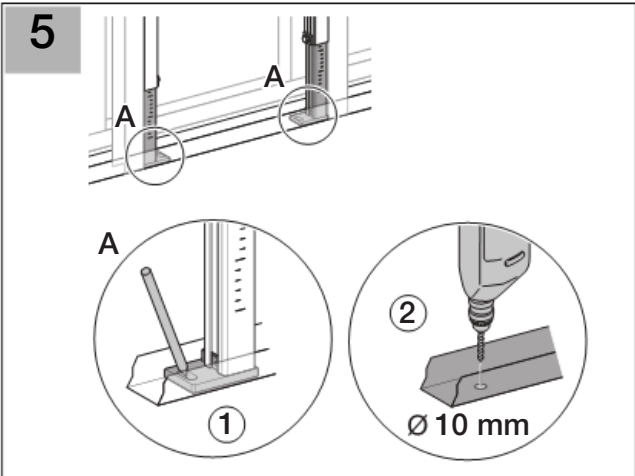
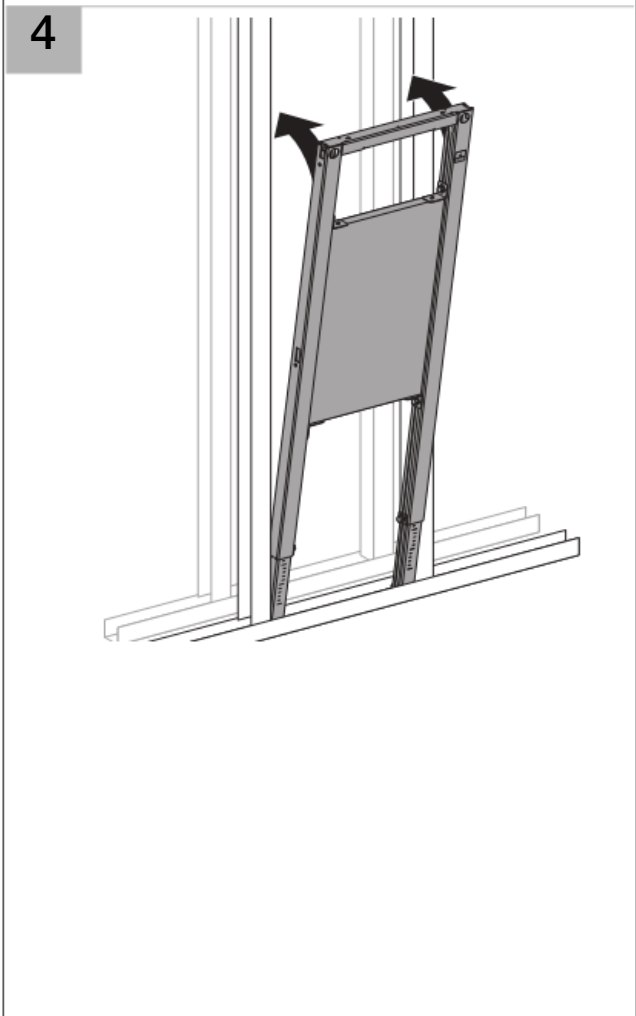
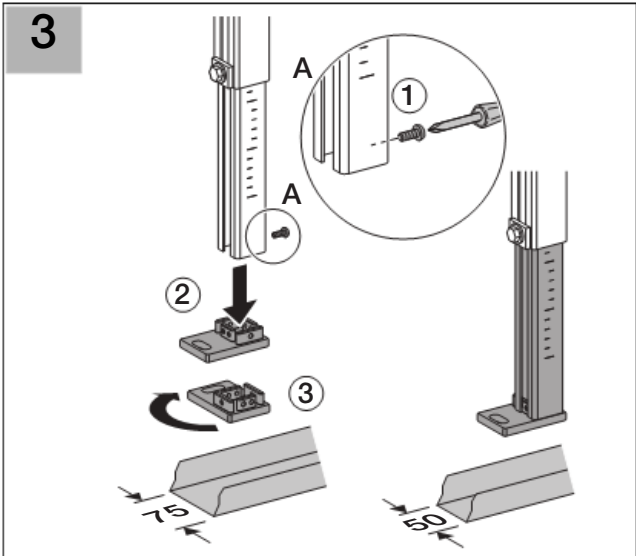

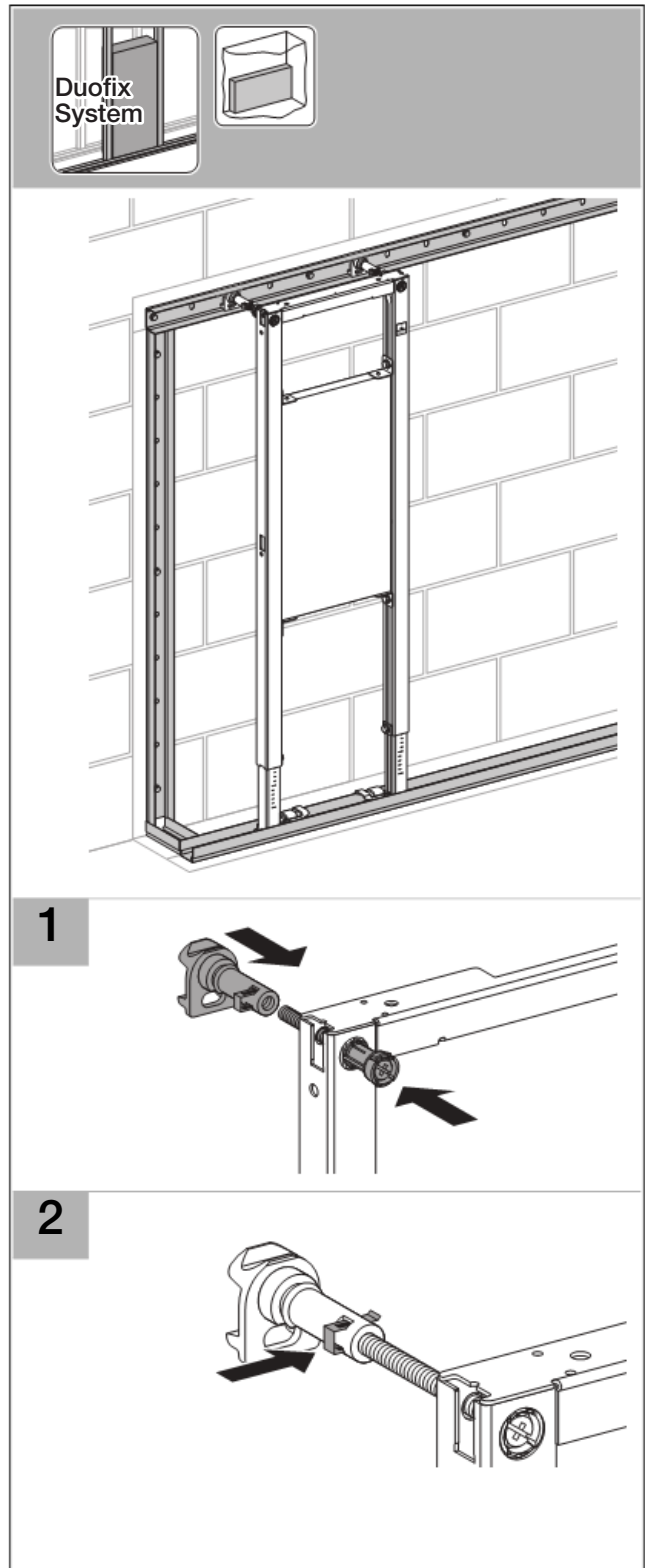
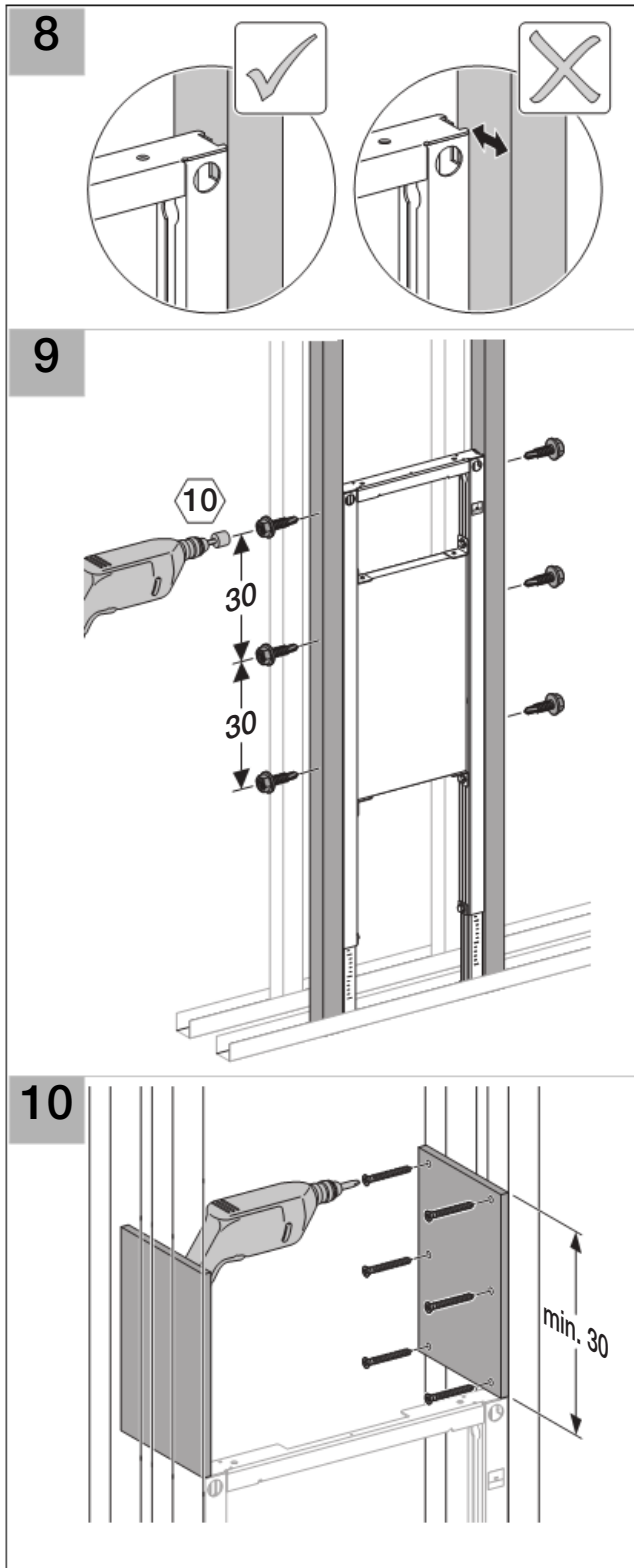

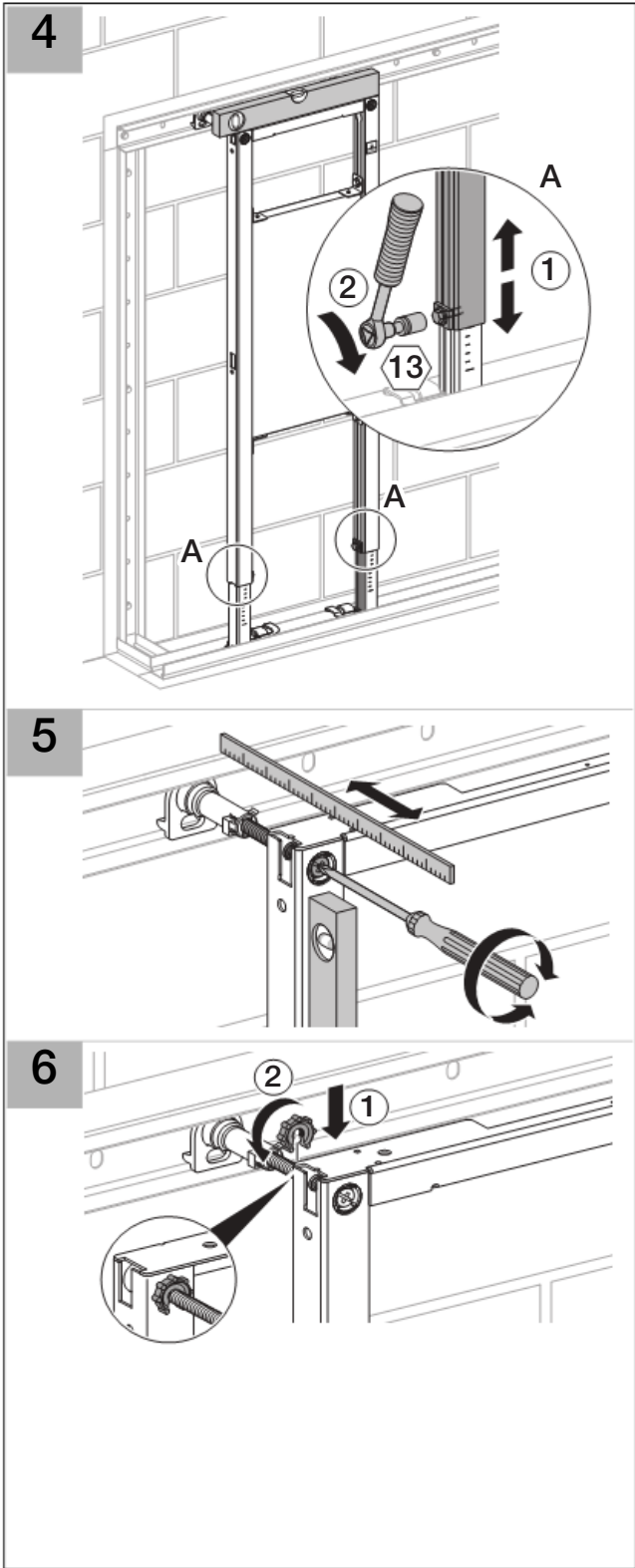
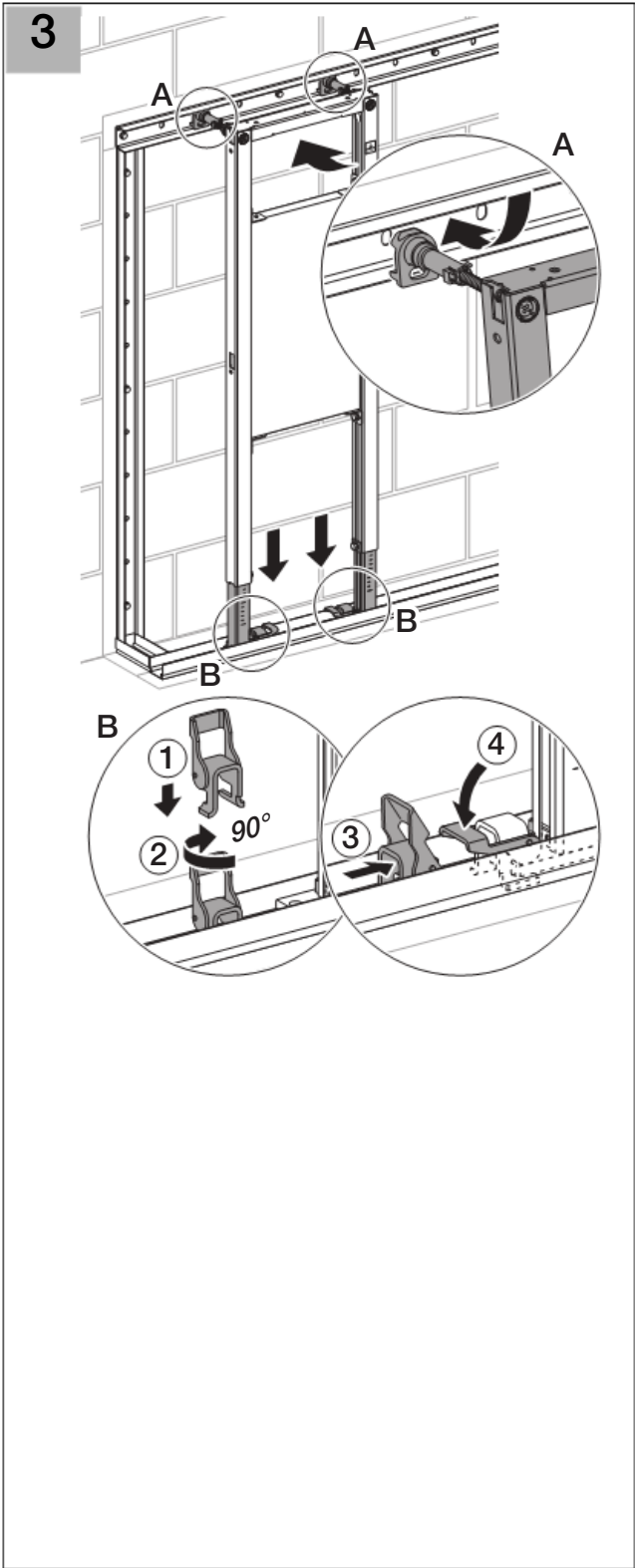

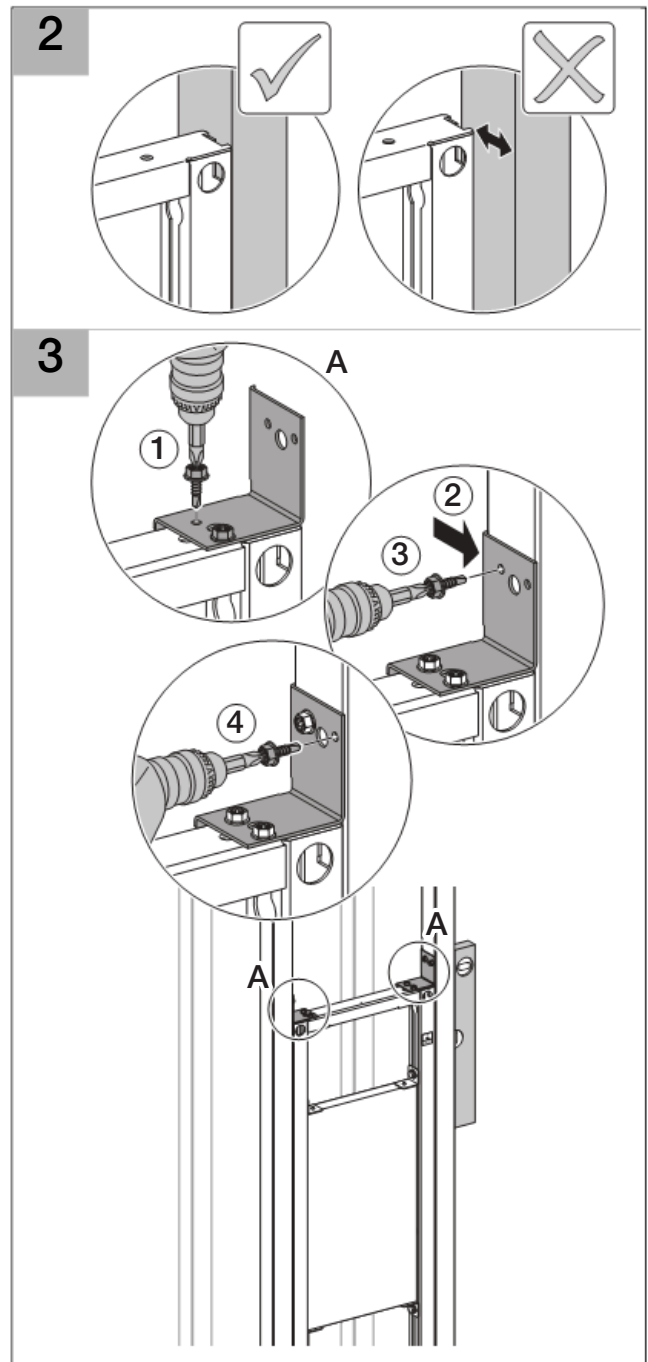
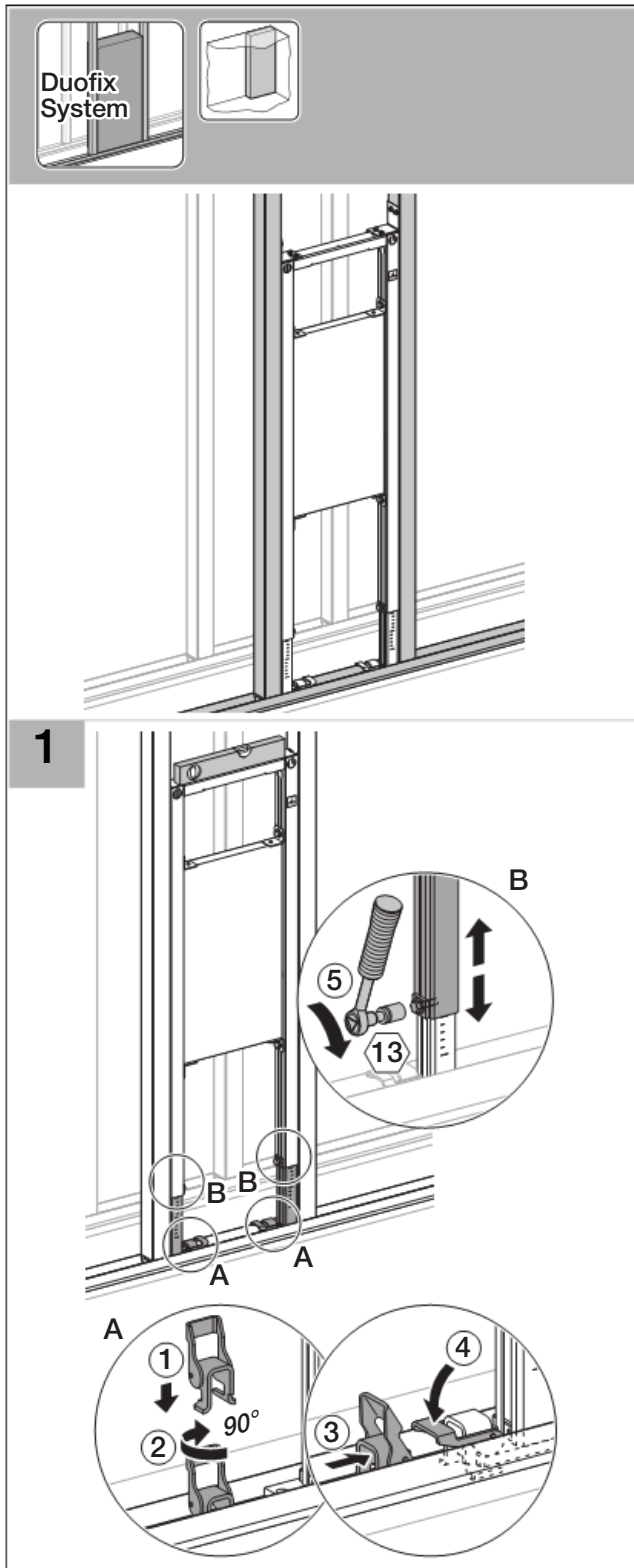

Geberit International AG
 Schachenstrasse 77
 CH-8645 Jona
www.geberit.com
dokumentation@geberit.com

D26047-001&BDC © 02-2008