

with design siphon DN32 LAUFEN 7498.0

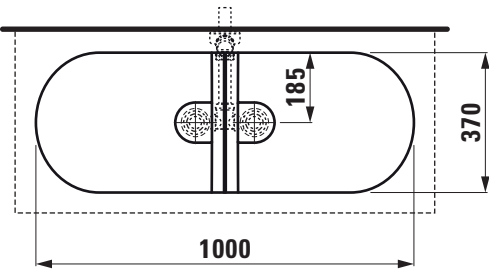

only for space saving siphon DN32 LAUFEN 89424.0
in combination with vanity unit 40905.3

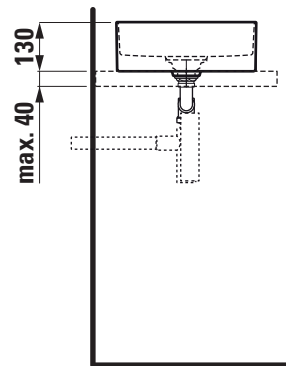
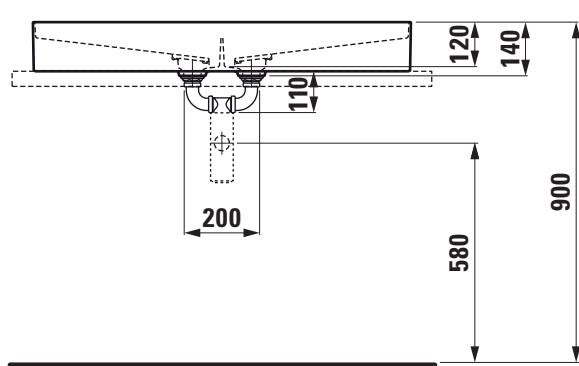