

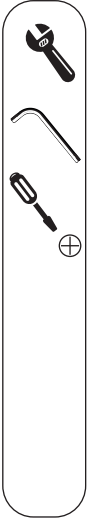

+

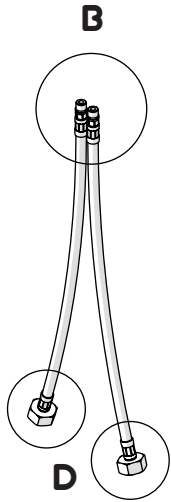

Not included / Non incluso / Non inclus / Nie zawarty / No incluido / Não incluido

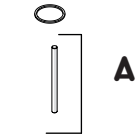

1

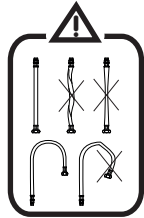
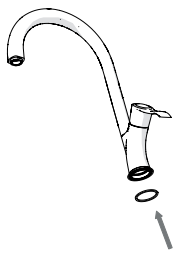

3

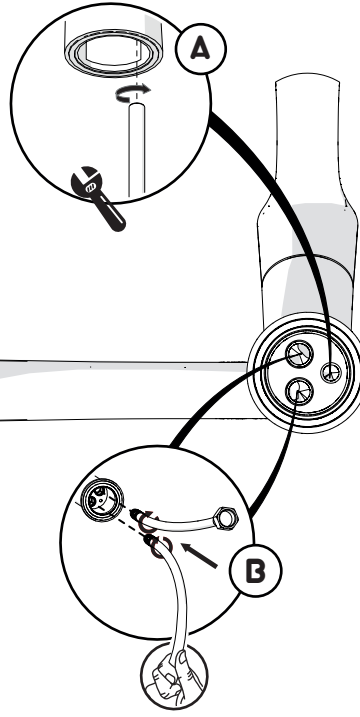

5

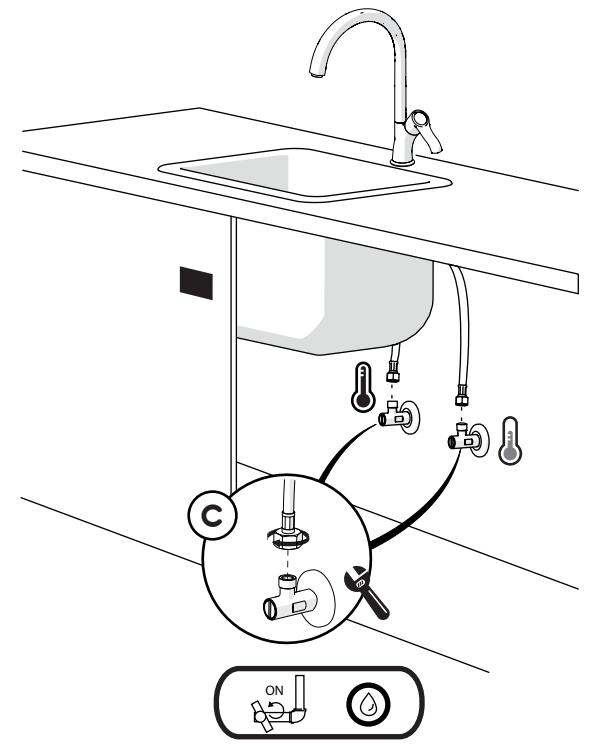

2

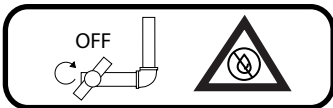
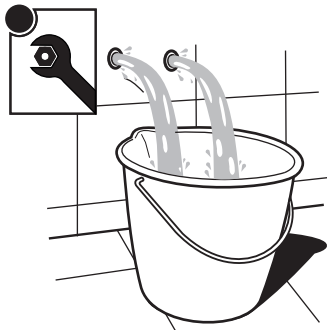
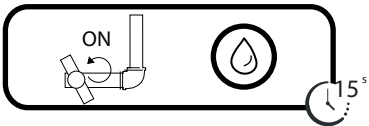

4

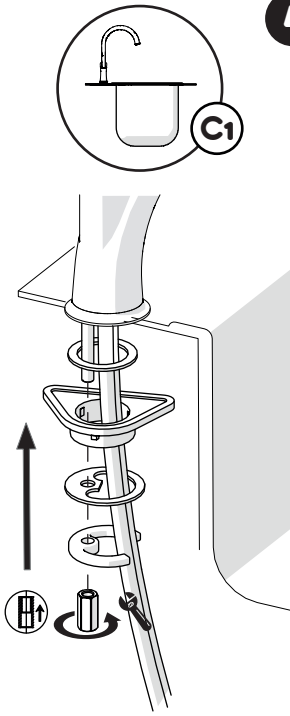
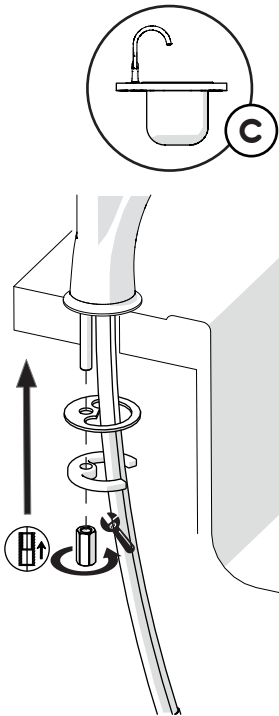

6

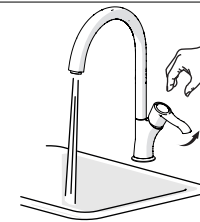

ON 50%



ON 100%

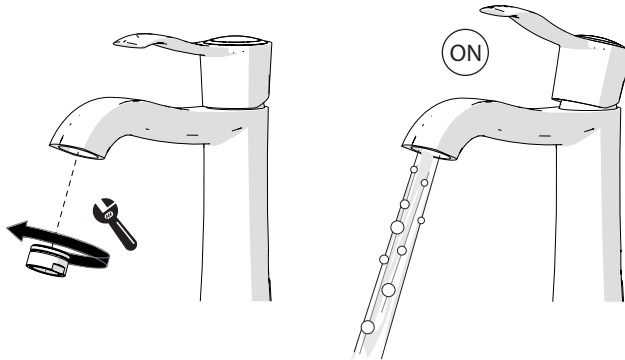
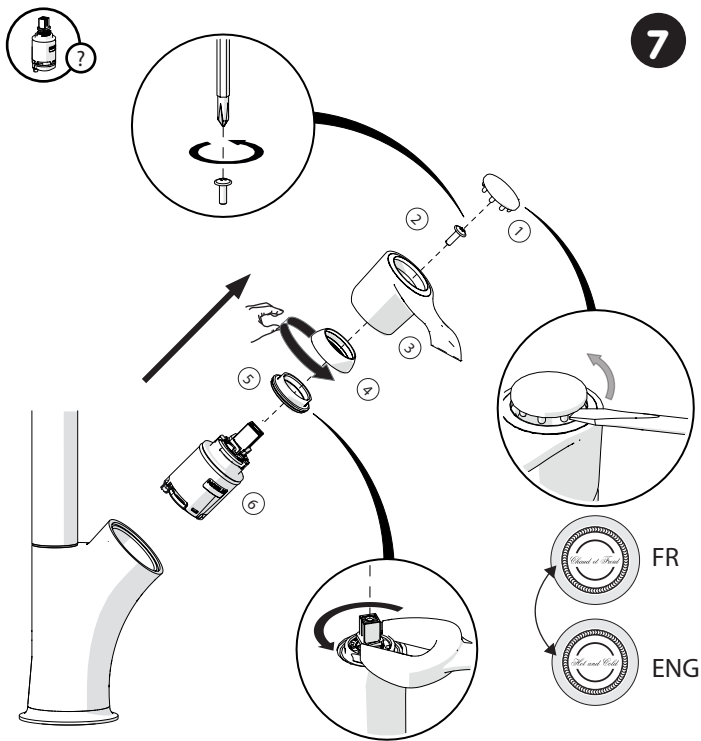

NOBILIA®
The Best Technology for Water



ISTRSI98113#---STD

REV01.11/2013

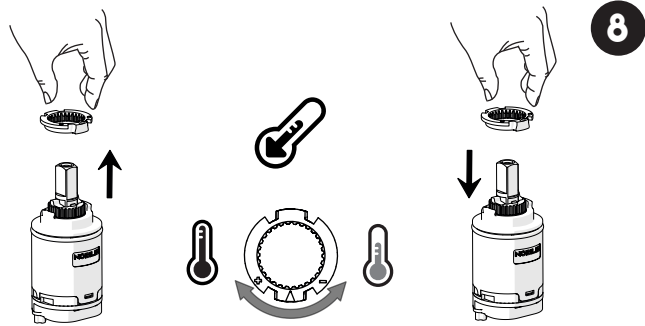

No limitation
of temperature

Partial limitation
of temperature

Maximum position
Only cold water

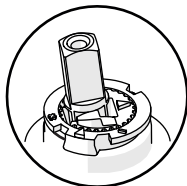
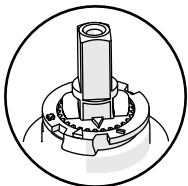
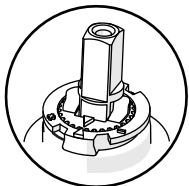

CLEANING

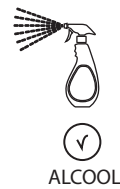
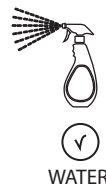
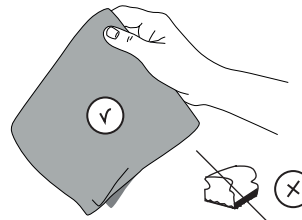

P
P
bar

0.5
MIN. **MAX**
10

5
T
°C

MAX
-80

65
45

