



Oras Nova

INSTALLATION AND MAINTENANCE GUIDE





4-16



17-19



20



21-24



25

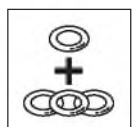

26-27



7460

I (ISO 3822) Oras lab.
 EN 1111
 100 - 1000 kPa
 0.19 l/s (Eco)
 0.27 l/s (300 kPa)
 165 kPa (0.2 l/s)
 max. +80°C

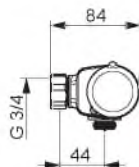
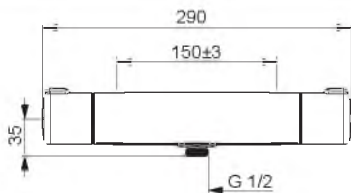

STF VTT-RTH-00085-17

1598 KIWA Sverige 1913



static.oras.com/7460

7460U

I (ISO 3822) Oras lab.
 EN 1111
 100 - 1000 kPa
 0.19 l/s (Eco)
 0.27 l/s (300 kPa)
 165 kPa (0.2 l/s)
 max. +80°C

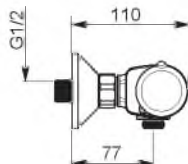
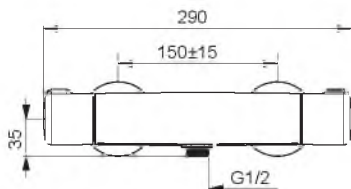

1598 KIWA Sverige 1913



static.oras.com/7460U

7460X

I (ISO 3822) Oras lab.
 EN 1111
 100 - 1000 kPa
 0.19 l/s (Eco)
 165 kPa (0.2 l/s)
 max. +80°C

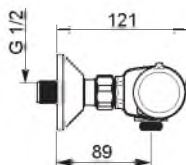
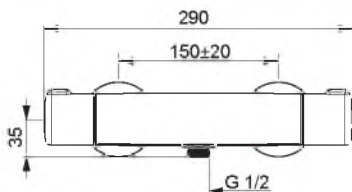

static.oras.com/7460X

7461

I (ISO 3822) Oras lab.
 EN 1111
 100 - 1000 kPa
 0.19 l/s (Eco)
 0.28 l/s (300 kPa)
 165 kPa (0.2 l/s)
 max. +80°C

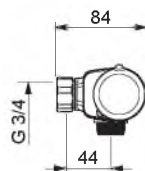
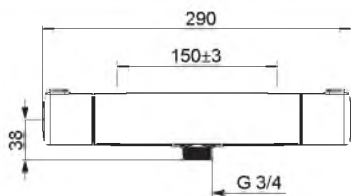

STF VTT-RTH-00085-17



static.oras.com/7461

7471

I (ISO 3822) Oras lab.
 EN 1111
 100 - 1000 kPa
 0.19 l/s (Eco)
 0.27 l/s (300 kPa)
 165 kPa (0.2 l/s)
 max. +80°C

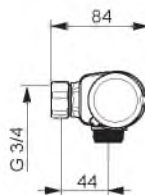

STF VTT-RTH-00085-17



static.oras.com/7471

7484

I (ISO 3822) Oras lab.
 EN 1111
 100 - 1000 kPa
 0.18 l/s (Eco)
 0.26 l/s (300 kPa)
 180 kPa (0.2 l/s)
 max. +80°C

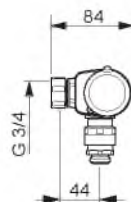
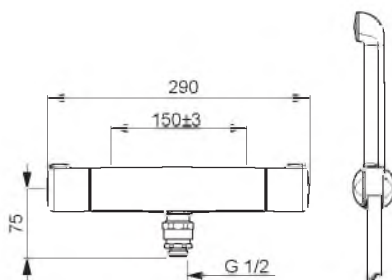

STF VTT-RTH-00085-17



static.oras.com/7484



7464

I (ISO 3822) Oras lab.
EN 1111
100 - 1000 kPa
0.19 l/s (Eco)
0.27 l/s (300 kPa)
165 kPa (0.2 l/s)
max. +80°C

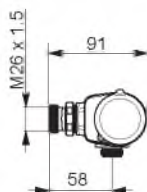
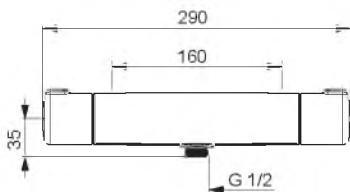

static.oras.com/7464

7466

I (ISO 3822) Oras lab.
EN 1111
100 - 1000 kPa
0.18 l/s (Eco)
0.26 l/s (300 kPa)
180 kPa (0.2 l/s)
max. +80°C

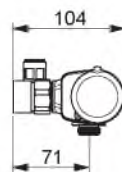
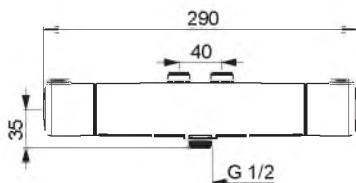

static.oras.com/7466

7470X

I (ISO 3822) Oras lab.
EN 1111
100 - 1000 kPa
0.19 l/s (Eco)
0.27 l/s (300 kPa)
165 kPa (0.2 l/s)
max. +80°C

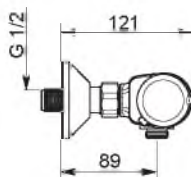
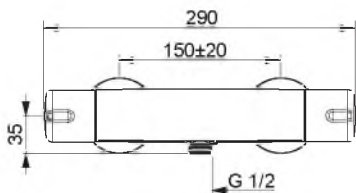

static.oras.com/7470X

7470U

I (ISO 3822) Oras lab.
 EN 1111
 100 - 1000 kPa
 0.19 l/s (Eco)
 0.27 l/s (300 kPa)
 165 kPa (0.2 l/s)
 max. +80°C

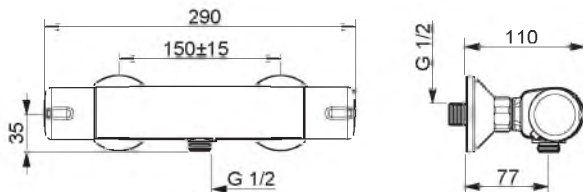

1598 KIWA Sverige 1913



static.oras.com/7470U

7446X

I (ISO 3822) Oras lab.
 EN 1111
 100 - 1000 kPa
 0.16 l/s (Eco)
 0.23 l/s (300 kPa)
 230 kPa (0.2 l/s)
 max. +80°C

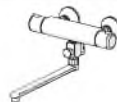
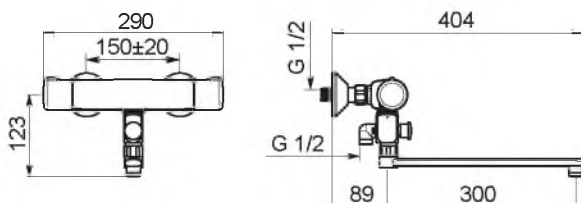

static.oras.com/7446X

7447X

I (ISO 3822) Oras lab.
 EN 1111
 100 - 1000 kPa
 0.16 l/s (Eco)
 0.23 l/s (300 kPa)
 230 kPa (0.2 l/s)
 max. +80°C

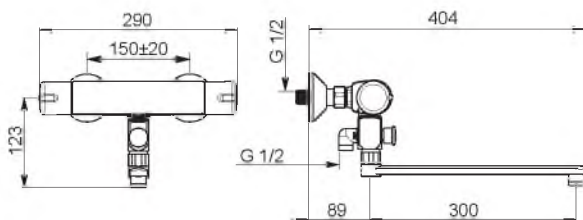

static.oras.com/7447X



7469

EN 1111

100 - 1000 kPa

0.27 l/s (300 kPa)

165 kPa (0.2 l/s)

max. +80°C

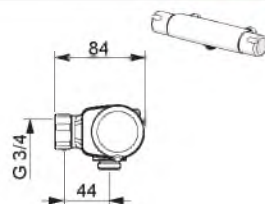
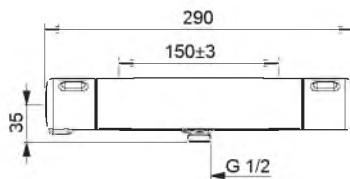

static.oras.com/7469

7420

I (ISO 3822) Oras lab.

EN 1111

100 - 1000 kPa

0.15 l/s (300 kPa w/Controller)

150 kPa (0.2 l/s)

max. +80°C

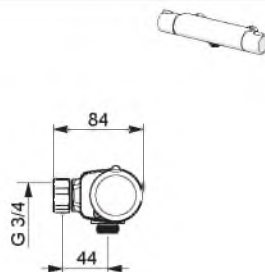
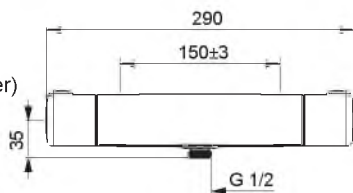

static.oras.com/7420

7462

II (ISO 3822) Oras lab.

EN 1111

100 - 1000 kPa

0.16 l/s (Eco)

0.33 l/s (300 kPa)

230 kPa (0.2 l/s)

300 kPa (0.3 l/s)

max. +80°C

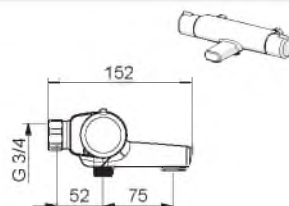
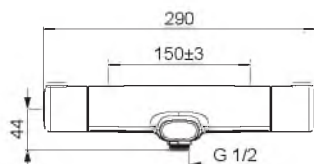

static.oras.com/7462



1598 KIWA Sverige 1913



7462G

I (ISO 3822)
 EN 1111
 100 - 1000 kPa
 0.16 l/s (Eco)
 0.23 l/s (300 kPa)
 230 kPa (0.2 l/s)
 max. +80°C

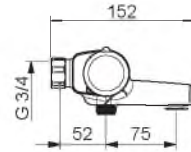
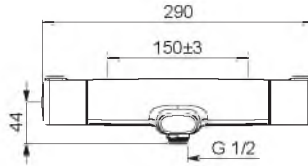

STF VTT-RTH-00085-17



static.oras.com/7462G

7462U

I (ISO 3822) Oras lab.
 EN 1111
 100 - 1000 kPa
 0.16 l/s (Eco)
 0.33 l/s (300 kPa)
 230 kPa (0.2 l/s)
 300 kPa (0.3 l/s)
 max. +80°C

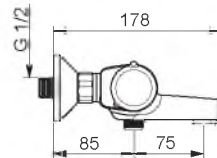
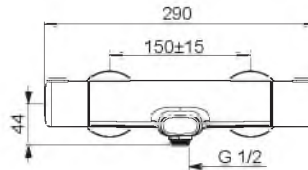

 1598 KIWA Sverige 1913



static.oras.com/7462U

7443

II (ISO 3822) Oras lab.
 EN 1111
 100 - 1000 kPa
 0.16 l/s (Eco)
 0.33 l/s (300 kPa)
 230 kPa (0.2 l/s)
 300 kPa (0.3 l/s)
 max. +80°C

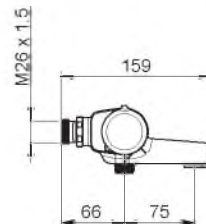
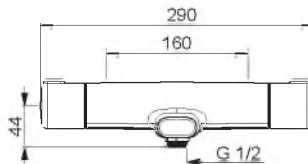

static.oras.com/7443



7445

II (ISO 3822) Oras lab.
EN 1111
100 - 1000 kPa
0.15 l/s (Eco)
0.3 l/s (300 kPa)
250 kPa (0.2 l/s)
300 kPa (0.3 l/s)
max. +80°C

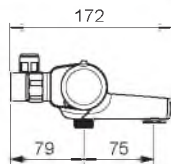
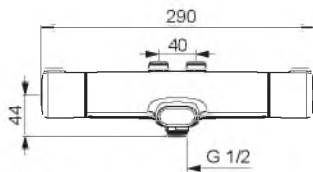

static.oras.com/7445

7442U

I (ISO 3822) Oras lab.
EN 1111
100 - 1000 kPa
0.18 l/s (Eco)
0.3 l/s (300 kPa)
180 kPa (0.2 l/s)
300 kPa (0.3 l/s)
max. +80°C

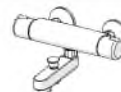
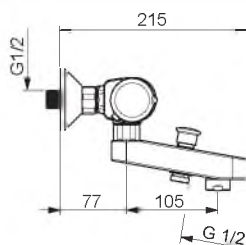
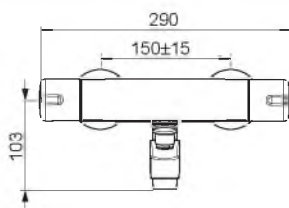

static.oras.com/7442U

7460L

I (ISO 3822) Oras lab.
EN 1111
50 - 1000 kPa
0.19 l/s (Eco)
0.27 l/s (300 kPa)
max. +80°C

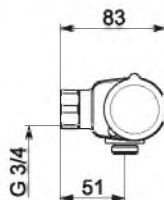
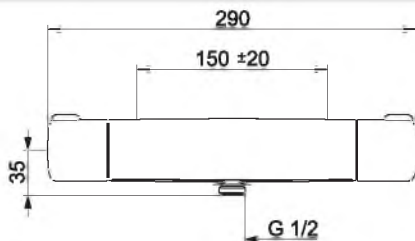

static.oras.com/7460L

7464L

I (ISO 3822) Oras lab.
 EN 1111
 50 - 1000 kPa
 0.19 l/s (Eco)
 0.27 l/s (300 kPa)
 max. +80°C

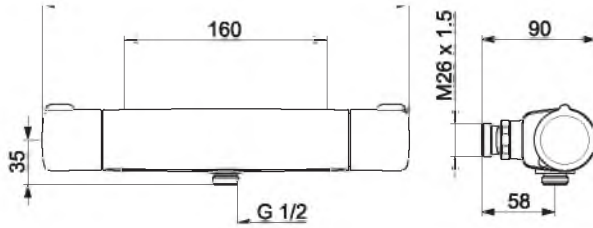

static.oras.com/7464L

7412, (7460+530)

I (ISO 3822) Oras lab.
 EN 1111
 100 - 1000 kPa
 0.12 l/s (300 kPa w/Controller)
 200 kPa (0.2 l/s)
 max. +80°C

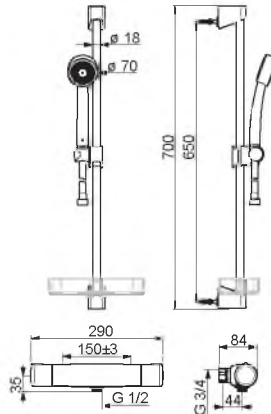

static.oras.com/7412

7425, (7460+520)

I (ISO 3822) Oras lab.
 EN 1111
 100 - 1000 kPa
 0.2 l/s (Eco)
 0.28 l/s (300 kPa)
 155 kPa (0.2 l/s)
 max. +80°C

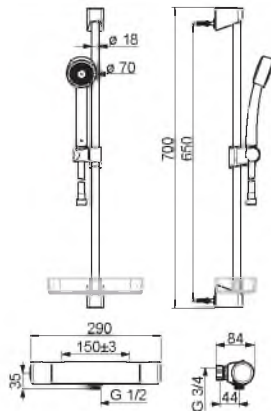

static.oras.com/7425



7422, (7464+530)

I (ISO 3822) Oras lab.
 EN 1111
 100 - 1000 kPa
 0.12 l/s (300 kPa w/Controller)
 200 kPa (0.2 l/s)
 max. +80°C

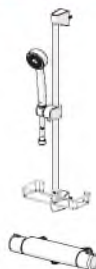
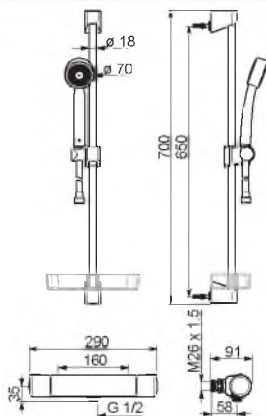

static.oras.com/7422

7427, (7464+520)

I (ISO 3822) Oras lab.
 EN 1111
 100 - 1000 kPa
 0.2 l/s (Eco)
 0.28 l/s (300 kPa)
 155 kPa (0.2 l/s)
 max. +80°C

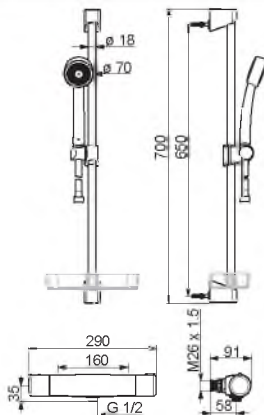

static.oras.com/7427

7432, (7466+530)

I (ISO 3822) Oras lab.
 EN 1111
 100 - 1000 kPa
 0.12 l/s (300 kPa w/Controller)
 200 kPa (0.2 l/s)
 max. +80°C

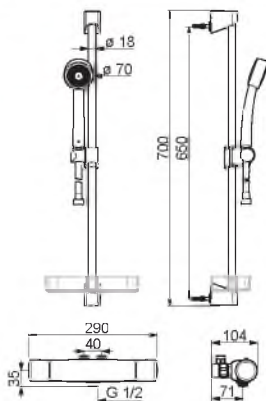

static.oras.com/7432

7424, (7466+520)

I (ISO 3822) Oras lab.
 EN 1111
 100 - 1000 kPa
 0.19 l/s (Eco)
 0.27 l/s (300 kPa)
 160 kPa (0.2 l/s)
 max. +80°C

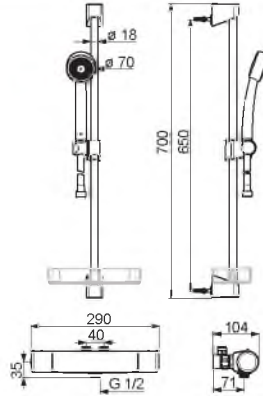

static.oras.com/7424

7495, (7461+261033+520)

I (ISO 3822) Oras lab.
 EN 1111
 100 - 1000 kPa
 0.2 l/s (Eco)
 0.28 l/s (300 kPa)
 155 kPa (0.2 l/s)
 max. +80°C

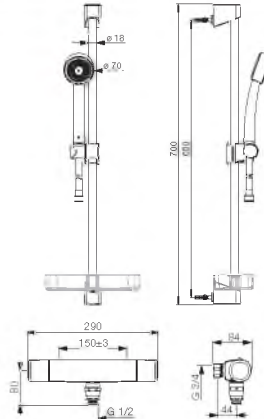

static.oras.com/7495

STF VTT-RTH-00085-17

7455, (7461+261033+544)

I (ISO 3822) Oras lab.
 EN 1111
 100 - 1000 kPa
 0.2 l/s (Eco)
 0.28 l/s (300 kPa)
 160 kPa (0.2 l/s)
 max. +80°C

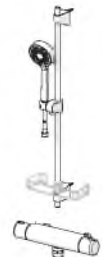
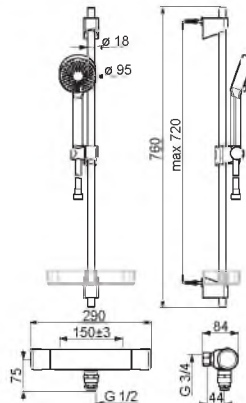

static.oras.com/7455

STF VTT-RTH-00085-17



7448, (7462G+261031+520)

I (ISO 3822) Oras lab.

EN 1111

100 - 1000 kPa

0.17 l/s (Eco)

0.24 l/s (300 kPa)

220 kPa (0.2 l/s)

max. +80°C

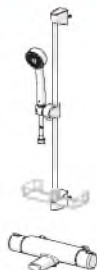
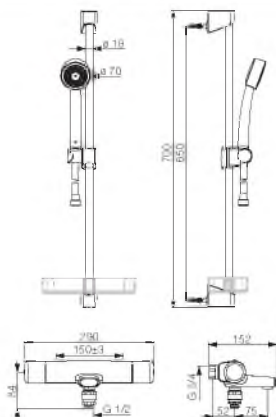

static.oras.com/7448

STF VTT-RTH-00085-17

7453, (7462G+544)

I (ISO 3822) Oras lab.

EN 1111

100 - 1000 kPa

0.17 l/s (Eco)

0.26 l/s (300 kPa)

200 kPa (0.2 l/s)

max. +80°C

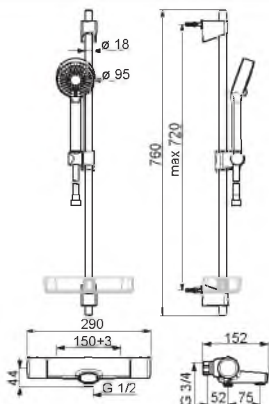

static.oras.com/7453

STF VTT-RTH-00085-17

7452U, (7460U+530)

I (ISO 3822) Oras lab.

EN 1111

100 - 1000 kPa

0.12 l/s (300 kPa w/Controller)

max. +80°C

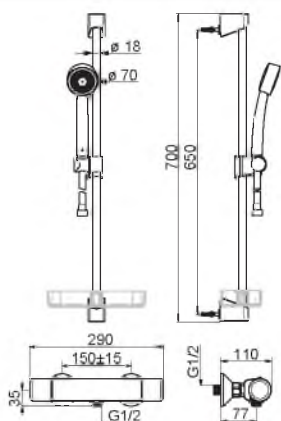

static.oras.com/7452U

7429, (7460+500)

I (ISO 3822)
 EN 1111
 100 - 1000 kPa
 0.12 l/s (300 kPa w/Controller)
 max. +80°C

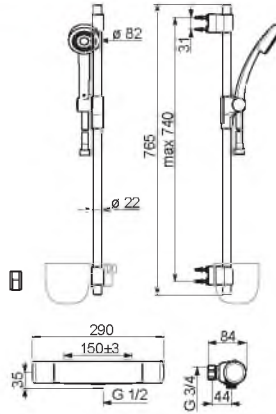

static.oras.com/7429

7413, (7460+544)

I (ISO 3822) Oras lab.
 EN 1111
 100 - 1000 kPa
 0.16 l/s (Eco)
 0.24 l/s (300 kPa)
 210 kPa (0.2 l/s)
 max. +80°C

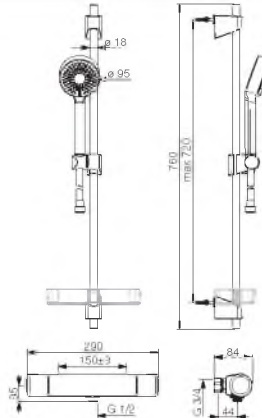

static.oras.com/7413

7413U, (7460U+544)

I (ISO 3822) Oras lab.
 EN 1111
 100 - 1000 kPa
 0.16 l/s (Eco)
 0.24 l/s (300 kPa)
 210 kPa (0.2 l/s)
 max. +80°C

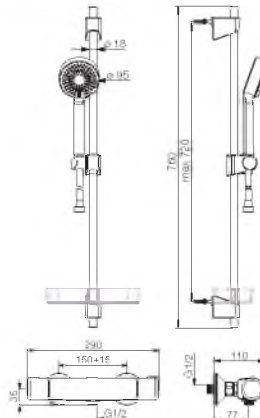

static.oras.com/7413U



7414, (7462+544)

II (ISO 3822) Oras lab.
 EN 1111
 100 - 1000 kPa
 0.14 l/s (Eco)
 0.33 l/s (300 kPa)
 300 kPa (0.3 l/s)
 max. +80°C

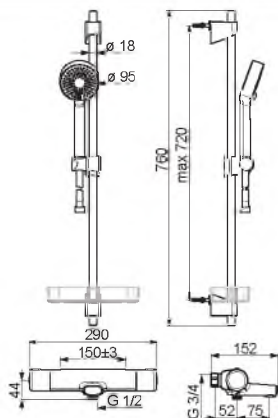

static.oras.com/7414

7414U, (7462U+544)

I (ISO 3822) Oras lab.
 EN 1111
 100 - 1000 kPa
 0.14 l/s (Eco)
 0.33 l/s (300 kPa)
 300 kPa (0.3 l/s)
 max. +80°C

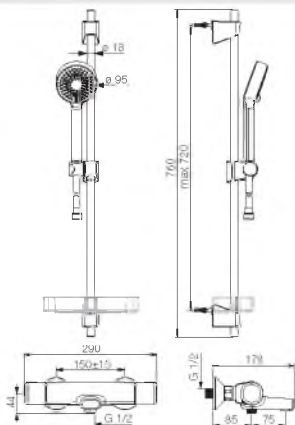

static.oras.com/7414U

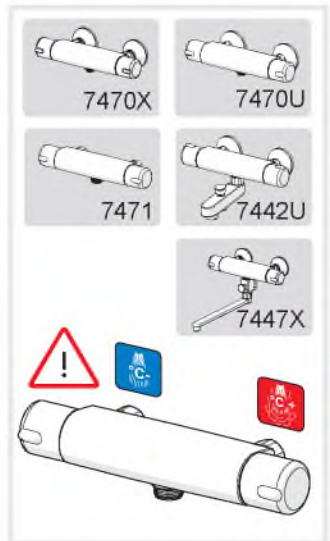
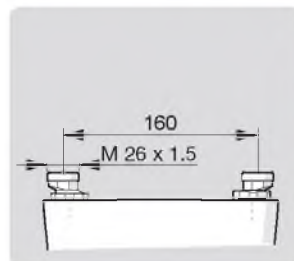
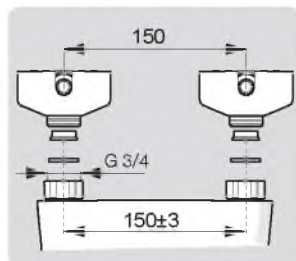
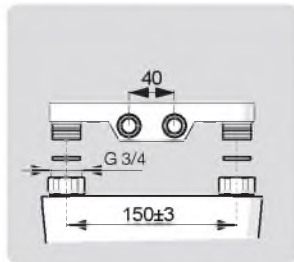
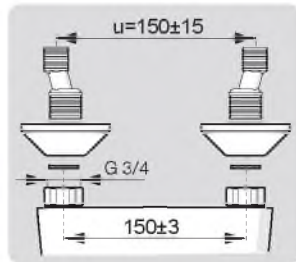
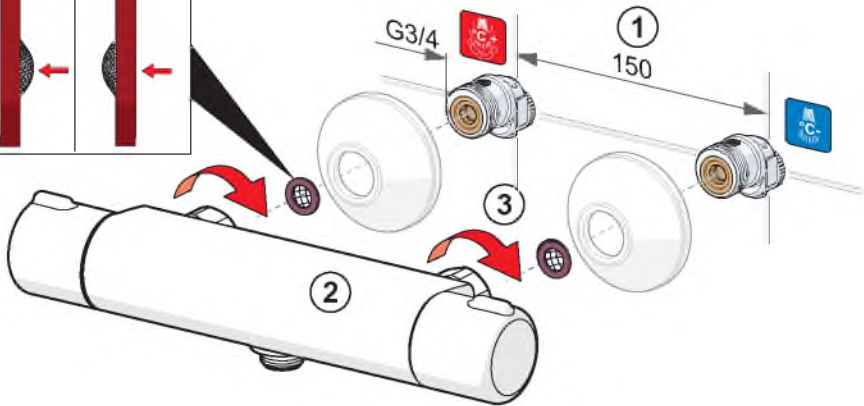
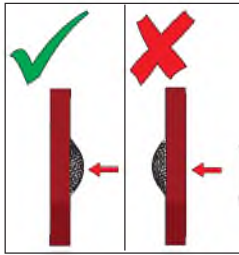
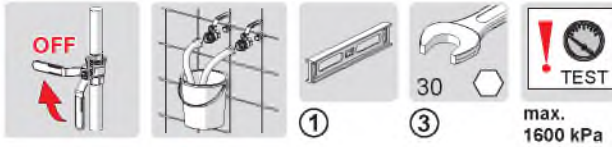

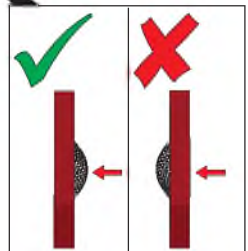
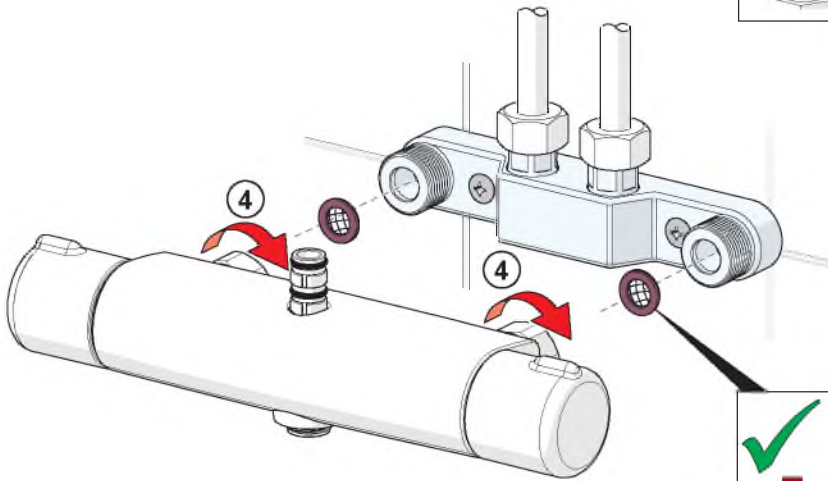
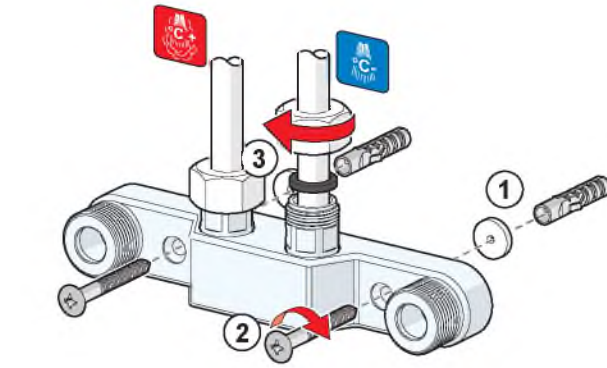
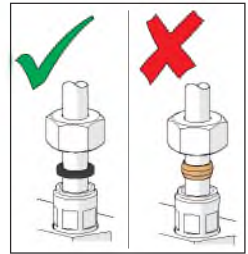
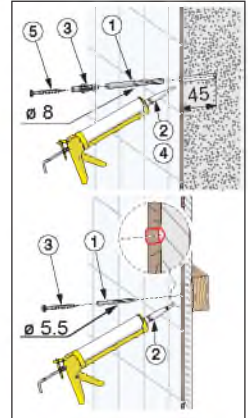
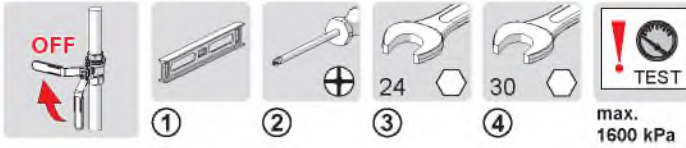

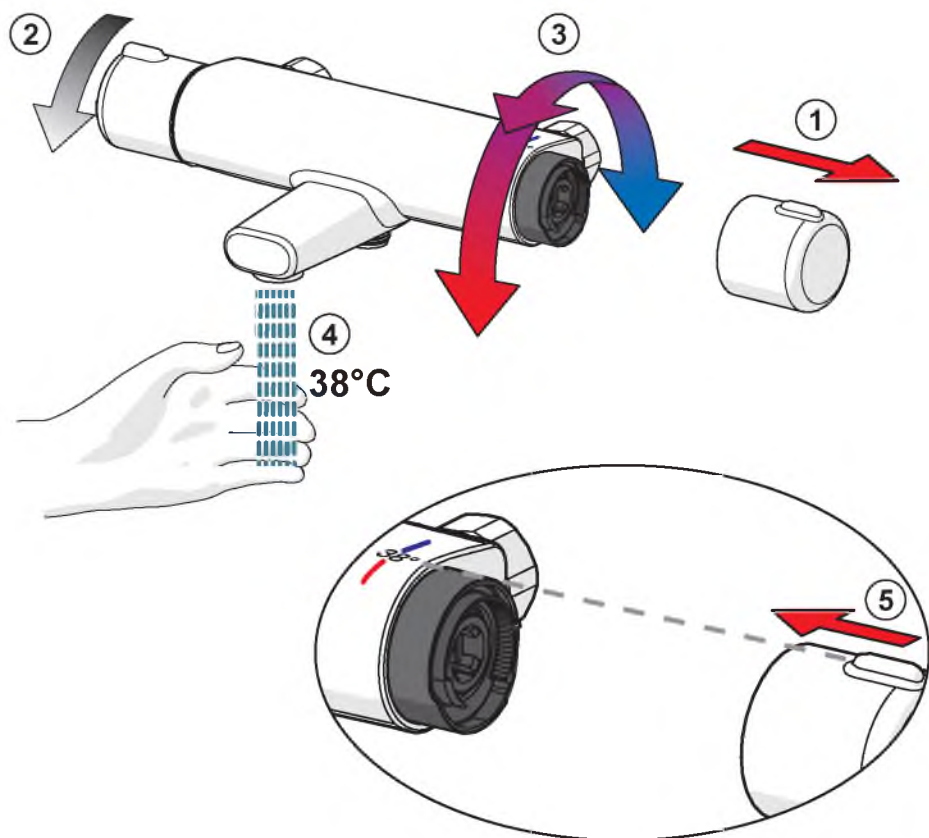

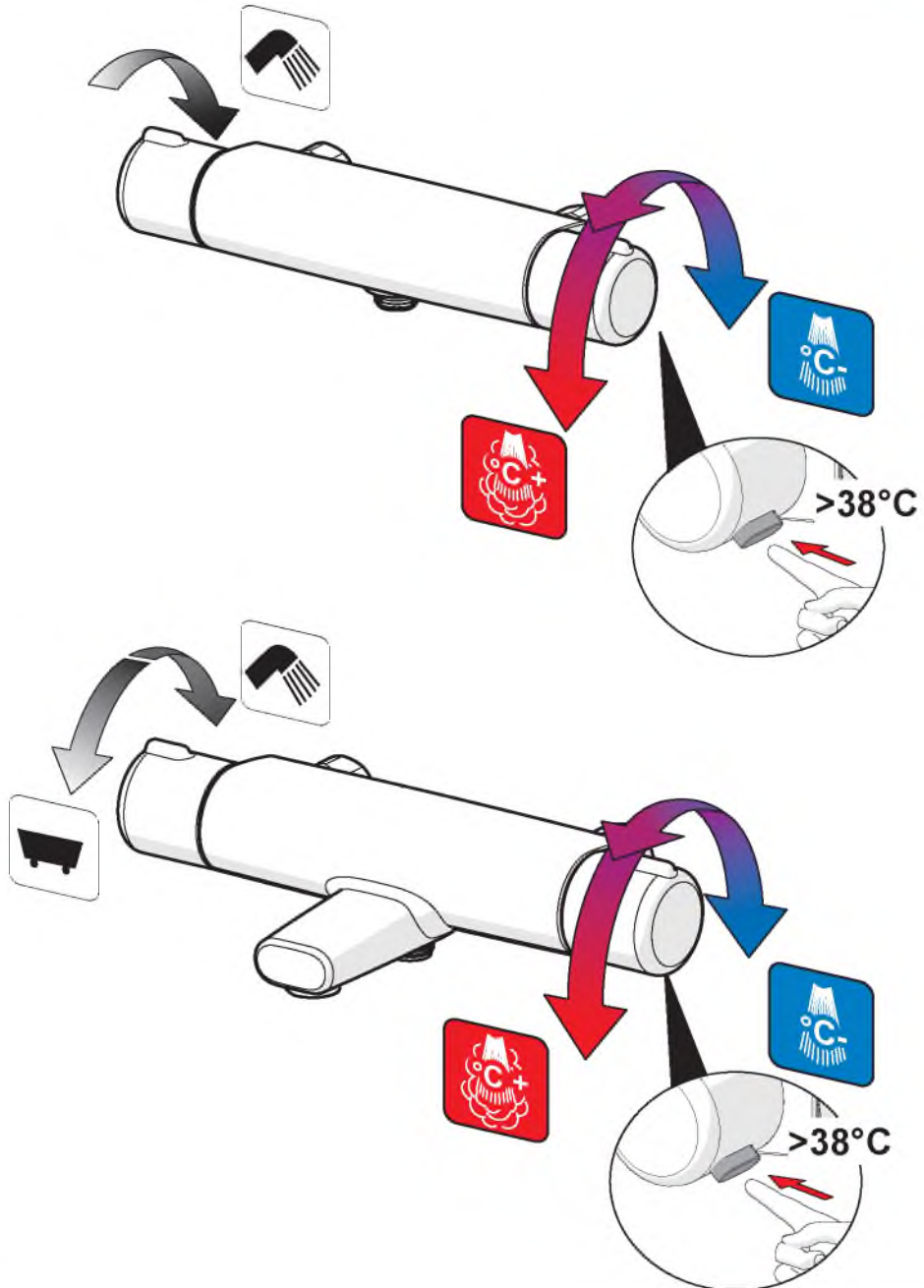

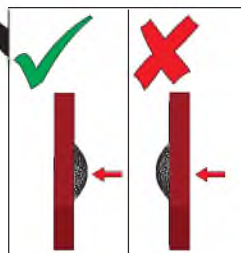
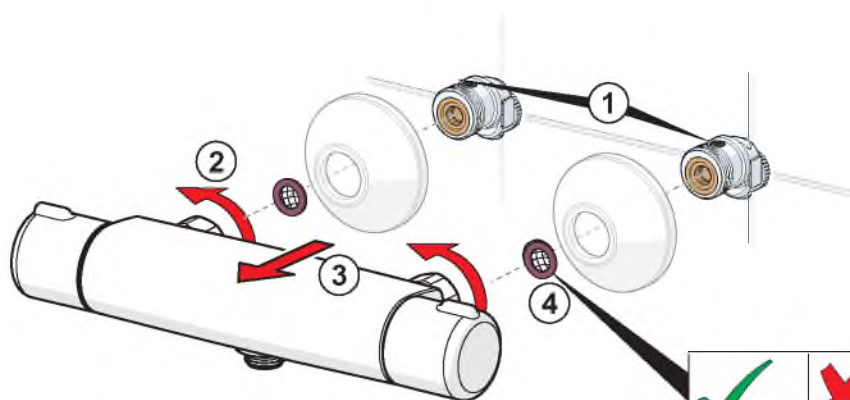
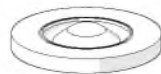

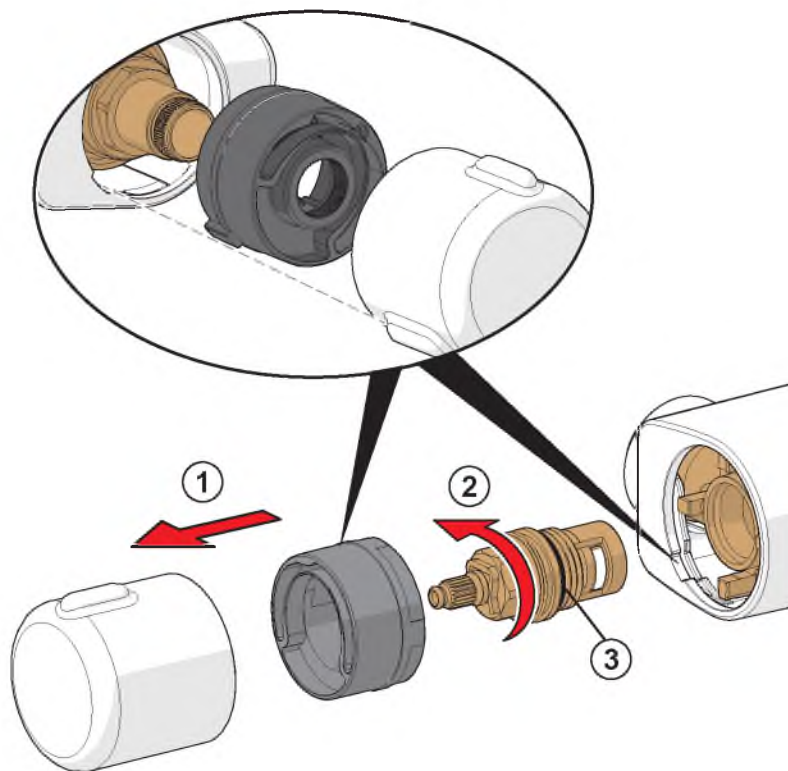

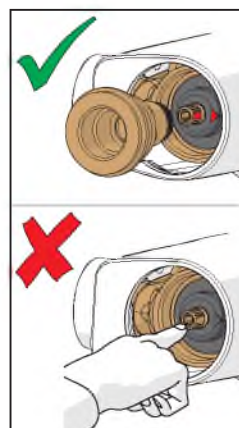
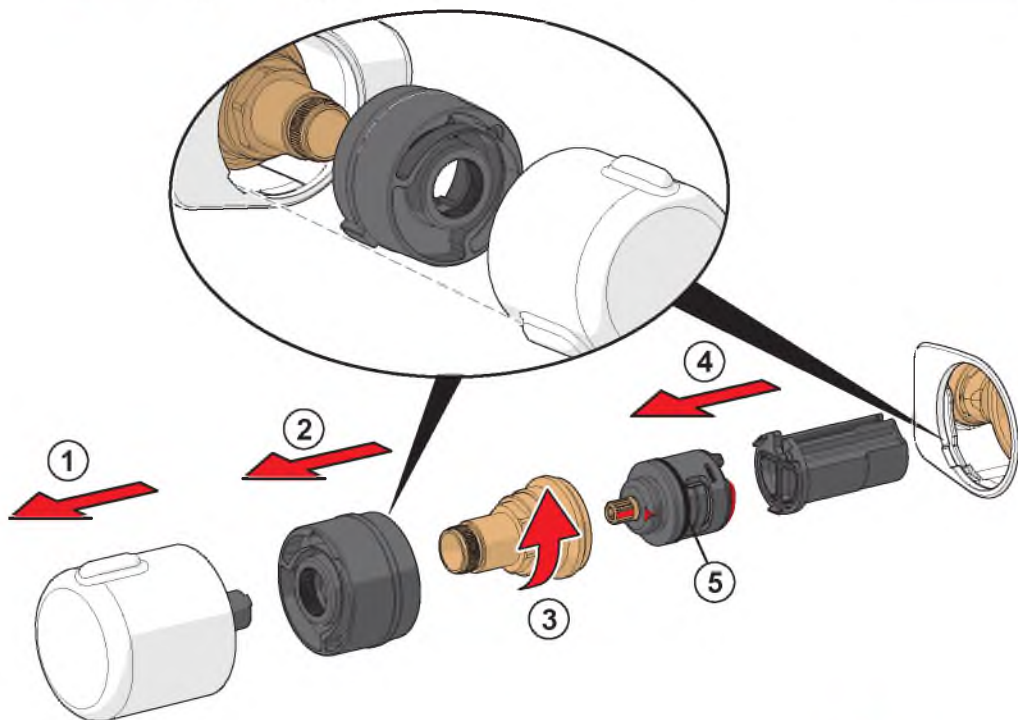

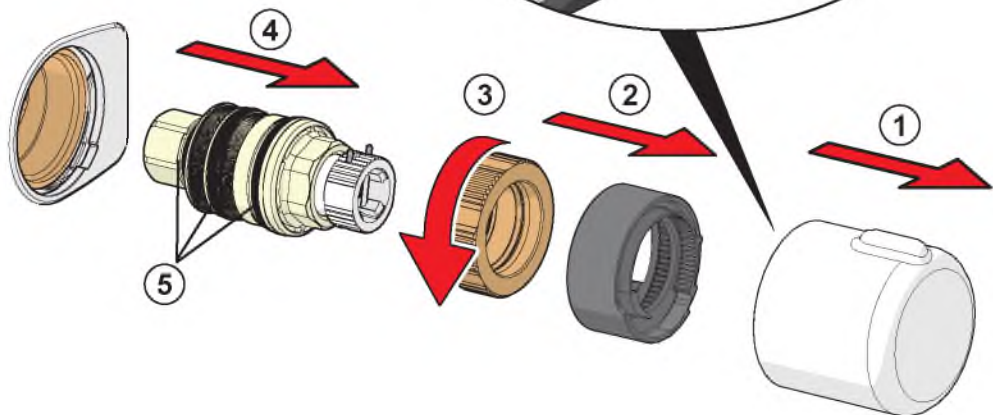
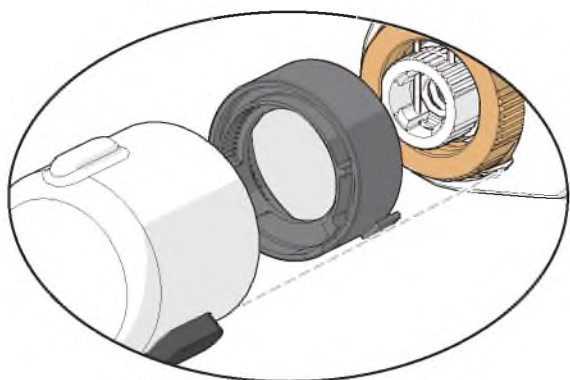

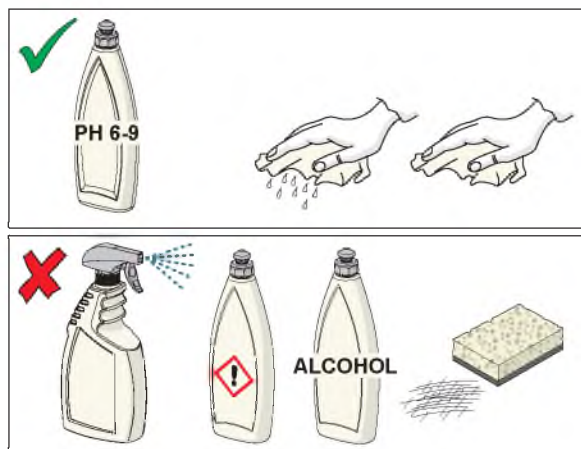
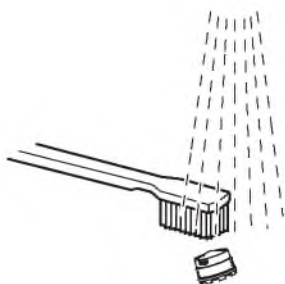

CLEANING.ORAS.COM



**7460 , 7460X-100 , 7460U , 7460X , 7460L ,
7452U, 7461 , 7484 , 7464 , 7464L , 7466 ,
7446X , 7420 , 7429 , 7413 , 7413U**

- 1 602430V
- 2 109898
- 3 198094/2 (SE)
- 3 178375V
- 4 602431V
- 5 178796V
- 6 178780V

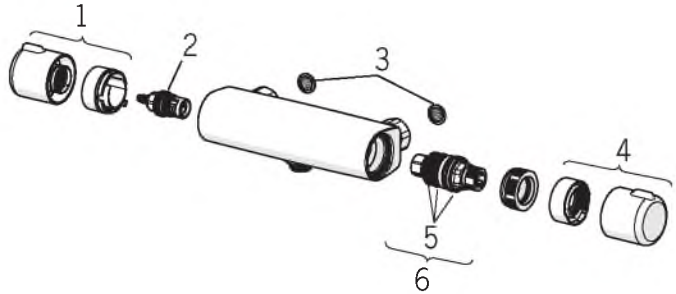

**7462, 7462G, 7462U, 7462X, 7445,
7443, 7414, 7414U, 7453**

- 1 602452V
- 2 601278V
- 3 178375V
- 3 198094/2 (SE)
- 4 602431V
- 5 178796V
- 6 178780V
- 7 158556
- 7 600654V (7462G)

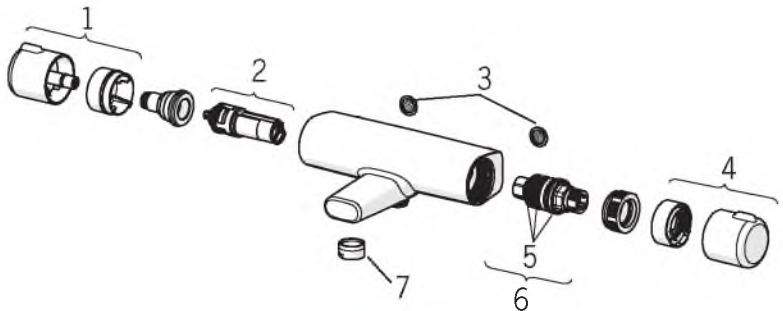

7470U , 7470X , 7471 , 7442U ,
7447X

- 1 602431V
- 2 109898
- 3 198094/2
- 3 178375V
- 4 602430V
- 5 178796V
- 6 178780V

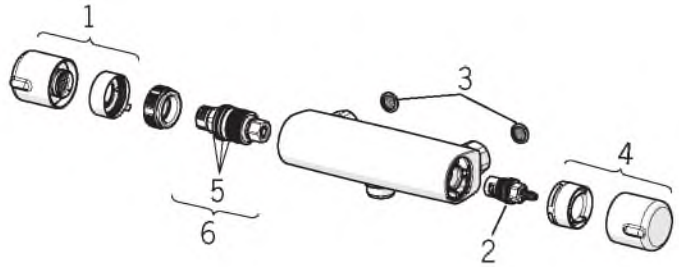

7469

- 1 602430V
- 2 109898
- 3 178375V
- 4 602602V
- 5 178796V
- 6 178780V

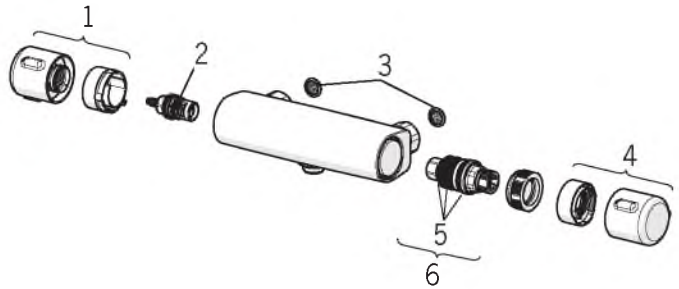

Oras Group is a powerful European provider of sanitary fittings: the market leader in the Nordics and a leading company in Continental Europe. The company's mission is to make the use of water easy and sustainable and its vision is to become the European leader of advanced sanitary fittings. Oras Group has two strong brands, Oras and Hansa.

The head office of the Group is located in Rauma, Finland, and the Group has three manufacturing sites: Kralovice (Czech Republic), Olesno (Poland) and Rauma (Finland). Oras Group employs approximately 1400 people in twenty countries. Oras Group is owned by Oras Invest, a family company and an industrial owner.

ORAS GROUP

Isometsäntie 2, P.O. Box 40

FI-26101 Rauma

Tel. +358 2 83 161

Fax +358 2 831 6300

info.finland@oras.com

www.oras.com

