

- DE** Montageanleitung  
**FR** Instructions de montage  
**EN** assembly instructions  
**IT** Istruzioni per Installazione  
**ES** Instrucciones de montaje  
**NL** Handleiding  
**DK** Monteringsvejledning  
**PT** Manual de Instalação  
**PL** Instrukcja montażu  
**CS** Montážní návod  
**SK** Montážny návod  
**ZH** 组装说明  
**RU** Инструкция по монтажу  
**HU** Szerelési útmutató  
**FI** Asennusohje  
**SV** Monteringsanvisning  
**LT** Montavimo instrukcijos  
**HR** Uputstva za instalaciju  
**TR** Montaj kılavuzu  
**RO** Instrucțiuni de montare  
**EL** Οδηγία συναρμολόγησης  
**SL** Navodila za montažo  
**ET** Paigaldusjuhend  
**LV** Montāžas instrukcija  
**SR** Uputstvo za montažu  
**NO** Montasjeveiledning  
**BG** Инструкция за употреба  
**SQ** Udhëzime rreth montimit  
**AR** تعليمات التجميع

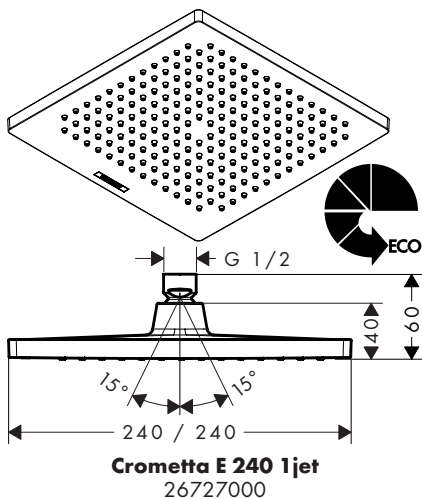
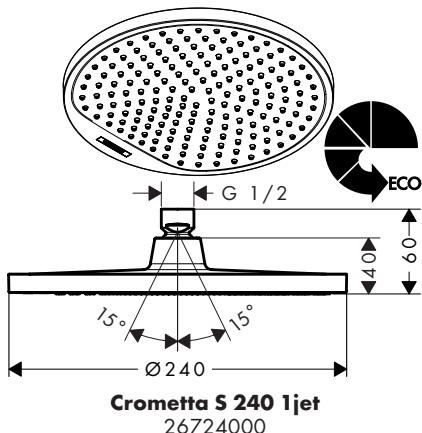

**P**

max.  
0,6 MPa  
6 bar

0,1 - 0,4 MPa  
1 - 4 bar

**T**

max.  
60 °C

< 50 °C

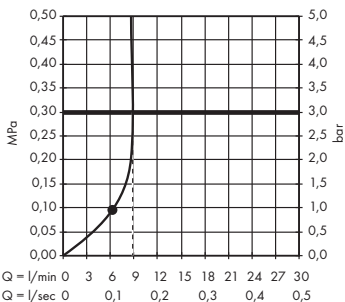

**Crometta S 240 1jet** 26724000

**Crometta E 240 1jet** 26727000

	P-IX	DVGW	SVGW	ACS	WRAS	NF	KIWA
<b>26724000</b>					X		X
<b>26727000</b>					X		X

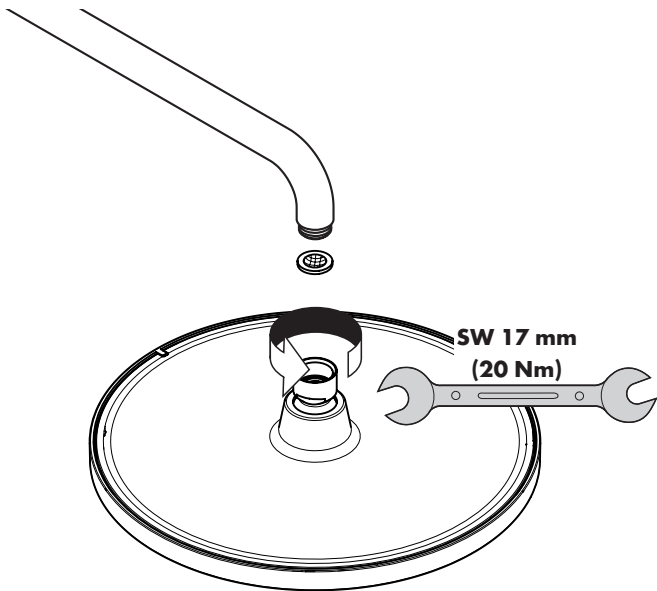

94246000

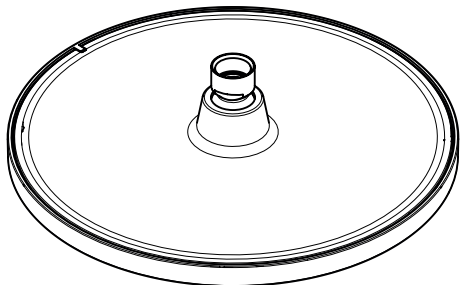

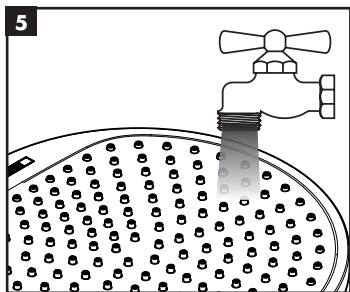
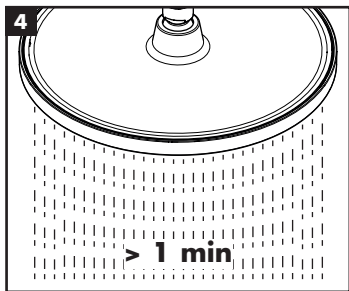
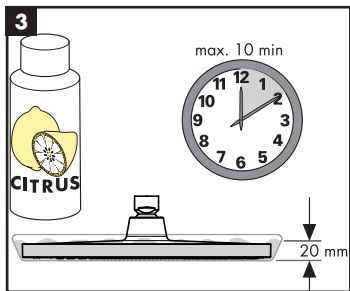
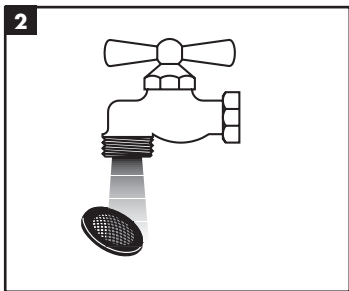
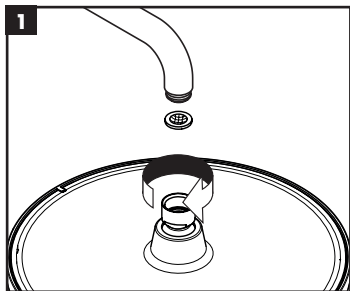

**hansgrohe**

Hansgrohe · Auestraße 5 · 9 · D-77761 Schiltach  
Telefon +49 (0) 78 36/51-1282 · Telefax +49 (0) 7836/511440  
E-Mail: info@hansgrohe.com · Internet: www.hansgrohe.com

12/2016  
9.01301.01